

### Features

- Suited for DC/DC converts
- Low losses
- High  $T_j$
- High surge current capability
- High energy avalanche capability
- 1 mm package thickness
- ECOPACK<sup>®</sup>2 compliant component

### Description

High performance diode suited for high frequency DC to DC converters. Packaged in PowerFLAT<sup>™</sup> 5x6, this device is intended for use in low voltage high frequency inverters.

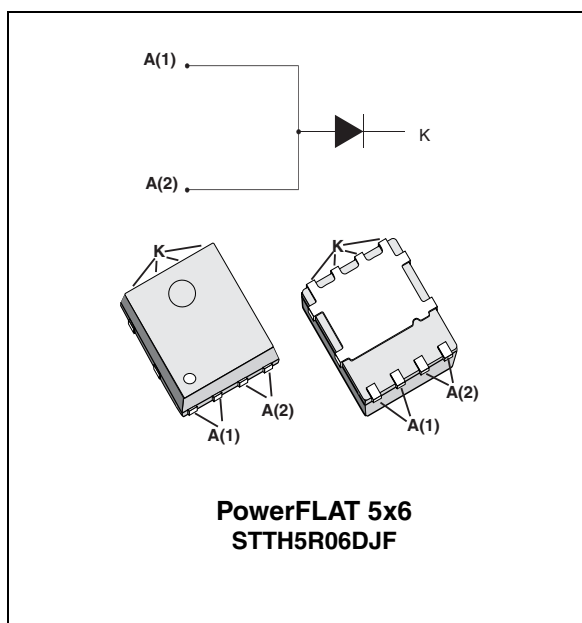

**Table 1. Device summary**

Symbol	Value
$I_{F(AV)}$	5 A
$V_{RRM}$	600 V
$T_j$	175 °C
$V_F$ (typ)	0.95 V
$t_{rr}$ (typ)	30 ns

TM: PowerFLAT is a trademark of STMicroelectronics

# 1 Characteristics

**Table 2. Absolute ratings (limiting values with anode terminals short-circuited)**

Symbol	Parameter	Value	Unit
$V_{RRM}$	Repetitive peak reverse voltage	600	V
$I_{F(RMS)}$	Forward rms current	45	A
$I_{F(AV)}$	Average forward current	$T_c = 160\text{ °C}$ $\delta = 0.5$	A
$I_{FSM}$	Surge non repetitive forward current	$t_p = 10\text{ ms}$ sinusoidal	A
$T_{stg}$	Storage temperature range	-65 to + 175	°C
$T_j$	Maximum operating junction temperature	175	°C

**Table 3. Thermal parameter**

Symbol	Parameter	Maximum	Unit
$R_{th(j-c)}$	Junction to case	2.0	°C/W

**Table 4. Static electrical characteristics (anode terminals short-circuited)**

Symbol	Parameter	Test conditions	Min.	Typ	Max.	Unit	
$I_R^{(1)}$	Reverse leakage current	$T_j = 25\text{ °C}$			60	$\mu\text{A}$	
		$T_j = 125\text{ °C}$			60		600
$V_F^{(2)}$	Forward voltage drop	$T_j = 25\text{ °C}$	$I_F = 5\text{ A}$		1.55	2.00	V
		$T_j = 125\text{ °C}$			0.95	1.20	

1. Pulse test:  $t_p = 5\text{ ms}$ ,  $\delta < 2\%$

2. Pulse test:  $t_p = 380\text{ }\mu\text{s}$ ,  $\delta < 2\%$

To evaluate the maximum conduction losses use the following equation:

$$P = 0.9 \times I_{F(AV)} + 0.06 I_{F(RMS)}^2$$

**Table 5. Recovery characteristics**

Symbol	Parameter	Test conditions		Min.	Typ	Max.	Unit
$t_{rr}$	Reverse recovery time	$T_j = 25\text{ }^\circ\text{C}$	$I_F = 1\text{ A}$ $V_r = 30\text{ V}$ $di_F/dt = -100\text{ A}/\mu\text{s}$		30	40	ns
			$I_F = 1\text{ A}$ $V_r = 30\text{ V}$ $di_F/dt = -50\text{ A}/\mu\text{s}$		40	55	
$I_{RM}$	Reverse recovery current	$T_j = 125\text{ }^\circ\text{C}$	$I_F = 5\text{ A}$ , $di_F/dt = -200\text{ A}/\mu\text{s}$ , $V_R = 400\text{ V}$		6.0	8.0	A
$S_{factor}$	Reverse recovery softness factor				0.5		-
$Q_{rr}$	Reverse recovery charges				180		nC

**Table 6. Turn-on switching characteristics**

Symbol	Parameter	Test conditions		Min.	Typ	Max.	Unit
$t_{fr}$	Forward recovery time	$T_j = 25\text{ }^\circ\text{C}$	$I_F = 5\text{ A}$ $di_F/dt = -100\text{ A}/\mu\text{s}$ $V_{FR} = 1.6\text{ V}$			150	ns
$V_{FP}$	Forward recovery voltage				2.3	3.5	V

**Figure 1. Average forward power dissipation versus average forward current**      **Figure 2. Forward voltage drop versus forward current**

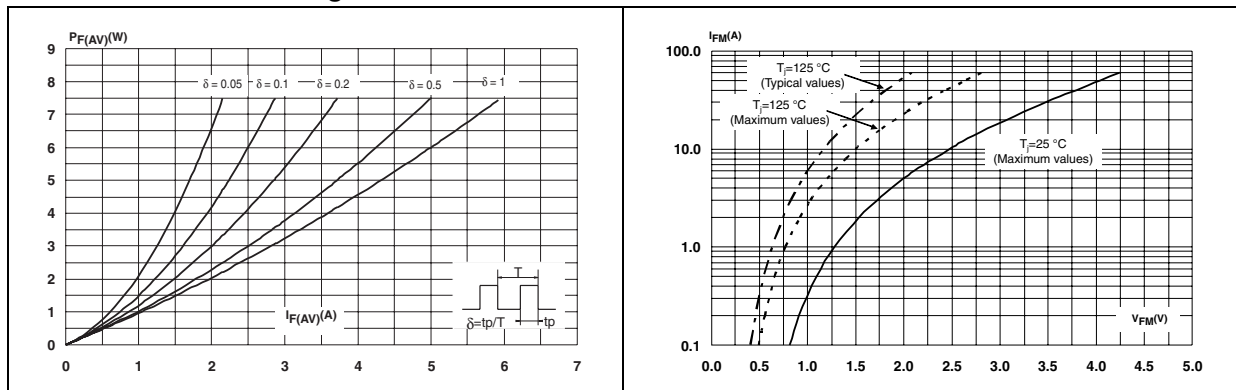

**Figure 3. Relative variation of thermal impedance junction to case versus pulse duration**

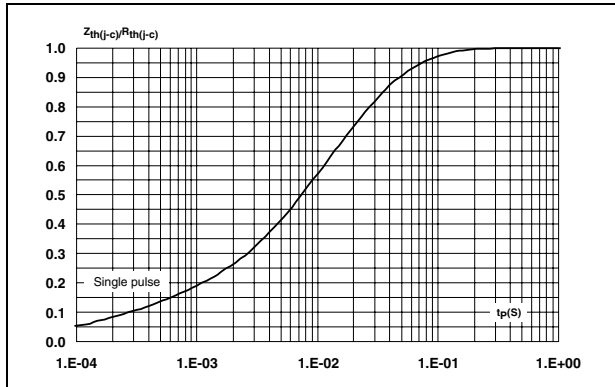

**Figure 4. Peak reverse recovery current versus  $di_F/dt$  (typical values)**

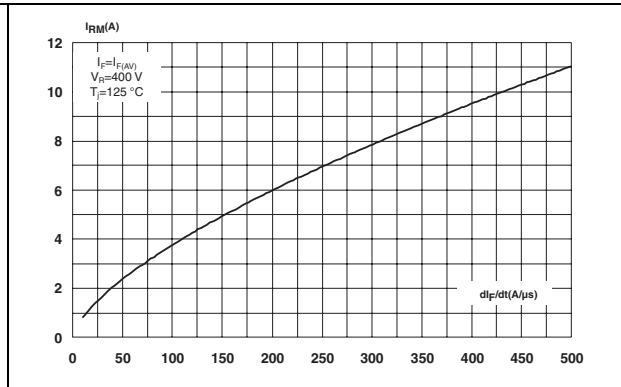

**Figure 5. Reverse recovery time versus  $di_F/dt$  (typical values)**

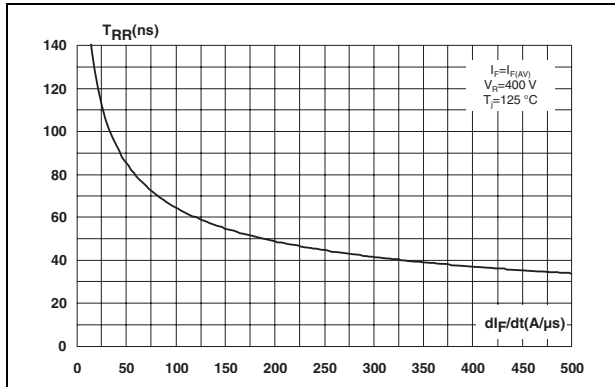

**Figure 6. Reverse recovery charges versus  $di_F/dt$  (typical values)**

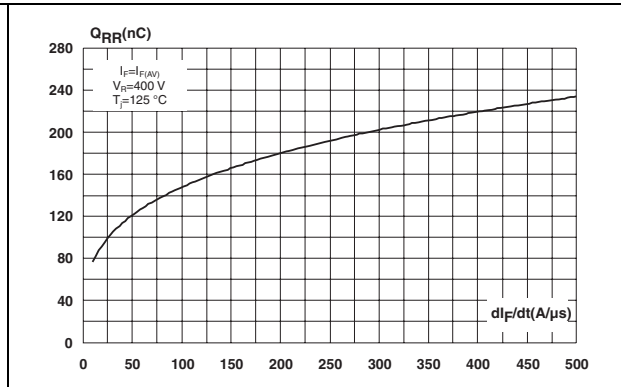

**Figure 7. Softness factor versus  $di_F/dt$  (typical values)**

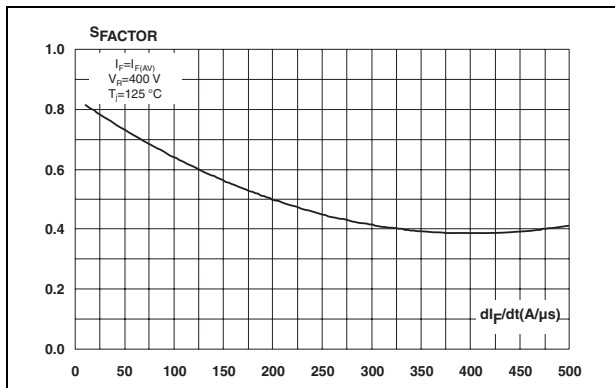

**Figure 8. Relative variations of dynamic parameters versus junction temperature**

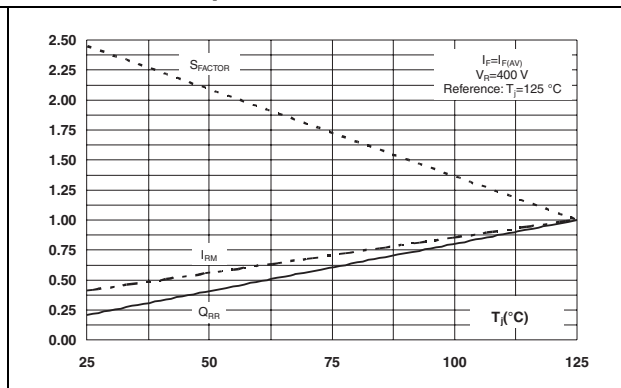

Figure 9. Transient peak forward voltage versus  $di_F/dt$  (typical values)

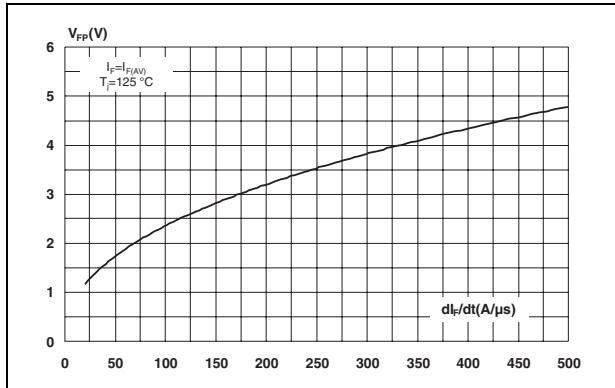

Figure 10. Forward recovery time versus  $di_F/dt$  (typical values)

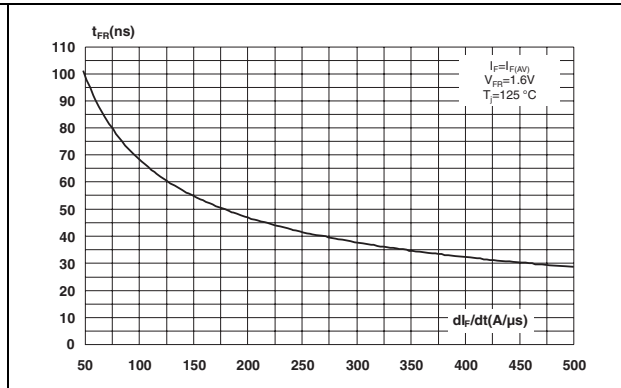

Figure 11. Junction capacitance versus reverse voltage applied (typical values)

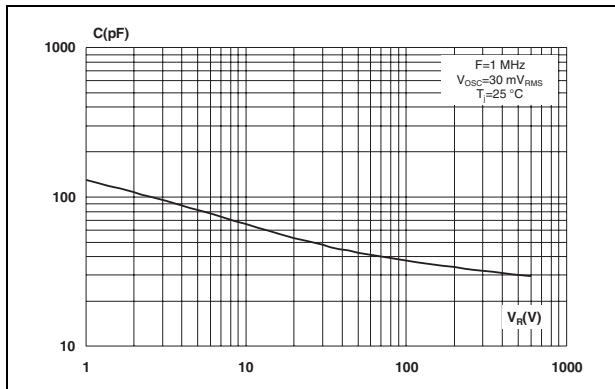
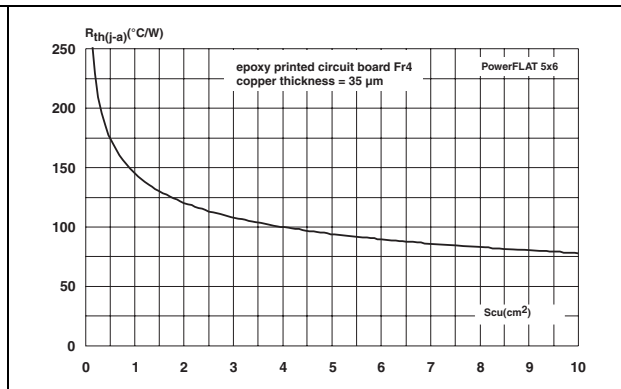

Figure 12. Thermal resistance junction to ambient versus copper surface under tab



## 2 Package information

- Epoxy meets UL94, V0
- Cooling method: by conduction (C)

In order to meet environmental requirements, ST offers these devices in different grades of ECOPACK® packages, depending on their level of environmental compliance. ECOPACK® specifications, grade definitions and product status are available at: [www.st.com](http://www.st.com). ECOPACK® is an ST trademark.

**Table 7. PowerFLAT 5x6 dimensions**

Ref.	Dimensions					
	Millimeters			Inches		
	Min.	Typ.	Max.	Min.	Typ.	Max.
A	0.80		1.00	0.031		0.039
A1	0.02		0.05	0.001		0.002
A2		0.25			0.010	
b	0.30		0.50	0.012		0.020
D		5.20			0.205	
D2	4.11		4.31	0.162		0.170
e		1.27			0.050	
E		6.15			0.242	
E2	3.50		3.70	0.138		0.146
L	0.50		0.80	0.020		0.031
K	1.275		1.575	0.050		0.062

**Figure 13. Footprint (dimensions in mm)**

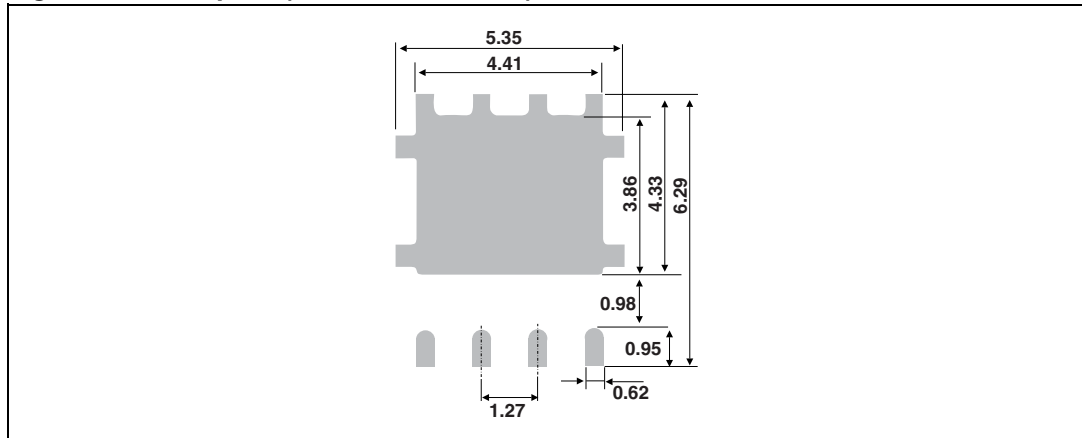
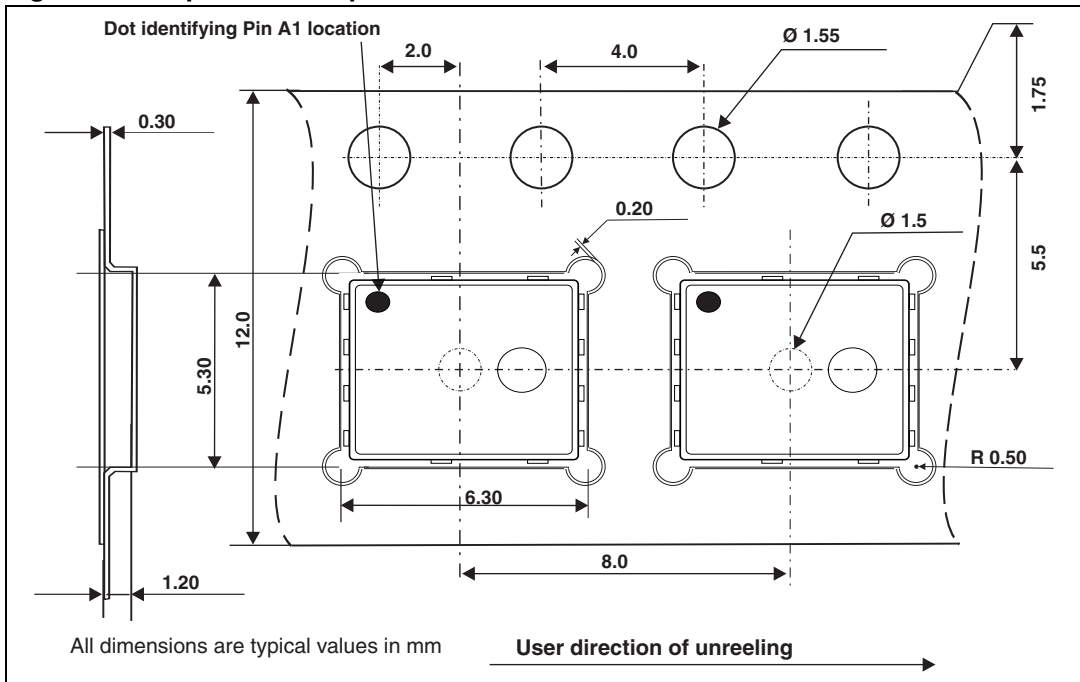

Figure 14. Tape and reel specifications



### 3 Ordering information

**Table 8. Other information**

Order code	Marking	Package	Weight	Base qty	Delivery mode
STTH5R06DJF-TR	TH5R 06	PowerFLAT 5x6	0.095 g	3000	Tape and Reel

### 4 Revision history

**Table 9. Document revision history**

Date	Revision	Changes
16-Mar-2012	1	First issue.



**Please Read Carefully:**

Information in this document is provided solely in connection with ST products. STMicroelectronics NV and its subsidiaries ("ST") reserve the right to make changes, corrections, modifications or improvements, to this document, and the products and services described herein at any time, without notice.

All ST products are sold pursuant to ST's terms and conditions of sale.

Purchasers are solely responsible for the choice, selection and use of the ST products and services described herein, and ST assumes no liability whatsoever relating to the choice, selection or use of the ST products and services described herein.

No license, express or implied, by estoppel or otherwise, to any intellectual property rights is granted under this document. If any part of this document refers to any third party products or services it shall not be deemed a license grant by ST for the use of such third party products or services, or any intellectual property contained therein or considered as a warranty covering the use in any manner whatsoever of such third party products or services or any intellectual property contained therein.

**UNLESS OTHERWISE SET FORTH IN ST'S TERMS AND CONDITIONS OF SALE ST DISCLAIMS ANY EXPRESS OR IMPLIED WARRANTY WITH RESPECT TO THE USE AND/OR SALE OF ST PRODUCTS INCLUDING WITHOUT LIMITATION IMPLIED WARRANTIES OF MERCHANTABILITY, FITNESS FOR A PARTICULAR PURPOSE (AND THEIR EQUIVALENTS UNDER THE LAWS OF ANY JURISDICTION), OR INFRINGEMENT OF ANY PATENT, COPYRIGHT OR OTHER INTELLECTUAL PROPERTY RIGHT.**

**UNLESS EXPRESSLY APPROVED IN WRITING BY TWO AUTHORIZED ST REPRESENTATIVES, ST PRODUCTS ARE NOT RECOMMENDED, AUTHORIZED OR WARRANTED FOR USE IN MILITARY, AIR CRAFT, SPACE, LIFE SAVING, OR LIFE SUSTAINING APPLICATIONS, NOR IN PRODUCTS OR SYSTEMS WHERE FAILURE OR MALFUNCTION MAY RESULT IN PERSONAL INJURY, DEATH, OR SEVERE PROPERTY OR ENVIRONMENTAL DAMAGE. ST PRODUCTS WHICH ARE NOT SPECIFIED AS "AUTOMOTIVE GRADE" MAY ONLY BE USED IN AUTOMOTIVE APPLICATIONS AT USER'S OWN RISK.**

Resale of ST products with provisions different from the statements and/or technical features set forth in this document shall immediately void any warranty granted by ST for the ST product or service described herein and shall not create or extend in any manner whatsoever, any liability of ST.

ST and the ST logo are trademarks or registered trademarks of ST in various countries.

Information in this document supersedes and replaces all information previously supplied.

The ST logo is a registered trademark of STMicroelectronics. All other names are the property of their respective owners.

© 2012 STMicroelectronics - All rights reserved

STMicroelectronics group of companies

Australia - Belgium - Brazil - Canada - China - Czech Republic - Finland - France - Germany - Hong Kong - India - Israel - Italy - Japan - Malaysia - Malta - Morocco - Philippines - Singapore - Spain - Sweden - Switzerland - United Kingdom - United States of America

[www.st.com](http://www.st.com)

