

THIS DRAWING IS UNPUBLISHED. RELEASED FOR PUBLICATION  
 © COPYRIGHT - By - ALL RIGHTS RESERVED.

REVISIONS				
P	LTR	DESCRIPTION	DATE	APVD
E		REVISED PER ECO-18-001882	13FEB2018	AP DG

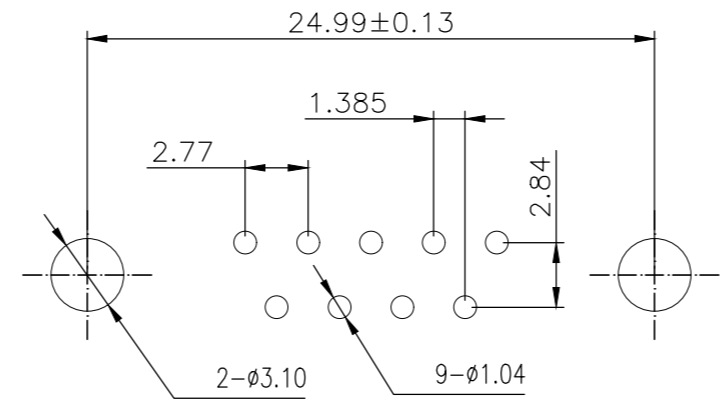
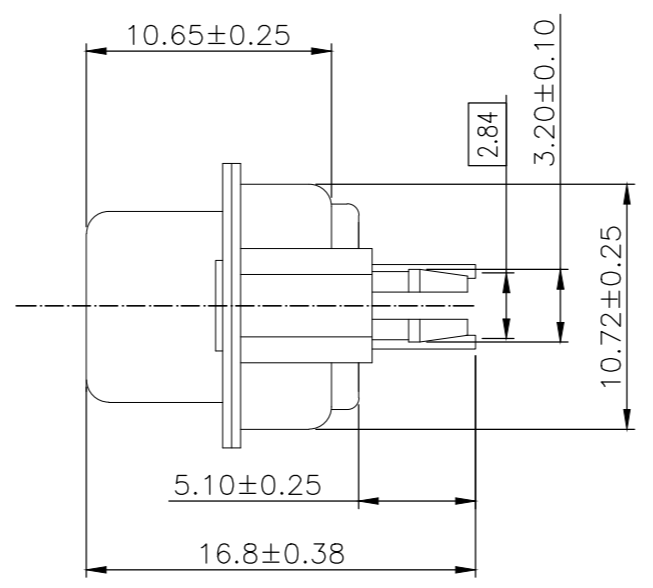
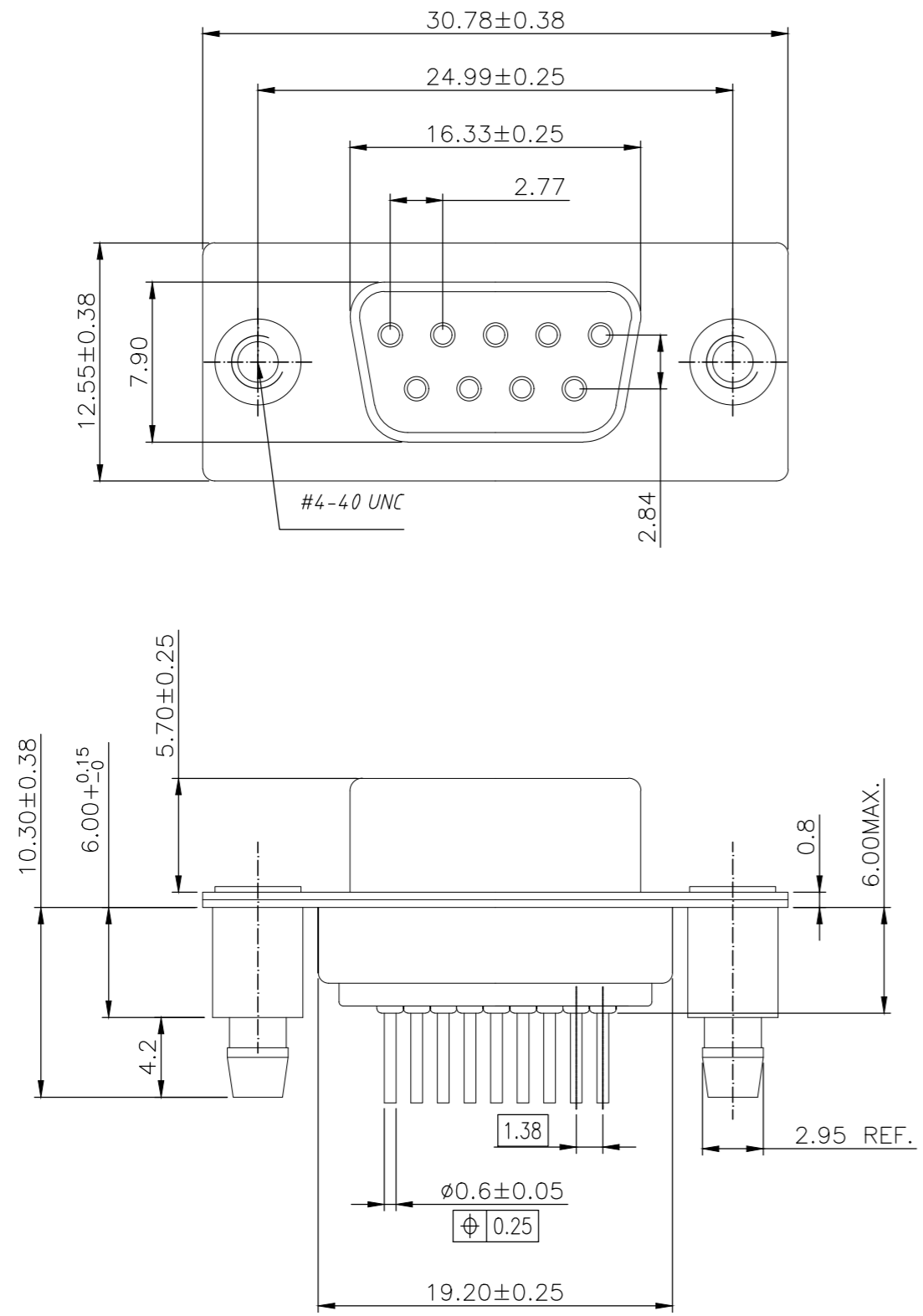

RECOMMENDED PCB LAYOUT

NOTE:

1. MATERIAL:  
 HOUSING: PBT WITH 20% GF UL 94 V-0, BLACK COLOR  
 CONTACTS: PHOSPHOR BRONZE.  
 SHELL: STEEL.  
 SCREW: BRASS.  
 SCREW LOCK: BRASS.  
 SCREW TORQUE: 5kgf-cm MAX.
2. FINISH:  
 CONTACTS: GOLD PLATED ON CONTACT AREA,  
 0.375µm [15µ"] MIN. MATTE TIN ON SOLDER TAIL  
 2.54µm [100µ"], WITH ENTIRE CONTACT  
 UNDERPLATED 1.27µm [50µ"] MIN. NICKEL.  
 FRONT SHELL: 2.54µm [100µ"] MIN. NICKEL PLATED.  
 REAR SHELL: 1.27µm [50µ"] MIN NICKEL UNDERPLATE.  
 2.54µm [100µ"] MIN BRIGHT TIN PLATE  
 SCREW LOCK: 1.27µm [50µ"] MIN. NICKEL PLATED.  
 BOARD LOCK: 1.27µm [50µ"] MIN NICKEL UNDERPLATE.  
 1.27µm [50µ"] MIN MATTE TIN PLATE
3. WAVE SOLDER CAPABLE TO 265°C PER TE TEST SPEC.  
 109-202, CONDITION B.

2301838

THIS DRAWING IS A CONTROLLED DOCUMENT.		DWN AJITH PAI 06FEB2017	9w D skt W B/L & 4-40 inserts 15u" gold		2301838-1
DIMENSIONS: mm		CHK DAN GORENC 06FEB2017	DESCRIPTION		TE PART NO
TOLERANCES UNLESS OTHERWISE SPECIFIED:		APVD - 06FEB2017			D-SUB VERTICAL 9P SKT CONNECTOR
0 PLC ± - 1 PLC ± 0.25 2 PLC ± 0.15 3 PLC ± - 4 PLC ± - ANGLES ± -		PRODUCT SPEC 108-130013			
MATERIAL		FINISH	SIZE A2	CAGE CODE 00779	DRAWING NO C=2301838
-		-	SCALE 1:1		SHEET 1 of 4
CUSTOMER DRAWING		WEIGHT 0	RESTRICTED TO		REV E

THIS DRAWING IS UNPUBLISHED. RELEASED FOR PUBLICATION  
 © COPYRIGHT - By - ALL RIGHTS RESERVED.

REVISIONS					
P	LTR	DESCRIPTION	DATE	DWN	APVD
-	-	SEE SHEET 1	-	-	-

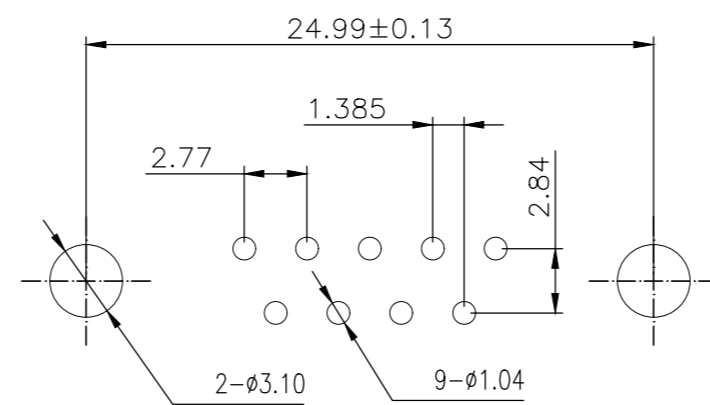
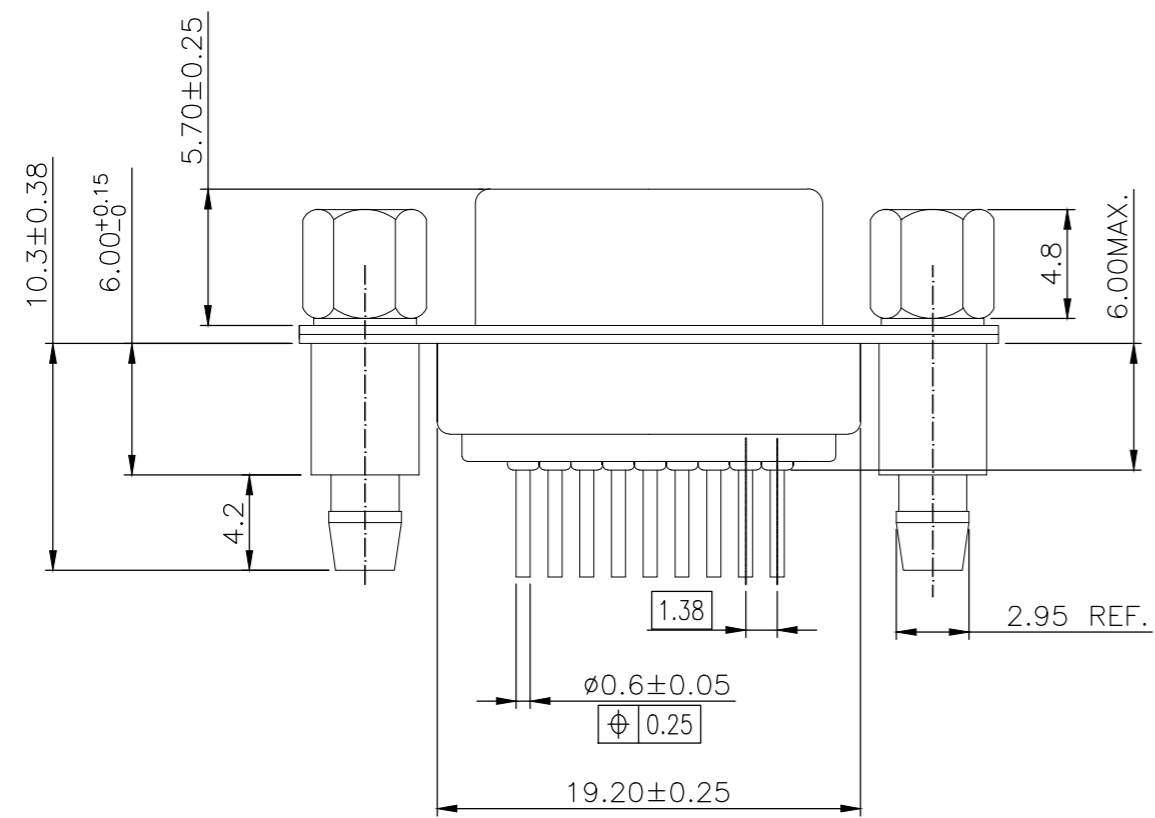
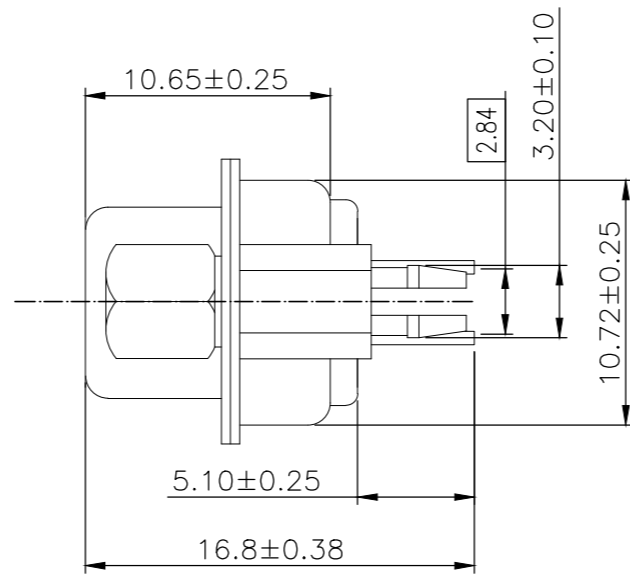
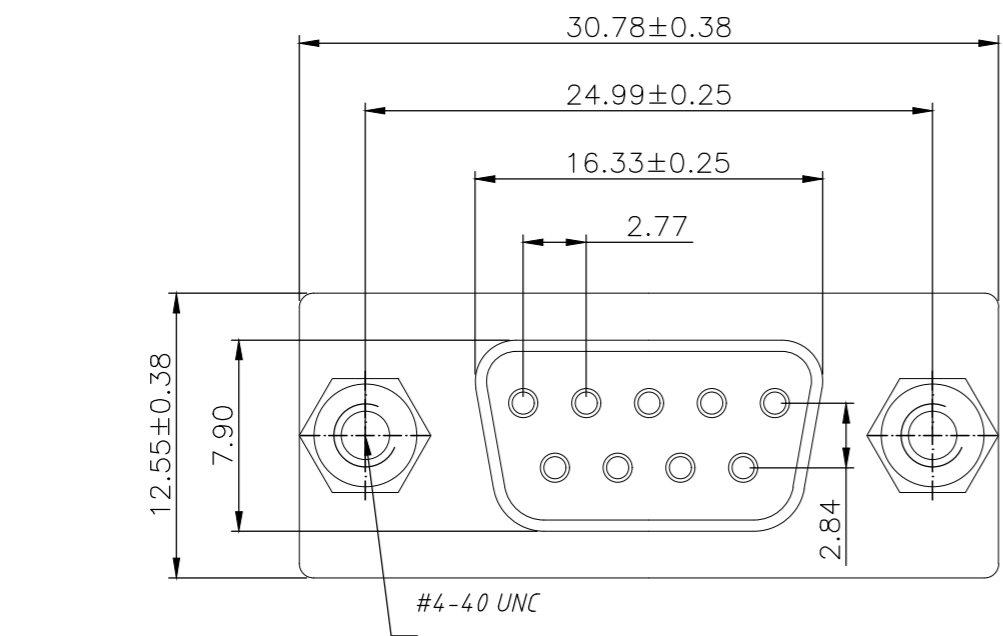

RECOMMENDED PCB LAYOUT

2301838

THIS DRAWING IS A CONTROLLED DOCUMENT.		DWN	AJITH PAI	06FEB2017
DIMENSIONS: mm		CHK	DAN GORENC	06FEB2017
TOLERANCES UNLESS OTHERWISE SPECIFIED:		APVD	-	06FEB2017
0 PLC ± -		PRODUCT SPEC	108-130013	
1 PLC ± 0.25		APPLICATION SPEC	-	
2 PLC ± 0.15		WEIGHT	0	
3 PLC ± -		CUSTOMER DRAWING	SCALE 1:1 SHEET 2 of 4 REV E	
4 PLC ± -				
ANGLES ± -				
FINISH				

9w D skt W B/L & 4-40 s/lock 15u" gold		2301838-2	
DESCRIPTION		TE PART NO	
<b>TE</b> TE Connectivity			
D-SUB VERTICAL 9P SKT CONNECTOR			
SIZE	CAGE CODE	DRAWING NO	RESTRICTED TO
A2	00779	C=2301838	-

THIS DRAWING IS UNPUBLISHED. RELEASED FOR PUBLICATION  
 © COPYRIGHT - By - ALL RIGHTS RESERVED.

REVISIONS					
P	LTR	DESCRIPTION	DATE	DWN	APVD
-	-	SEE SHEET 1	-	-	-

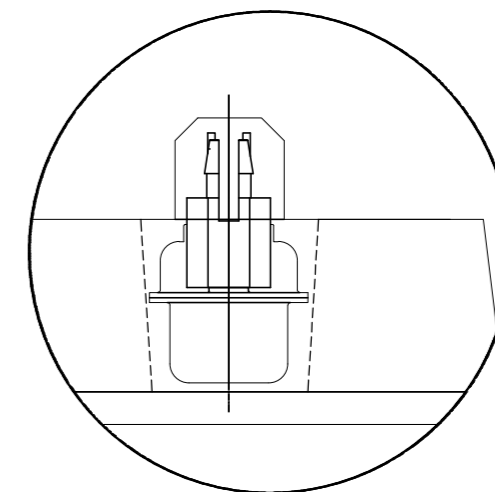
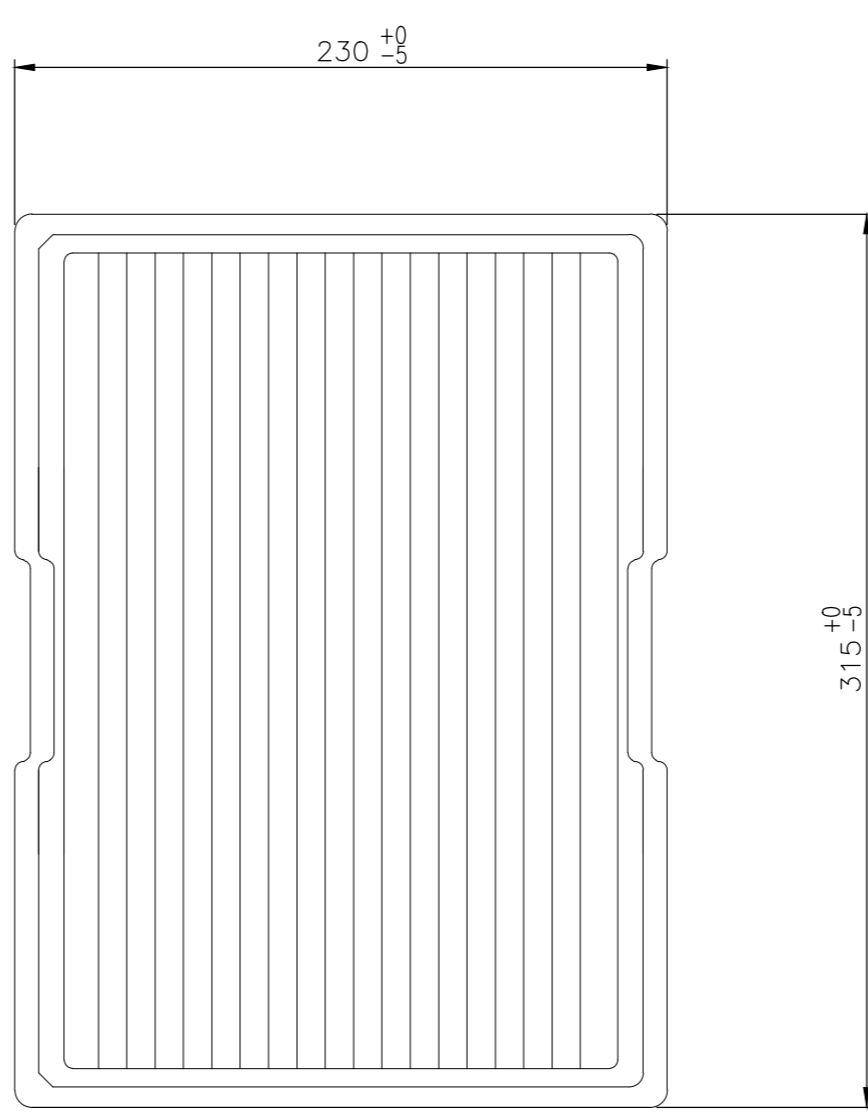
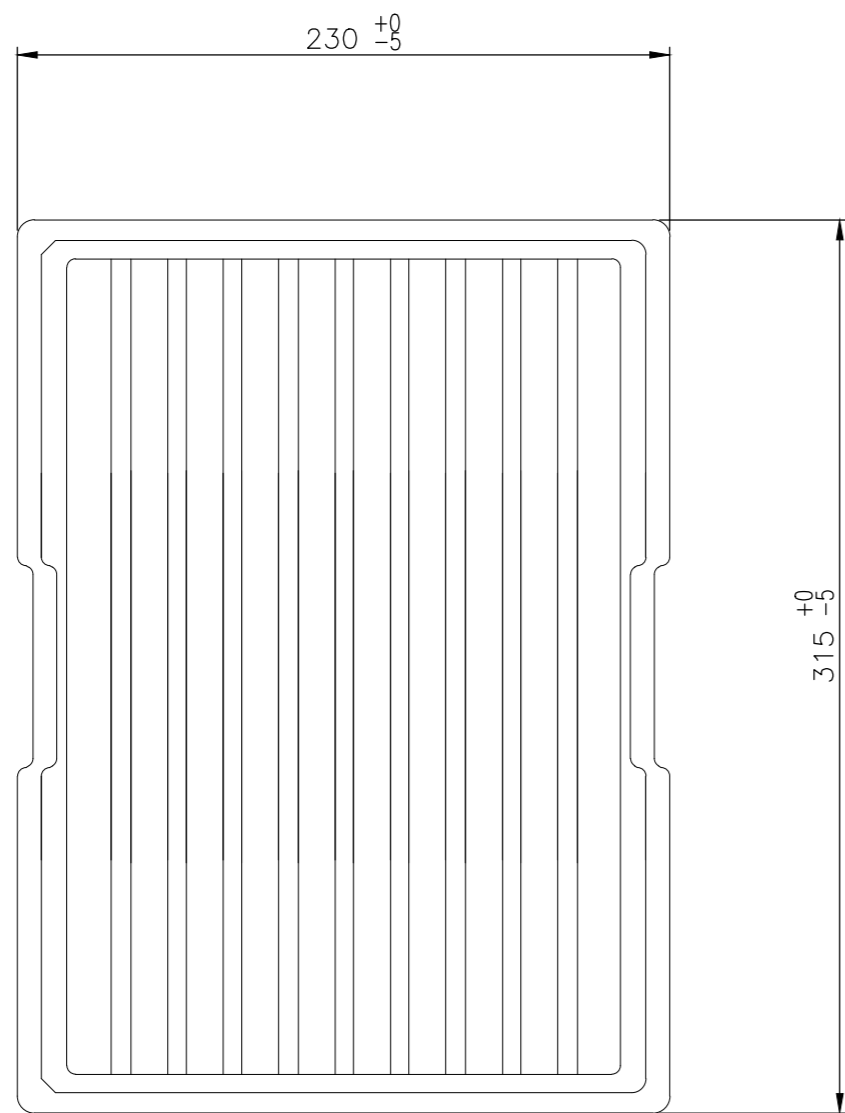
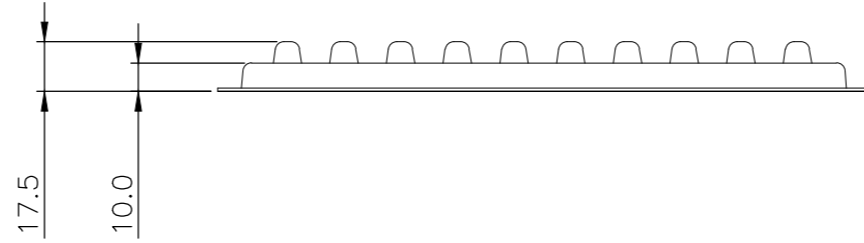
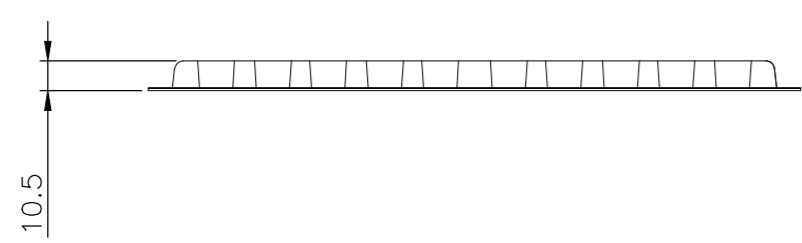

DETAIL A

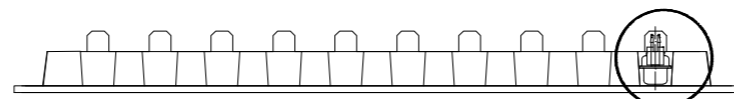

SEE DETAIL A

2301838

THIS DRAWING IS A CONTROLLED DOCUMENT.		DWN AJITH PAI 06FEB2017			
DIMENSIONS: mm		CHK DAN GORENC 06FEB2017			
TOLERANCES UNLESS OTHERWISE SPECIFIED:		APVD - 06FEB2017	NAME D-SUB VERTICAL 9P SKT CONNECTOR		
0 PLC ± - 1 PLC ± 0.25 2 PLC ± 0.15 3 PLC ± - 4 PLC ± - ANGLES ± -		PRODUCT SPEC 108-130013	SIZE A2	CAGE CODE 00779	DRAWING NO C=2301838
MATERIAL -		FINISH -	WEIGHT 0	RESTRICTED TO -	
CUSTOMER DRAWING			SCALE 1:1	SHEET 3 of 4	REV E

THIS DRAWING IS UNPUBLISHED. RELEASED FOR PUBLICATION  
 © COPYRIGHT - By - ALL RIGHTS RESERVED.

REVISIONS					
P	LTR	DESCRIPTION	DATE	DWN	APVD
-	-	SEE SHEET 1	-	-	-

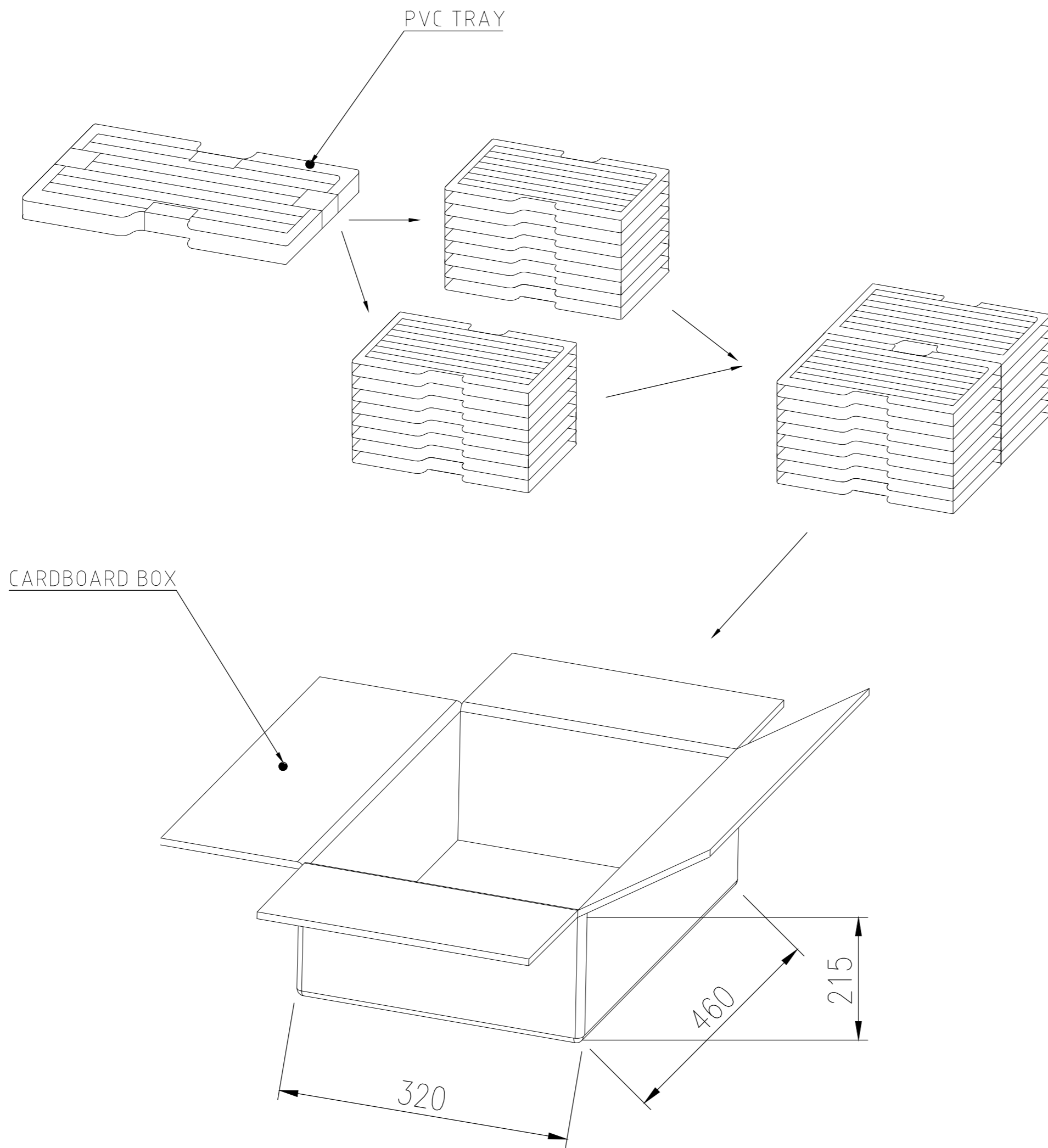

16.979	14.400	90	20	1800	2301838-2
14.279	11.700	90	20	1800	2301838-1
GROSS WEIGHT (Kg)	NET WEIGHT (Kg)	PCS/TRAY	TRAYS /CARTON	QUANTITY PCS	PART NUMBER

THIS DRAWING IS A CONTROLLED DOCUMENT.		DWN AJITH PAI 06FEB2017			
DIMENSIONS: mm		CHK DAN GORENC 06FEB2017			
TOLERANCES UNLESS OTHERWISE SPECIFIED:		APVD - 06FEB2017	NAME		
0 PLC ± -		PRODUCT SPEC	D-SUB VERTICAL		
1 PLC ± 0.25		108-130013	9P SKT CONNECTOR		
2 PLC ± 0.15		APPLICATION SPEC	-		
3 PLC ± -		-	SIZE	CAGE CODE	DRAWING NO
4 PLC ± -		WEIGHT	A2	00779	C=2301838
ANGLES ± -		CUSTOMER DRAWING	SCALE	SHEET	REV
FINISH		-	1:1	4 of 4	E
MATERIAL		-	RESTRICTED TO		