

## GKS Series

### Multi-Entry Trapped Key-Operated Safety Interlock Switch



#### DESCRIPTION

The introduction of the GKS product marks a significant new product class for Honeywell. Honeywell's switching expertise has been applied to a cost-effective, trapped key safety interlock switch. This product allows OEMs to hold a door or gate closed while a hazard still exists. This is particularly important where there is momentum in the machine. In other words, when the machine is signaled to stop, the momentum in

the machine can mean that parts of the machine are still moving and pose an injury risk if the access gate or door is not held closed. Global approvals and standards are important to Honeywell's customers; therefore, the GKS product conform to the requirements of IEC60947-5-1 and carries cULus, CE and CCC approvals.

#### FEATURES

- Global approvals (CE, cULus, CE, and CCC)
- Glass-filled polyester body
- Power-to-lock and power-to-unlock schemes for key trap
- Flexible switching arrangement
- 24 Vdc, 110 Vac, and 230 Vac coil voltages
- Over-ride mechanism in cover
- Head may be rotated into 4 different positions
- Three conduit openings (knock-out style)
- Switch position provides status

#### BENEFITS

- Product may be applied to most applications worldwide
- Tough, cost-effective, double-insulated enclosure
- Choice of key trapping methodology
- Four contacts that can be arranged in any configuration<sup>1</sup>
- Multiple voltages provide for every geography
- Has a method to open door (in case of power loss, etc.)
- One part number may be used for multiple applications
- Flexible wiring options
- Can diagnose status of gate/door (gate/door closed and locked, gate/door closed and unlocked, gate/door open)

<sup>1</sup> There will be minimum volume requirements for unreleased options.

#### POTENTIAL APPLICATIONS

- Woodworking machinery
- Printing/paper finishing equipment
- Plastic molding equipment
- Packaging machinery
- Bailing
- Pumping equipment
- Semiconductor manufacturing equipment
- Packaging wrapping
- Specialty equipment
- Machine tool
- Robot cell

# GKS Series

## SPECIFICATIONS

Designation and Utilization Category		Rated Operational Current Ie (A) at Rated Operational Voltage Ue (V)		
		120 Vac	125 Vdc	240 Vac/250 Vdc
AC15	B300	3 A	–	1.5 A
DC13	Q300	–	0,55 A	0,27 A
<b>Rated thermal current (Ith)</b>		5 A		
<b>Sealing</b>		IP67; NEMA 1, 4, 12, 13		
<b>Rated impulse withstand (Uimp)</b>		2500 V		
<b>Pollution degree</b>		3 (macro-environment, installation environment)		
<b>Rated insulation voltage (Ui)</b>		600 V		
<b>Operating temperature range</b>		-25 °C to 50 °C [-13 °F to 122 °F]		
<b>Storage temperature range</b>		-40 °C to 85 °C [-40 °F to 185 °F]		
<b>Short-circuit protective device (type/maximum rating)</b>		Class J fuse (5 A/600 Vac)		
<b>Expected mechanical life</b>		1,000,000 operations		
<b>Conditional short-circuit current</b>		1000 A		
<b>Solenoid operating voltage and power</b>		24 Vac: +10 %, -15 %, 4 W      230 Vac: +10 %, -15 %, 9 W 110 Vac: +10 %, -15 %, 8 W      24 Vdc: +10 %, -20 %, 7 W		

Complies with:

Low Voltage Directive 73/23/EEC, as amended by directive 93/68/EEC.

Machinery Directive 98/37/EEC only as the directives relate to the components being used in a safety function.

IEC/EN60947-5-1.

## PART NUMBER TREE

GKS	X	XX	X	X	X	X
<b>Series</b>	<b>Conduit</b>	<b>Contacts</b>	<b>Head Orientation</b>	<b>Locking Principal</b>	<b>Solenoid Voltage</b>	<b>Additional Function</b>
Door Interlock Safety Limit Switch, Solenoid	A - 1/2 NPT C - M20	21 - 2NC/1NO/1NO 22 - 2NC/1NO/1NC 46 - 3NC/1NO 47 - 4NC	L - Front N - Back P - Left M - Right	A - Power to unlock S - Power to lock	2 - 24 Vac/dc 5 - 110 Vac 6 - 230 Vac	L - LED

**NOTE:** The part number tree is provided to demonstrate the potential combinations of components. Actual availability of individual product combinations will depend on the popularity of that type. Please check with your local distributor or Honeywell representative for the available types in your region.

## LED OPTION

The built-in LED is suitable for direct installation in the M20 x 1.5/0.5 in NPT thread, one of the three cable entries in the GKS safety switch. The built-in LED can indicate to the user whether the solenoid is unlocked/locked or whether the door is open/closed. The switching element can be wired individually.

Parameter	Value
<b>LED color</b>	Red
<b>Connection</b>	2 connection cables
<b>Screw-in thread</b>	M20 x 1.5/ 0.5 in NPT
<b>Operating voltage/current consumption</b>	24 Vdc/45 Ma 115 Vac/15 mA 230 Vac/15 mA
<b>Degree of protection</b>	IP67

# Multi-Entry Trapped Key-Operated Safety Interlock Switch

## MOUNTING DIMENSIONS (SWITCH AND OPTIONAL LED)

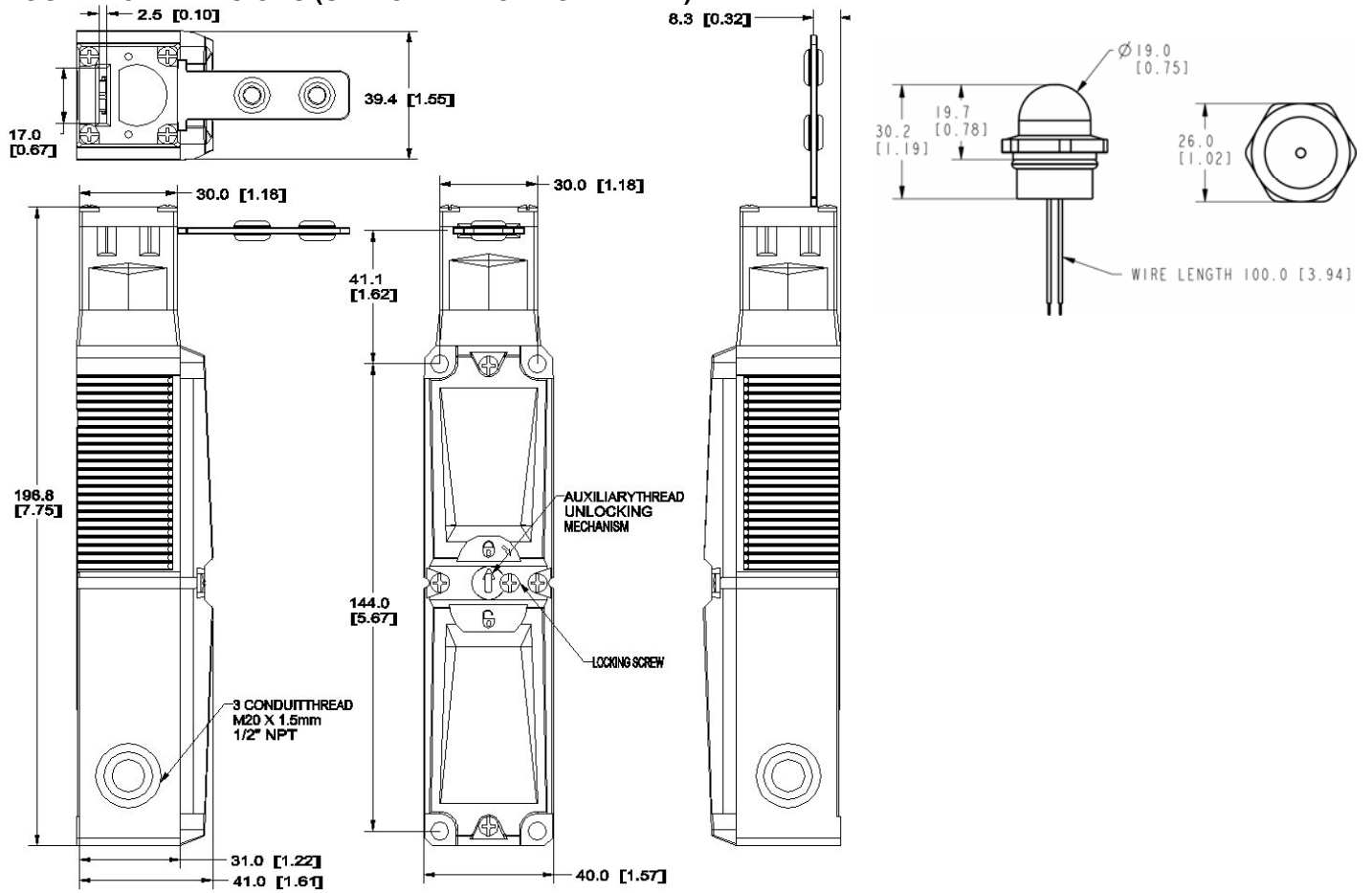

# GKS Series

## SWITCH ORDER GUIDE (ACTIVE LISTINGS)

Catalog Listing	Description
GKSA46LA2	0.5 in conduit, 3NC/1NO, head to front, power to unlock, 24 Vdc solenoid
GKSA46LA5	0.5 in conduit, 3NC/1NO, head to front, power to unlock, 110 Vac solenoid
GKSC46LA2	20 mm conduit, 3NC/1NO, head to front, power to unlock, 24 Vdc solenoid
GKSC46LA6	20 mm conduit, 3NC/1NO, head to front, power to unlock, 230 Vac solenoid

## KEY ORDER GUIDE (ACTIVE LISTINGS)

Catalog Listing	Description	Min. Actuating Radius
GKZS6	Straight key	min. R 160 [6.30]
GKZS7	90° key	min. R 160 [6.30]
GKZS8	Left-right adjustable key	min. R 32 [1.26]
GKZS4	Up-down adjustable key	min. R 45 [1.77]
GKZS9	Multidirectional key	Moveable max. 18 degrees
GKZSF	Funnel key	min. R 160 [6.30]

## CIRCUIT AND TRAVEL DIAGRAMS

Circuit Drawing	Inserted & Locked	Inserted & Unlocked	Removed & Unlocked
GKS..21..	13	13	13
	21	21	21
	33	33	33
	41	41	41
GKS..22..	11	11	11
	21	21	21
	33	33	33
	41	41	41
GKS..46..	13	13	13
	21	21	21
	31	31	31
	41	41	41
GKS..47..	11	11	11
	21	21	21
	31	31	31
	41	41	41

**NOTE:** This 'truth table' shows the switch status in various conditions. In each column, there is a change in switch contact position from the previous column. It is possible to determine the status of the switch by examining the combination against the table. This can be essential for operational reasons. For instance, the machine should not be started until the key is not only in the head, but is also trapped.

The **first column** depicts the key inserted and the key trapped in that position – this would be the typical run position for the machine – all doors closed. The **second column** illustrates the key inserted, but not trapped – this would be the safe-to-open the door position (as determined by the application's safety scheme). The **third column** shows the key extracted or door-open position.

# Multi-Entry Trapped Key-Operated Safety Interlock Switch

## KEY DIMENSIONS

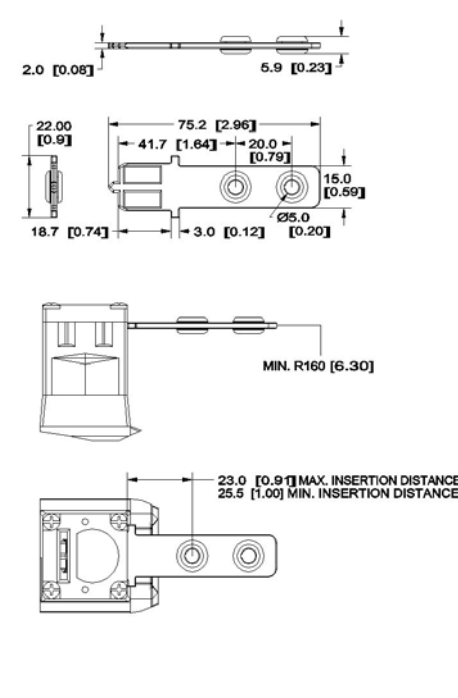
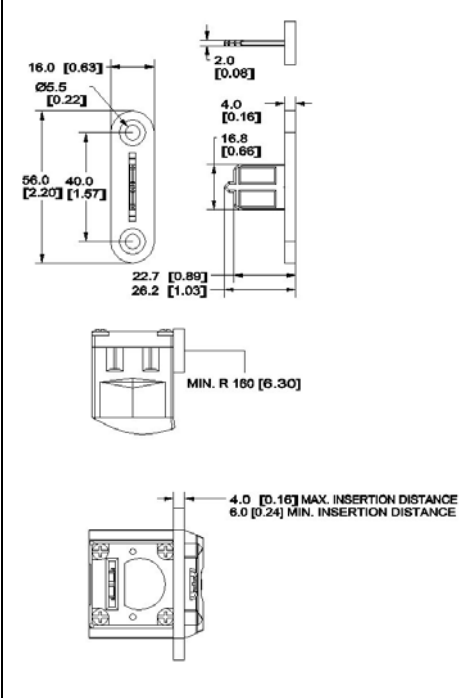
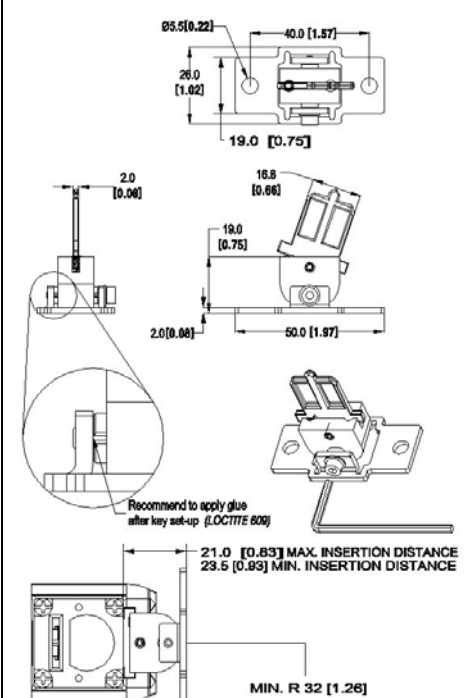
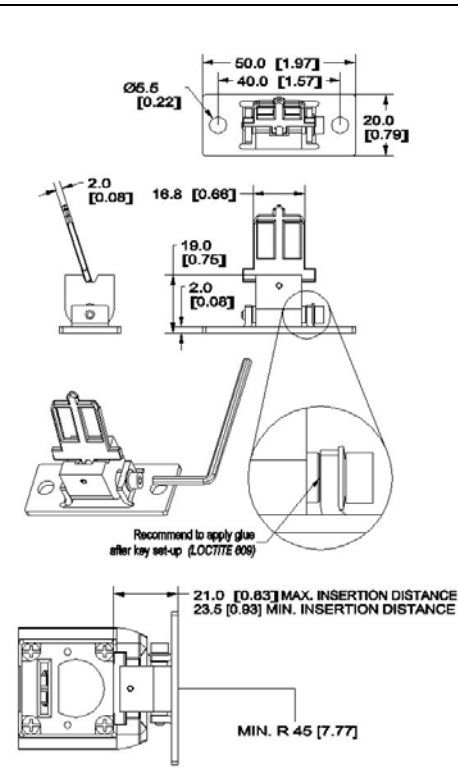
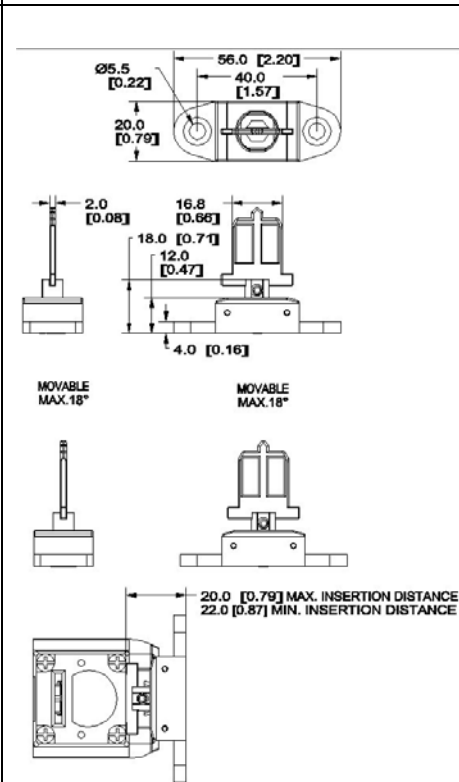
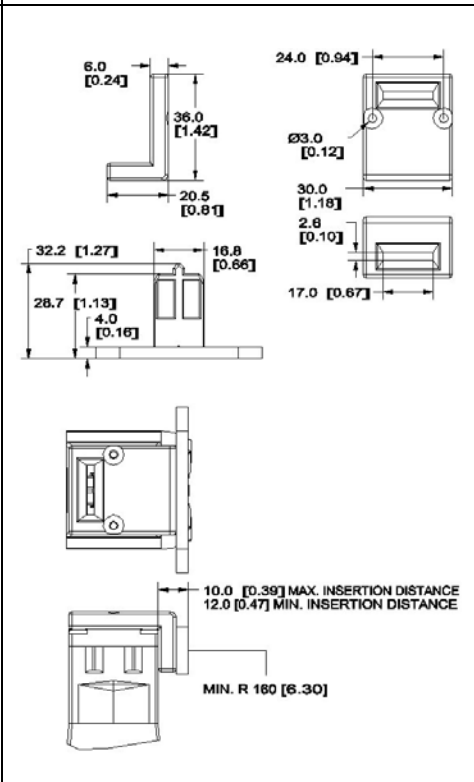
GKZS6	GKZS7	GKZS8
 <p>2.0 [0.08] 5.9 [0.23]</p> <p>22.00 [0.9] 75.2 [2.96] 41.7 [1.64] 20.0 [0.79] 15.0 [0.69] 18.7 [0.74] 3.0 [0.12] Ø5.0 [0.20]</p> <p>MIN. R160 [6.30]</p> <p>23.0 [0.9] MAX. INSERTION DISTANCE 25.5 [1.00] MIN. INSERTION DISTANCE</p>	 <p>16.0 [0.63] 2.0 [0.08] 4.0 [0.16] 16.8 [0.66] 56.0 [2.20] 40.0 [1.57] 22.7 [0.89] 26.2 [1.03]</p> <p>MIN. R 160 [6.30]</p> <p>4.0 [0.16] MAX. INSERTION DISTANCE 6.0 [0.24] MIN. INSERTION DISTANCE</p>	 <p>Ø5.5 [0.22] 40.0 [1.57] 26.0 [1.02] 19.0 [0.75] 2.0 [0.08] 16.8 [0.66] 19.0 [0.75] 2.0 [0.08] 50.0 [1.97]</p> <p>Recommend to apply glue after key set-up (LOCTITE 609)</p> <p>21.0 [0.83] MAX. INSERTION DISTANCE 29.5 [0.89] MIN. INSERTION DISTANCE</p> <p>MIN. R 32 [1.26]</p>
GKZS4	GKZS9	GKZSF
 <p>Ø5.5 [0.22] 50.0 [1.97] 40.0 [1.57] 20.0 [0.79]</p> <p>2.0 [0.08] 16.8 [0.66] 19.0 [0.75] 2.0 [0.08]</p> <p>Recommend to apply glue after key set-up (LOCTITE 609)</p> <p>21.0 [0.83] MAX. INSERTION DISTANCE 23.5 [0.93] MIN. INSERTION DISTANCE</p> <p>MIN. R 45 [7.77]</p>	 <p>Ø5.5 [0.22] 56.0 [2.20] 40.0 [1.57] 20.0 [0.79]</p> <p>2.0 [0.08] 16.8 [0.66] 18.0 [0.71] 12.0 [0.47] 4.0 [0.16]</p> <p>MOVABLE MAX.18°</p> <p>MOVABLE MAX.18°</p> <p>20.0 [0.79] MAX. INSERTION DISTANCE 22.0 [0.87] MIN. INSERTION DISTANCE</p>	 <p>6.0 [0.24] 24.0 [0.94] 36.0 [1.42] 20.5 [0.81] Ø3.0 [0.12] 30.0 [1.18] 2.8 [0.10] 17.0 [0.67]</p> <p>32.2 [1.27] 18.8 [0.66] 28.7 [1.13] 4.0 [0.16]</p> <p>10.0 [0.39] MAX. INSERTION DISTANCE 12.0 [0.47] MIN. INSERTION DISTANCE</p> <p>MIN. R 160 [6.30]</p>

## **WARNING**

### **PERSONAL INJURY**

DO NOT USE these products as safety or emergency stop devices or in any other application where failure of the product could result in personal injury.

**Failure to comply with these instructions could result in death or serious injury.**

### **WARRANTY/REMEDY**

Honeywell warrants goods of its manufacture as being free of defective materials and faulty workmanship. Honeywell's standard product warranty applies unless agreed to otherwise by Honeywell in writing; please refer to your order acknowledgement or consult your local sales office for specific warranty details. If warranted goods are returned to Honeywell during the period of coverage, Honeywell will repair or replace, at its option, without charge those items it finds defective. **The foregoing is buyer's sole remedy and is in lieu of all other warranties, expressed or implied, including those of merchantability and fitness for a particular purpose. In no event shall Honeywell be liable for consequential, special, or indirect damages.**

While we provide application assistance personally, through our literature and the Honeywell web site, it is up to the customer to determine the suitability of the product in the application.

Specifications may change without notice. The information we supply is believed to be accurate and reliable as of this printing. However, we assume no responsibility for its use.

## **WARNING**

### **MISUSE OF DOCUMENTATION**

- The information presented in this product sheet is for reference only. Do not use this document as a product installation guide.
- Complete installation, operation, and maintenance information is provided in the instructions supplied with each product.

**Failure to comply with these instructions could result in death or serious injury.**

### **SALES AND SERVICE**

Honeywell serves its customers through a worldwide network of sales offices, representatives and distributors. For application assistance, current specifications, pricing or name of the nearest Authorized Distributor, contact your local sales office or:

**E-mail:** [info.sc@honeywell.com](mailto:info.sc@honeywell.com)

**Internet:** [www.honeywell.com/sensing](http://www.honeywell.com/sensing)

#### **Phone and Fax:**

Asia Pacific	+65 6355-2828
	+65 6445-3033 Fax
Europe	+44 (0) 1698 481481
	+44 (0) 1698 481676 Fax
Latin America	+1-305-805-8188
	+1-305-883-8257 Fax
USA/Canada	+1-800-537-6945
	+1-815-235-6847
	+1-815-235-6545 Fax

### **Automation and Control Solutions**

Sensing and Control

Honeywell

1985 Douglas Drive North

Golden Valley, MN 55422

[www.honeywell.com/sensing](http://www.honeywell.com/sensing)

004743-1-EN IL50 GLO Printed in USA  
November 2006  
© 2006 Honeywell International Inc. All rights reserved.

# **Honeywell**