

Features

- High Performance, Low Power AVR[®] 8-Bit Microcontroller
- Advanced RISC Architecture
 - 120 Powerful Instructions – Most Single Clock Cycle Execution
 - 32 x 8 General Purpose Working Registers
 - Fully Static Operation
 - Up to 20 MIPS Throughput at 20 MHz
- High Endurance Non-volatile Memory segments
 - 1K Bytes of In-System Self-programmable Flash program memory
 - 64 Bytes EEPROM
 - 64 Bytes Internal SRAM
 - Write/Erase Cycles: 10,000 Flash/100,000 EEPROM
 - Data retention: 20 Years at 85°C/100 Years at 25°C (see [page 6](#))
 - Programming Lock for Self-Programming Flash & EEPROM Data Security
- Peripheral Features
 - One 8-bit Timer/Counter with Prescaler and Two PWM Channels
 - 4-channel, 10-bit ADC with Internal Voltage Reference
 - Programmable Watchdog Timer with Separate On-chip Oscillator
 - On-chip Analog Comparator
- Special Microcontroller Features
 - debugWIRE On-chip Debug System
 - In-System Programmable via SPI Port
 - External and Internal Interrupt Sources
 - Low Power Idle, ADC Noise Reduction, and Power-down Modes
 - Enhanced Power-on Reset Circuit
 - Programmable Brown-out Detection Circuit with Software Disable Function
 - Internal Calibrated Oscillator
- I/O and Packages
 - 8-pin PDIP/SOIC: Six Programmable I/O Lines
 - 10-pad MLF: Six Programmable I/O Lines
 - 20-pad MLF: Six Programmable I/O Lines
- Operating Voltage:
 - 1.8 – 5.5V
- Speed Grade:
 - 0 – 4 MHz @ 1.8 – 5.5V
 - 0 – 10 MHz @ 2.7 – 5.5V
 - 0 – 20 MHz @ 4.5 – 5.5V
- Industrial Temperature Range
- Low Power Consumption
 - Active Mode:
 - 190 µA at 1.8 V and 1 MHz
 - Idle Mode:
 - 24 µA at 1.8 V and 1 MHz



8-bit AVR[®] Microcontroller with 1K Bytes In-System Programmable Flash

ATtiny13A

Summary



1. Pin Configurations

Figure 1-1. Pinout of ATtiny13A



NOTE: Bottom pad should be soldered to ground.
DNC: Do Not Connect



NOTE: Bottom pad should be soldered to ground.
DNC: Do Not Connect

1.1 Pin Description

1.1.1 VCC

Supply voltage.

1.1.2 GND

Ground.

1.1.3 Port B (PB5:PB0)

Port B is a 6-bit bi-directional I/O port with internal pull-up resistors (selected for each bit). The Port B output buffers have symmetrical drive characteristics with both high sink and source capability. As inputs, Port B pins that are externally pulled low will source current if the pull-up resistors are activated. The Port B pins are tri-stated when a reset condition becomes active, even if the clock is not running.

Port B also serves the functions of various special features of the ATtiny13A as listed on [page 55](#).

1.1.4 RESET

Reset input. A low level on this pin for longer than the minimum pulse length will generate a reset, even if the clock is not running and provided the reset pin has not been disabled. The minimum pulse length is given in [Table 18-4 on page 120](#). Shorter pulses are not guaranteed to generate a reset.

The reset pin can also be used as a (weak) I/O pin.

2. Overview

The ATtiny13A is a low-power CMOS 8-bit microcontroller based on the AVR enhanced RISC architecture. By executing powerful instructions in a single clock cycle, the ATtiny13A achieves throughputs approaching 1 MIPS per MHz allowing the system designer to optimize power consumption versus processing speed.

2.1 Block Diagram

Figure 2-1. Block Diagram

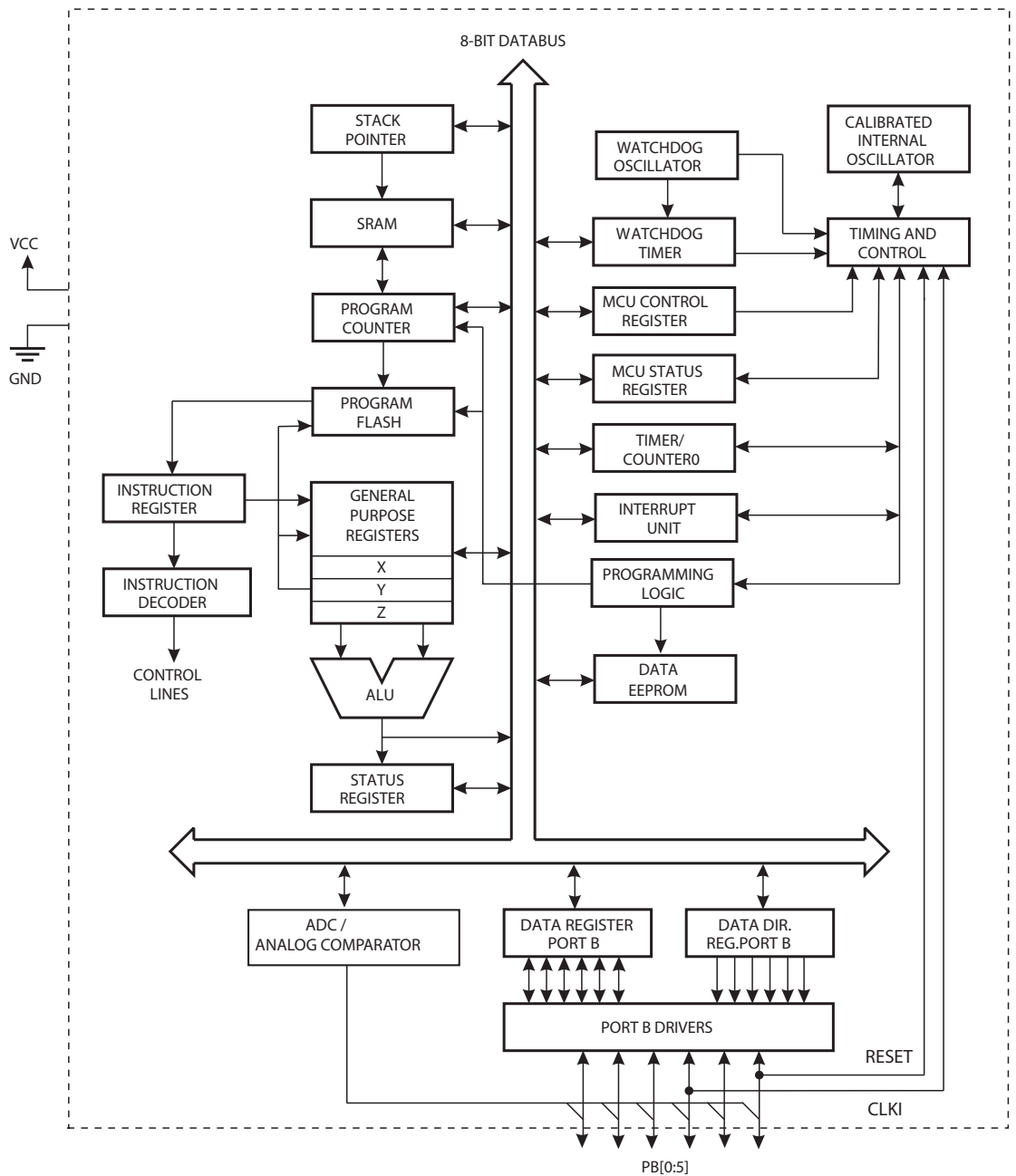

The AVR core combines a rich instruction set with 32 general purpose working registers. All 32 registers are directly connected to the Arithmetic Logic Unit (ALU), allowing two independent registers to be accessed in one single instruction executed in one clock cycle. The resulting architecture is more code efficient while achieving throughputs up to ten times faster than conventional CISC microcontrollers.

The ATtiny13A provides the following features: 1K byte of In-System Programmable Flash, 64 bytes EEPROM, 64 bytes SRAM, 6 general purpose I/O lines, 32 general purpose working registers, one 8-bit Timer/Counter with compare modes, Internal and External Interrupts, a 4-channel, 10-bit ADC, a programmable Watchdog Timer with internal Oscillator, and three software selectable power saving modes. The Idle mode stops the CPU while allowing the SRAM, Timer/Counter, ADC, Analog Comparator, and Interrupt system to continue functioning. The Power-down mode saves the register contents, disabling all chip functions until the next Interrupt or Hardware Reset. The ADC Noise Reduction mode stops the CPU and all I/O modules except ADC, to minimize switching noise during ADC conversions.

The device is manufactured using Atmel's high density non-volatile memory technology. The On-chip ISP Flash allows the Program memory to be re-programmed In-System through an SPI serial interface, by a conventional non-volatile memory programmer or by an On-chip boot code running on the AVR core.

The ATtiny13A AVR is supported with a full suite of program and system development tools including: C Compilers, Macro Assemblers, Program Debugger/Simulators, and Evaluation kits.

3. About

3.1 Resources

A comprehensive set of drivers, application notes, data sheets and descriptions on development tools are available for download at <http://www.atmel.com/avr>.

3.2 Code Examples

This documentation contains simple code examples that briefly show how to use various parts of the device. These code examples assume that the part specific header file is included before compilation. Be aware that not all C compiler vendors include bit definitions in the header files and interrupt handling in C is compiler dependent. Please confirm with the C compiler documentation for more details.

3.3 Data Retention

Reliability Qualification results show that the projected data retention failure rate is much less than 1 PPM over 20 years at 85°C or 100 years at 25°C.

4. Register Summary

Address	Name	Bit 7	Bit 6	Bit 5	Bit 4	Bit 3	Bit 2	Bit 1	Bit 0	Page
0x3F	SREG	I	T	H	S	V	N	Z	C	page 9
0x3E	Reserved	–	–	–	–	–	–	–	–	
0x3D	SPL	SPI[7:0]								page 11
0x3C	Reserved	–	–	–	–	–	–	–	–	
0x3B	GIMSK	–	INT0	PCIE	–	–	–	–	–	page 47
0x3A	GIFR	–	INTF0	PCIF	–	–	–	–	–	page 48
0x39	TIMSK0	–	–	–	–	OCIE0B	OCIE0A	TOIE0	–	page 75
0x38	TIFR0	–	–	–	–	OCF0B	OCF0A	TOV0	–	page 76
0x37	SPMCSR	–	–	–	CTPB	RFLB	PGWRT	PGERS	SELFPR-	page 98
0x36	OCR0A	Timer/Counter – Output Compare Register A								page 75
0x35	MCUCR	–	PUD	SE	SM1	SM0	–	ISC01	ISC00	pages 33, 47, 57
0x34	MCUSR	–	–	–	–	WDRF	BORF	EXTRF	PORF	page 42
0x33	TCCR0B	FOC0A	FOC0B	–	–	WGM02	CS02	CS01	CS00	page 73
0x32	TCNT0	Timer/Counter (8-bit)								page 74
0x31	OSCCAL	Oscillator Calibration Register								page 27
0x30	BODCR	–	–	–	–	–	–	BODS	BODSE	page 33
0x2F	TCCR0A	COM0A1	COM0A0	COM0B1	COM0B0	–	–	WGM01	WGM00	page 70
0x2E	DWDR	DWDR[7:0]								page 97
0x2D	Reserved	–								
0x2C	Reserved	–								
0x2B	Reserved	–								
0x2A	Reserved	–								
0x29	OCR0B	Timer/Counter – Output Compare Register B								page 75
0x28	GTCCR	TSM	–	–	–	–	–	–	PSR10	page 78
0x27	Reserved	–								
0x26	CLKPR	CLKPCE	–	–	–	CLKPS3	CLKPS2	CLKPS1	CLKPS0	page 28
0x25	PRR	–	–	–	–	–	–	PRTIM0	PRADC	page 34
0x24	Reserved	–								
0x23	Reserved	–								
0x22	Reserved	–								
0x21	WDTCR	WDTIF	WDTIE	WDP3	WDCE	WDE	WDP2	WDP1	WDP0	page 42
0x20	Reserved	–								
0x1F	Reserved	–								
0x1E	EEARL	–	–	EEPROM Address Register						page 20
0x1D	EEDR	EEPROM Data Register								page 20
0x1C	EECR	–	–	EEP01	EEP00	EERIE	EEMPE	EEPE	EERE	page 21
0x1B	Reserved	–								
0x1A	Reserved	–								
0x19	Reserved	–								
0x18	PORTB	–	–	PORTB5	PORTB4	PORTB3	PORTB2	PORTB1	PORTB0	page 57
0x17	DDRB	–	–	DDB5	DDB4	DDB3	DDB2	DDB1	DDB0	page 57
0x16	PINB	–	–	PINB5	PINB4	PINB3	PINB2	PINB1	PINB0	page 58
0x15	PCMSK	–	–	PCINT5	PCINT4	PCINT3	PCINT2	PCINT1	PCINT0	page 48
0x14	DIDR0	–	–	ADC0D	ADC2D	ADC3D	ADC1D	AIN1D	AIN0D	pages 81, 95
0x13	Reserved	–								
0x12	Reserved	–								
0x11	Reserved	–								
0x10	Reserved	–								
0x0F	Reserved	–								
0x0E	Reserved	–								
0x0D	Reserved	–								
0x0C	Reserved	–								
0x0B	Reserved	–								
0x0A	Reserved	–								
0x09	Reserved	–								
0x08	ACSR	ACD	ACBG	ACO	ACI	ACIE	–	ACIS1	ACIS0	page 80
0x07	ADMUX	–	REFS0	ADLAR	–	–	–	MUX1	MUX0	page 92
0x06	ADCSRA	ADEN	ADSC	ADATE	ADIF	ADIE	ADPS2	ADPS1	ADPS0	page 93
0x05	ADCH	ADC Data Register High Byte								page 94
0x04	ADCL	ADC Data Register Low Byte								page 94
0x03	ADCSRB	–	ACME	–	–	–	ADTS2	ADTS1	ADTS0	pages 80, 95
0x02	Reserved	–								
0x01	Reserved	–								
0x00	Reserved	–								



- Notes:
1. For compatibility with future devices, reserved bits should be written to zero if accessed. Reserved I/O memory addresses should never be written.
 2. I/O Registers within the address range 0x00 - 0x1F are directly bit-accessible using the SBI and CBI instructions. In these registers, the value of single bits can be checked by using the SBIS and SBIC instructions. Some of the Status Flags are cleared by writing a logical one to them. Note that, unlike most other AVR's, the CBI and SBI instructions will only operate on the specified bit, and can therefore be used on registers containing such Status Flags. The CBI and SBI instructions work with registers 0x00 to 0x1F only.

5. Instruction Set Summary

Mnemonics	Operands	Description	Operation	Flags	#Clocks
ARITHMETIC AND LOGIC INSTRUCTIONS					
ADD	Rd, Rr	Add two Registers	$Rd \leftarrow Rd + Rr$	Z,C,N,V,H	1
ADC	Rd, Rr	Add with Carry two Registers	$Rd \leftarrow Rd + Rr + C$	Z,C,N,V,H	1
ADIW	Rd,K	Add Immediate to Word	$Rdh:Rdl \leftarrow Rdh:Rdl + K$	Z,C,N,V,S	2
SUB	Rd, Rr	Subtract two Registers	$Rd \leftarrow Rd - Rr$	Z,C,N,V,H	1
SUBI	Rd, K	Subtract Constant from Register	$Rd \leftarrow Rd - K$	Z,C,N,V,H	1
SBC	Rd, Rr	Subtract with Carry two Registers	$Rd \leftarrow Rd - Rr - C$	Z,C,N,V,H	1
SBCI	Rd, K	Subtract with Carry Constant from Reg.	$Rd \leftarrow Rd - K - C$	Z,C,N,V,H	1
SBIW	Rd,K	Subtract Immediate from Word	$Rdh:Rdl \leftarrow Rdh:Rdl - K$	Z,C,N,V,S	2
AND	Rd, Rr	Logical AND Registers	$Rd \leftarrow Rd \cdot Rr$	Z,N,V	1
ANDI	Rd, K	Logical AND Register and Constant	$Rd \leftarrow Rd \cdot K$	Z,N,V	1
OR	Rd, Rr	Logical OR Registers	$Rd \leftarrow Rd \vee Rr$	Z,N,V	1
ORI	Rd, K	Logical OR Register and Constant	$Rd \leftarrow Rd \vee K$	Z,N,V	1
EOR	Rd, Rr	Exclusive OR Registers	$Rd \leftarrow Rd \oplus Rr$	Z,N,V	1
COM	Rd	One's Complement	$Rd \leftarrow 0xFF - Rd$	Z,C,N,V	1
NEG	Rd	Two's Complement	$Rd \leftarrow 0x00 - Rd$	Z,C,N,V,H	1
SBR	Rd,K	Set Bit(s) in Register	$Rd \leftarrow Rd \vee K$	Z,N,V	1
CBR	Rd,K	Clear Bit(s) in Register	$Rd \leftarrow Rd \cdot (\sim K)$	Z,N,V	1
INC	Rd	Increment	$Rd \leftarrow Rd + 1$	Z,N,V	1
DEC	Rd	Decrement	$Rd \leftarrow Rd - 1$	Z,N,V	1
TST	Rd	Test for Zero or Minus	$Rd \leftarrow Rd \cdot Rd$	Z,N,V	1
CLR	Rd	Clear Register	$Rd \leftarrow Rd \oplus Rd$	Z,N,V	1
SER	Rd	Set Register	$Rd \leftarrow 0xFF$	None	1
BRANCH INSTRUCTIONS					
RJMP	k	Relative Jump	$PC \leftarrow PC + k + 1$	None	2
IJMP		Indirect Jump to (Z)	$PC \leftarrow Z$	None	2
RCALL	k	Relative Subroutine Call	$PC \leftarrow PC + k + 1$	None	3
ICALL		Indirect Call to (Z)	$PC \leftarrow Z$	None	3
RET		Subroutine Return	$PC \leftarrow STACK$	None	4
RETI		Interrupt Return	$PC \leftarrow STACK$	I	4
CPSE	Rd,Rr	Compare, Skip if Equal	if (Rd = Rr) $PC \leftarrow PC + 2$ or 3	None	1/2/3
CP	Rd,Rr	Compare	$Rd - Rr$	Z, N,V,C,H	1
CPC	Rd,Rr	Compare with Carry	$Rd - Rr - C$	Z, N,V,C,H	1
CPI	Rd,K	Compare Register with Immediate	$Rd - K$	Z, N,V,C,H	1
SBRC	Rr, b	Skip if Bit in Register Cleared	if (Rr(b)=0) $PC \leftarrow PC + 2$ or 3	None	1/2/3
SBRS	Rr, b	Skip if Bit in Register is Set	if (Rr(b)=1) $PC \leftarrow PC + 2$ or 3	None	1/2/3
SBIC	P, b	Skip if Bit in I/O Register Cleared	if (P(b)=0) $PC \leftarrow PC + 2$ or 3	None	1/2/3
SBIS	P, b	Skip if Bit in I/O Register is Set	if (P(b)=1) $PC \leftarrow PC + 2$ or 3	None	1/2/3
BRBS	s, k	Branch if Status Flag Set	if (SREG(s) = 1) then $PC \leftarrow PC + k + 1$	None	1/2
BRBC	s, k	Branch if Status Flag Cleared	if (SREG(s) = 0) then $PC \leftarrow PC + k + 1$	None	1/2
BRREQ	k	Branch if Equal	if (Z = 1) then $PC \leftarrow PC + k + 1$	None	1/2
BRNE	k	Branch if Not Equal	if (Z = 0) then $PC \leftarrow PC + k + 1$	None	1/2
BRCS	k	Branch if Carry Set	if (C = 1) then $PC \leftarrow PC + k + 1$	None	1/2
BRCC	k	Branch if Carry Cleared	if (C = 0) then $PC \leftarrow PC + k + 1$	None	1/2
BRSH	k	Branch if Same or Higher	if (C = 0) then $PC \leftarrow PC + k + 1$	None	1/2
BRLO	k	Branch if Lower	if (C = 1) then $PC \leftarrow PC + k + 1$	None	1/2
BRMI	k	Branch if Minus	if (N = 1) then $PC \leftarrow PC + k + 1$	None	1/2
BRPL	k	Branch if Plus	if (N = 0) then $PC \leftarrow PC + k + 1$	None	1/2
BRGE	k	Branch if Greater or Equal, Signed	if (N ⊕ V = 0) then $PC \leftarrow PC + k + 1$	None	1/2
BRLT	k	Branch if Less Than Zero, Signed	if (N ⊕ V = 1) then $PC \leftarrow PC + k + 1$	None	1/2
BRHS	k	Branch if Half Carry Flag Set	if (H = 1) then $PC \leftarrow PC + k + 1$	None	1/2
BRHC	k	Branch if Half Carry Flag Cleared	if (H = 0) then $PC \leftarrow PC + k + 1$	None	1/2
BRTS	k	Branch if T Flag Set	if (T = 1) then $PC \leftarrow PC + k + 1$	None	1/2
BRTC	k	Branch if T Flag Cleared	if (T = 0) then $PC \leftarrow PC + k + 1$	None	1/2
BRVS	k	Branch if Overflow Flag is Set	if (V = 1) then $PC \leftarrow PC + k + 1$	None	1/2
BRVC	k	Branch if Overflow Flag is Cleared	if (V = 0) then $PC \leftarrow PC + k + 1$	None	1/2
BRIE	k	Branch if Interrupt Enabled	if (I = 1) then $PC \leftarrow PC + k + 1$	None	1/2
BRID	k	Branch if Interrupt Disabled	if (I = 0) then $PC \leftarrow PC + k + 1$	None	1/2
BIT AND BIT-TEST INSTRUCTIONS					
SBI	P,b	Set Bit in I/O Register	$I/O(P,b) \leftarrow 1$	None	2
CBI	P,b	Clear Bit in I/O Register	$I/O(P,b) \leftarrow 0$	None	2
LSL	Rd	Logical Shift Left	$Rd(n+1) \leftarrow Rd(n), Rd(0) \leftarrow 0$	Z,C,N,V	1
LSR	Rd	Logical Shift Right	$Rd(n) \leftarrow Rd(n+1), Rd(7) \leftarrow 0$	Z,C,N,V	1
ROL	Rd	Rotate Left Through Carry	$Rd(0) \leftarrow C, Rd(n+1) \leftarrow Rd(n), C \leftarrow Rd(7)$	Z,C,N,V	1

Mnemonics	Operands	Description	Operation	Flags	#Clocks
ROR	Rd	Rotate Right Through Carry	$Rd(7) \leftarrow C, Rd(n) \leftarrow Rd(n+1), C \leftarrow Rd(0)$	Z,C,N,V	1
ASR	Rd	Arithmetic Shift Right	$Rd(n) \leftarrow Rd(n+1), n=0..6$	Z,C,N,V	1
SWAP	Rd	Swap Nibbles	$Rd(3..0) \leftarrow Rd(7..4), Rd(7..4) \leftarrow Rd(3..0)$	None	1
BSET	s	Flag Set	$SREG(s) \leftarrow 1$	SREG(s)	1
BCLR	s	Flag Clear	$SREG(s) \leftarrow 0$	SREG(s)	1
BST	Rr, b	Bit Store from Register to T	$T \leftarrow Rr(b)$	T	1
BLD	Rd, b	Bit load from T to Register	$Rd(b) \leftarrow T$	None	1
SEC		Set Carry	$C \leftarrow 1$	C	1
CLC		Clear Carry	$C \leftarrow 0$	C	1
SEN		Set Negative Flag	$N \leftarrow 1$	N	1
CLN		Clear Negative Flag	$N \leftarrow 0$	N	1
SEZ		Set Zero Flag	$Z \leftarrow 1$	Z	1
CLZ		Clear Zero Flag	$Z \leftarrow 0$	Z	1
SEI		Global Interrupt Enable	$I \leftarrow 1$	I	1
CLI		Global Interrupt Disable	$I \leftarrow 0$	I	1
SES		Set Signed Test Flag	$S \leftarrow 1$	S	1
CLS		Clear Signed Test Flag	$S \leftarrow 0$	S	1
SEV		Set Twos Complement Overflow	$V \leftarrow 1$	V	1
CLV		Clear Twos Complement Overflow	$V \leftarrow 0$	V	1
SET		Set T in SREG	$T \leftarrow 1$	T	1
CLT		Clear T in SREG	$T \leftarrow 0$	T	1
SEH		Set Half Carry Flag in SREG	$H \leftarrow 1$	H	1
CLH		Clear Half Carry Flag in SREG	$H \leftarrow 0$	H	1
DATA TRANSFER INSTRUCTIONS					
MOV	Rd, Rr	Move Between Registers	$Rd \leftarrow Rr$	None	1
MOVW	Rd, Rr	Copy Register Word	$Rd+1:Rd \leftarrow Rr+1:Rr$	None	1
LDI	Rd, K	Load Immediate	$Rd \leftarrow K$	None	1
LD	Rd, X	Load Indirect	$Rd \leftarrow (X)$	None	2
LD	Rd, X+	Load Indirect and Post-Inc.	$Rd \leftarrow (X), X \leftarrow X + 1$	None	2
LD	Rd, -X	Load Indirect and Pre-Dec.	$X \leftarrow X - 1, Rd \leftarrow (X)$	None	2
LD	Rd, Y	Load Indirect	$Rd \leftarrow (Y)$	None	2
LD	Rd, Y+	Load Indirect and Post-Inc.	$Rd \leftarrow (Y), Y \leftarrow Y + 1$	None	2
LD	Rd, -Y	Load Indirect and Pre-Dec.	$Y \leftarrow Y - 1, Rd \leftarrow (Y)$	None	2
LDD	Rd, Y+q	Load Indirect with Displacement	$Rd \leftarrow (Y + q)$	None	2
LD	Rd, Z	Load Indirect	$Rd \leftarrow (Z)$	None	2
LD	Rd, Z+	Load Indirect and Post-Inc.	$Rd \leftarrow (Z), Z \leftarrow Z + 1$	None	2
LD	Rd, -Z	Load Indirect and Pre-Dec.	$Z \leftarrow Z - 1, Rd \leftarrow (Z)$	None	2
LDD	Rd, Z+q	Load Indirect with Displacement	$Rd \leftarrow (Z + q)$	None	2
LDS	Rd, k	Load Direct from SRAM	$Rd \leftarrow (k)$	None	2
ST	X, Rr	Store Indirect	$(X) \leftarrow Rr$	None	2
ST	X+, Rr	Store Indirect and Post-Inc.	$(X) \leftarrow Rr, X \leftarrow X + 1$	None	2
ST	-X, Rr	Store Indirect and Pre-Dec.	$X \leftarrow X - 1, (X) \leftarrow Rr$	None	2
ST	Y, Rr	Store Indirect	$(Y) \leftarrow Rr$	None	2
ST	Y+, Rr	Store Indirect and Post-Inc.	$(Y) \leftarrow Rr, Y \leftarrow Y + 1$	None	2
ST	-Y, Rr	Store Indirect and Pre-Dec.	$Y \leftarrow Y - 1, (Y) \leftarrow Rr$	None	2
STD	Y+q, Rr	Store Indirect with Displacement	$(Y + q) \leftarrow Rr$	None	2
ST	Z, Rr	Store Indirect	$(Z) \leftarrow Rr$	None	2
ST	Z+, Rr	Store Indirect and Post-Inc.	$(Z) \leftarrow Rr, Z \leftarrow Z + 1$	None	2
ST	-Z, Rr	Store Indirect and Pre-Dec.	$Z \leftarrow Z - 1, (Z) \leftarrow Rr$	None	2
STD	Z+q, Rr	Store Indirect with Displacement	$(Z + q) \leftarrow Rr$	None	2
STS	k, Rr	Store Direct to SRAM	$(k) \leftarrow Rr$	None	2
LPM		Load Program Memory	$R0 \leftarrow (Z)$	None	3
LPM	Rd, Z	Load Program Memory	$Rd \leftarrow (Z)$	None	3
LPM	Rd, Z+	Load Program Memory and Post-Inc	$Rd \leftarrow (Z), Z \leftarrow Z + 1$	None	3
SPM		Store Program Memory	$(z) \leftarrow R1:R0$	None	
IN	Rd, P	In Port	$Rd \leftarrow P$	None	1
OUT	P, Rr	Out Port	$P \leftarrow Rr$	None	1
PUSH	Rr	Push Register on Stack	$STACK \leftarrow Rr$	None	2
POP	Rd	Pop Register from Stack	$Rd \leftarrow STACK$	None	2
MCU CONTROL INSTRUCTIONS					
NOP		No Operation		None	1
SLEEP		Sleep	(see specific descr. for Sleep function)	None	1
WDR		Watchdog Reset	(see specific descr. for WDR/Timer)	None	1
BREAK		Break	For On-chip Debug Only	None	N/A

6. Ordering Information

Speed (MHz)	Power Supply (V)	Ordering Code ⁽¹⁾	Package ⁽²⁾	Operation Range
20	1.8 - 5.5	ATtiny13A-PU	8P3	Industrial (-40°C to +85°C) ⁽⁴⁾
		ATtiny13A-SU	8S2	
		ATtiny13A-SUR	8S2	
		ATtiny13A-SH	8S2	
		ATtiny13A-SHR	8S2	
		ATtiny13A-SSU	8S1	
		ATtiny13A-SSUR	8S1	
		ATtiny13A-SSH	8S1	
		ATtiny13A-SSHR	8S1	
		ATtiny13A-MU	20M1	
		ATtiny13A-MUR	20M1	
		ATtiny13A-MMU ⁽³⁾	10M1 ⁽³⁾	
		ATtiny13A-MMUR ⁽³⁾	10M1 ⁽³⁾	
		ATtiny13A-SN	8S2	Industrial (-40°C to +105°C) ⁽⁵⁾
		ATtiny13A-SNR	8S2	
ATtiny13A-SS7	8S1			
ATtiny13A-SS7R	8S1			
ATtiny13A-SF	8S2	Industrial (-40°C to +125°C) ⁽⁶⁾		
ATtiny13A-SFR	8S2			
ATtiny13A-MMF	10M1 ⁽³⁾			
ATtiny13A-MMFR	10M1 ⁽³⁾			

Notes: 1. Code indicators:

- H or 7: NiPdAu lead finish
- U, N or F: matte tin
- R: tape & reel

2. All packages are Pb-free, halide-free and fully green and they comply with the European directive for Restriction of Hazardous Substances (RoHS).

3. Topside marking for ATtiny13A:

- 1st Line: T13
- 2nd Line: Axx
- 3rd Line: xxx

4. These devices can also be supplied in wafer form. Please contact your local Atmel sales office for detailed ordering information and minimum quantities.

5. For typical and Electrical characteristics for this device please consult Appendix A, ATtiny13A Specification at 105°C.

6. For typical and Electrical characteristics for this device please consult Appendix B, ATtiny13A Specification at 125°C.

Package Type	
8P3	8-lead, 0.300" Wide, Plastic Dual Inline Package (PDIP)
8S2	8-lead, 0.209" Wide, Plastic Small Outline Package (EIAJ SOIC)
8S1	8-lead, 0.150" Wide, Plastic Gull-Wing Small Outline (JEDEC SOIC)
20M1	20-pad, 4 x 4 x 0.8 mm Body, Lead Pitch 0.50 mm, Micro Lead Frame Package (MLF)
10M1	10-pad, 3 x 3 x 1 mm Body, Lead Pitch 0.50 mm, Micro Lead Frame Package (MLF)

7. Packaging Information

7.1 8P3

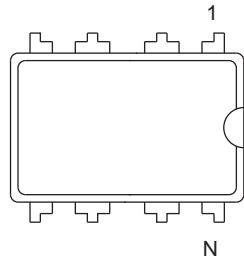

Top View

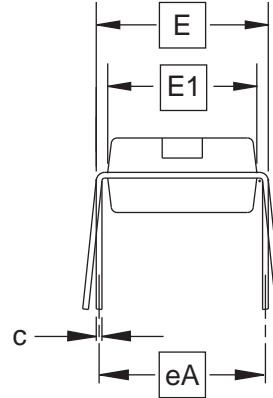

End View

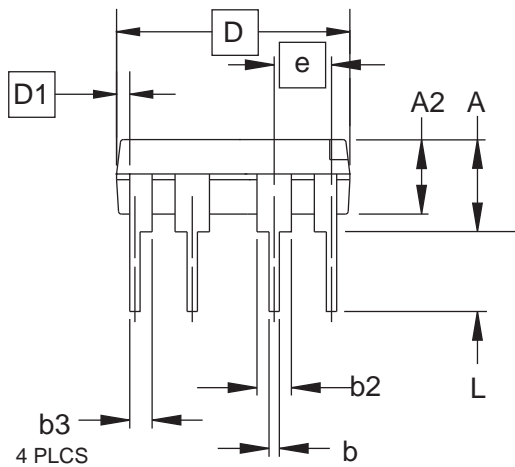

Side View

COMMON DIMENSIONS
(Unit of Measure = inches)

SYMBOL	MIN	NOM	MAX	NOTE
A			0.210	2
A2	0.115	0.130	0.195	
b	0.014	0.018	0.022	5
b2	0.045	0.060	0.070	6
b3	0.030	0.039	0.045	6
c	0.008	0.010	0.014	
D	0.355	0.365	0.400	3
D1	0.005			3
E	0.300	0.310	0.325	4
E1	0.240	0.250	0.280	3
e	0.100 BSC			
eA	0.300 BSC			4
L	0.115	0.130	0.150	2

- Notes:
1. This drawing is for general information only; refer to JEDEC Drawing MS-001, Variation BA for additional information.
 2. Dimensions A and L are measured with the package seated in JEDEC seating plane Gauge GS-3.
 3. D, D1 and E1 dimensions do not include mold Flash or protrusions. Mold Flash or protrusions shall not exceed 0.010 inch.
 4. E and eA measured with the leads constrained to be perpendicular to datum.
 5. Pointed or rounded lead tips are preferred to ease insertion.
 6. b2 and b3 maximum dimensions do not include Dambar protrusions. Dambar protrusions shall not exceed 0.010 (0.25 mm).

01/09/02



2325 Orchard Parkway
San Jose, CA 95131

TITLE
8P3, 8-lead, 0.300" Wide Body, Plastic Dual
In-line Package (PDIP)

DRAWING NO.
8P3

REV.
B

7.2 8S2

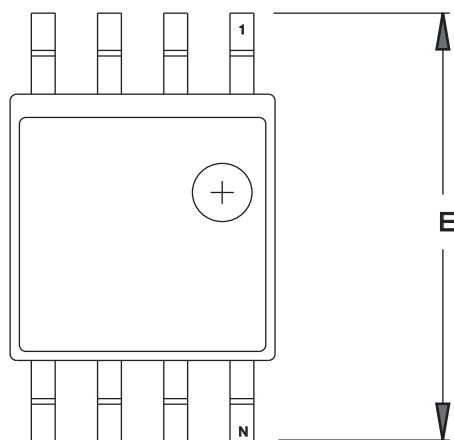

TOP VIEW

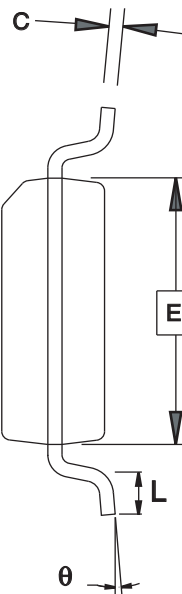

END VIEW

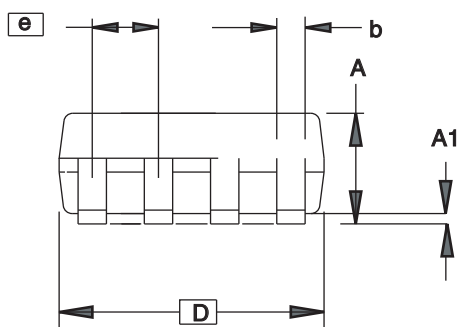

SIDE VIEW

COMMON DIMENSIONS
(Unit of Measure = mm)

SYMBOL	MIN	NOM	MAX	NOTE
A	1.70		2.16	
A1	0.05		0.25	
b	0.35		0.48	4
C	0.15		0.35	4
D	5.13		5.35	
E1	5.18		5.40	2
E	7.70		8.26	
L	0.51		0.85	
θ	0°		8°	
e	1.27 BSC			3

- Notes: 1. This drawing is for general information only; refer to EIAJ Drawing EDR-7320 for additional information.
 2. Mismatch of the upper and lower dies and resin burrs aren't included.
 3. Determines the true geometric position.
 4. Values b,C apply to plated terminal. The standard thickness of the plating layer shall measure between 0.007 to .021 mm.

4/15/08



Package Drawing Contact:
packagedrawings@atmel.com

TITLE
8S2, 8-lead, 0.208" Body, Plastic Small
Outline Package (EIAJ)

GPC
STN

DRAWING NO.
8S2

REV.
F



7.3 8S1

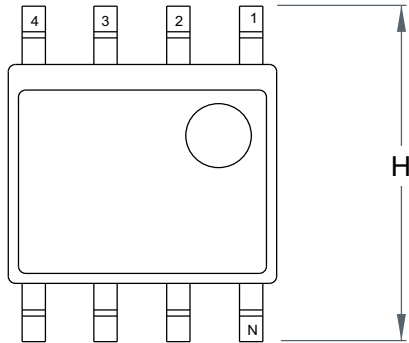

Top View

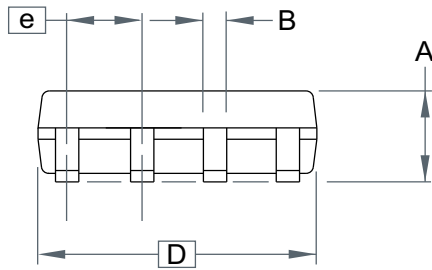

Side View

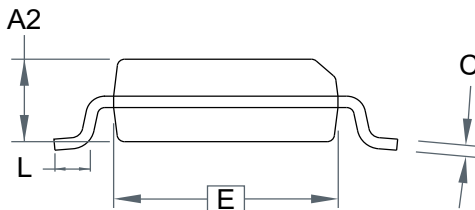

End View

COMMON DIMENSIONS
(Unit of Measure = mm)

SYMBOL	MIN	NOM	MAX	NOTE
A	-	-	1.75	
B	-	-	0.51	
C	-	-	0.25	
D	-	-	5.00	
E	-	-	4.00	
e	1.27 BSC			
H	-	-	6.20	
L	-	-	1.27	

Note: This drawing is for general information only. Refer to JEDEC Drawing MS-012 for proper dimensions, tolerances, datums, etc.

2010-10-20



2325 Orchard Parkway
San Jose, CA 95131

TITLE
8S1, 8-lead (0.150" Wide Body), Plastic Gull Wing
Small Outline (JEDEC SOIC)

DRAWING NO.
8S1

REV.
B

7.4 20M1

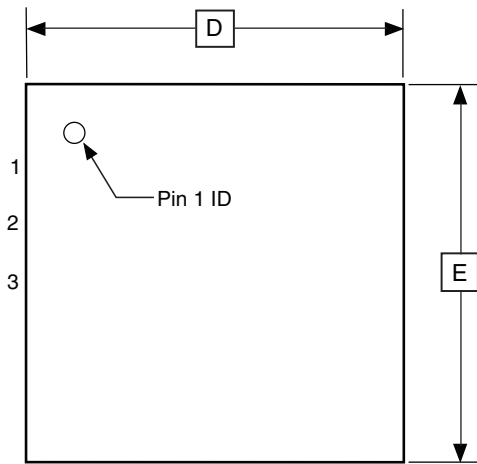

TOP VIEW

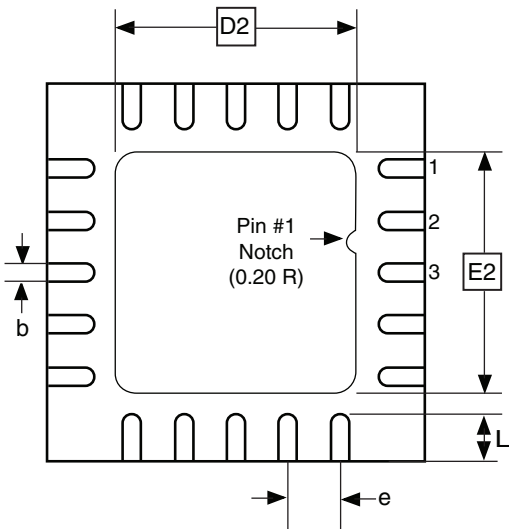

BOTTOM VIEW

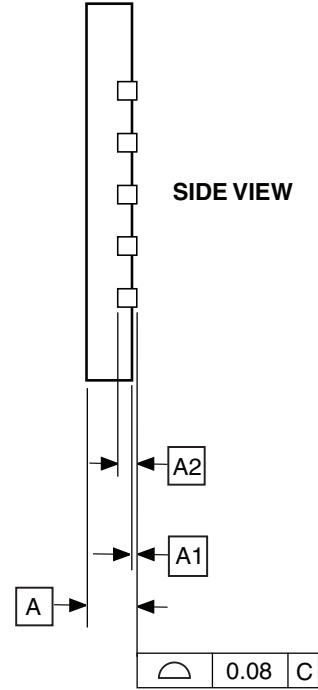

COMMON DIMENSIONS
(Unit of Measure = mm)

SYMBOL	MIN	NOM	MAX	NOTE
A	0.70	0.75	0.80	
A1	-	0.01	0.05	
A2	0.20 REF			
b	0.18	0.23	0.30	
D	4.00 BSC			
D2	2.45	2.60	2.75	
E	4.00 BSC			
E2	2.45	2.60	2.75	
e	0.50 BSC			
L	0.35	0.40	0.55	

Note: Reference JEDEC Standard MO-220, Fig.1 (SAW Singulation) WGGD-5.

10/27/04



2325 Orchard Parkway
San Jose, CA 95131

TITLE

20M1, 20-pad, 4 x 4 x 0.8 mm Body, Lead Pitch 0.50 mm,
2.6 mm Exposed Pad, Micro Lead Frame Package (MLF)

DRAWING NO.

20M1

REV.

B



7.5 10M1

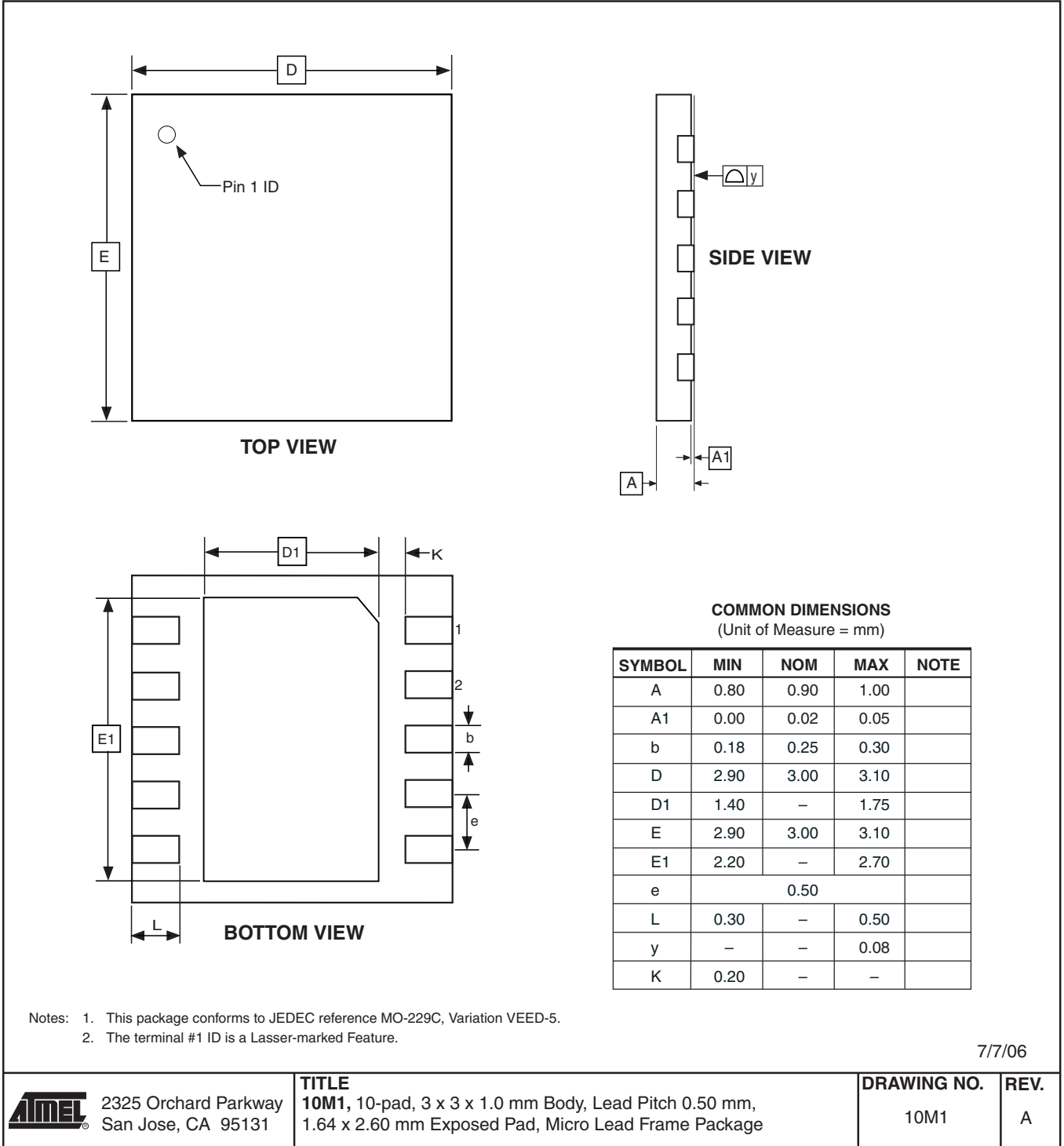

8. Errata

The revision letters in this section refer to the revision of the ATtiny13A device.

8.1 ATtiny13A Rev. G – H

- **EEPROM can not be written below 1.9 Volt**

1. **EEPROM can not be written below 1.9 Volt**

Writing the EEPROM at V_{CC} below 1.9 volts might fail.

Problem Fix/Workaround

Do not write the EEPROM when V_{CC} is below 1.9 volts.

8.2 ATtiny13A Rev. E – F

These device revisions were not sampled.

8.3 ATtiny13 Rev. A – D

These device revisions were referred to as ATtiny13/ATtiny13V.

9. Datasheet Revision History

Please note that page numbers in this section refer to the current version of this document and may not apply to previous versions.

9.1 Rev. 8126F – 05/12

1. Updated [Table 10-5 on page 57](#).
2. Updated order codes on [page 11](#).

9.2 Rev. 8126E – 07/10

1. Updated description in [Section 6.4.2 “CLKPR – Clock Prescale Register” on page 28](#).
2. Adjusted notes in [Table 18-1, “DC Characteristics, TA = -40°C to +85°C,” on page 117](#).
3. Updated plot order in [Section 19. “Typical Characteristics” on page 124](#), added some plots, also some headers and figure titles adjusted.
4. Updated [Section 6. “Ordering Information” on page 11](#), added extended temperature part numbers, as well tape & reel part numbers. Notes adjusted.
5. Updated bit syntax throughout the datasheet, e.g. from CS02:0 to CS0[2:0].

9.3 Rev. 8126D – 11/09

1. Added note “If the RSTDISPL fuse is programmed...” in Startup-up Times [Table 6-5](#) and [Table 6-6 on page 26](#).
2. Added addresses in all Register Description tables and cross-references to Register Summary.
3. Updated naming convention for -COM bits in tables from [Table 11-2 on page 70](#) to [Table 11-7 on page 72](#).
4. Updated value for t_{WD_ERASE} in [Table 17-8, “Minimum Wait Delay Before Writing the Next Flash or EEPROM Location,” on page 108](#).
5. Added NiPdAU note for -SH and -SSH in [Section 6. “Ordering Information” on page 11](#).

9.4 Rev. 8126C – 09/09

1. Added EEPROM errata for rev. G - H on [page 17](#).
2. Added a note about topside marking in [Section 6. “Ordering Information” on page 11](#).

9.5 Rev. 8126B – 11/08

1. Updated order codes on [page 11](#) to reflect changes in material composition.
2. Updated sections:
 - [“DIDR0 – Digital Input Disable Register 0” on page 81](#)
 - [“DIDR0 – Digital Input Disable Register 0” on page 95](#)
3. Updated [“Register Summary” on page 7](#).

9.6 Rev. 8126A – 05/08

1. Initial revision, created from document 2535I – 04/08.
2. Updated characteristic plots of section [“Typical Characteristics”](#), starting on page [124](#).
3. Updated [“Ordering Information” on page 11](#).
4. Updated section:
 - [“Speed” on page 118](#)

5. Update tables:
 - “DC Characteristics, TA = -40°C to +85°C” on page 117
 - “Calibration Accuracy of Internal RC Oscillator” on page 119
 - “Reset, Brown-out, and Internal Voltage Characteristics” on page 120
 - “ADC Characteristics, Single Ended Channels. TA = -40°C to +85°C” on page 121
 - “Serial Programming Characteristics, TA = -40°C to +85°C” on page 122
6. Added description of new function, “Power Reduction Register”:
 - Added functional description on [page 31](#)
 - Added bit description on [page 34](#)
 - Added section “Supply Current of I/O Modules” on page 124
 - Updated Register Summary on [page 7](#)
7. Added description of new function, “Software BOD Disable”:
 - Added functional description on [page 31](#)
 - Updated section on [page 32](#)
 - Added register description on [page 33](#)
 - Updated Register Summary on [page 7](#)
8. Added description of enhanced function, “Enhanced Power-On Reset”:
 - Updated [Table 18-4 on page 120](#), and [Table 18-5 on page 120](#)



Headquarters

Atmel Corporation

2325 Orchard Parkway
San Jose, CA 95131
USA
Tel: (+1)(408) 441-0311
Fax: (+1)(408) 487-2600

International

Atmel Asia Limited

Unit 01-5 & 16, 19F
BEA Tower, Millennium City 5
418 Kwun Tong Road
Kwun Tong, Kowloon
HONG KONG
Tel: (+852) 2245-6100
Fax: (+852) 2722-1369

Atmel Munich GmbH

Business Campus
Parking 4
D-85748 Garching b. Munich
GERMANY
Tel: (+49) 89-31970-0
Fax: (+49) 89-3194621

Atmel Japan

9F, Tonetsu Shinkawa Bldg.
1-24-8 Shinkawa
Chuo-ku, Tokyo 104-0033
JAPAN
Tel: (+81)(3) 3523-3551
Fax: (+81)(3) 3523-7581

Product Contact

Web Site

www.atmel.com

Technical Support

avr@atmel.com

Sales Contact

www.atmel.com/contacts

Literature Requests

www.atmel.com/literature

Disclaimer: The information in this document is provided in connection with Atmel products. No license, express or implied, by estoppel or otherwise, to any intellectual property right is granted by this document or in connection with the sale of Atmel products. **EXCEPT AS SET FORTH IN ATMEL'S TERMS AND CONDITIONS OF SALE LOCATED ON ATMEL'S WEB SITE, ATMEL ASSUMES NO LIABILITY WHATSOEVER AND DISCLAIMS ANY EXPRESS, IMPLIED OR STATUTORY WARRANTY RELATING TO ITS PRODUCTS INCLUDING, BUT NOT LIMITED TO, THE IMPLIED WARRANTY OF MERCHANTABILITY, FITNESS FOR A PARTICULAR PURPOSE, OR NON-INFRINGEMENT. IN NO EVENT SHALL ATMEL BE LIABLE FOR ANY DIRECT, INDIRECT, CONSEQUENTIAL, PUNITIVE, SPECIAL OR INCIDENTAL DAMAGES (INCLUDING, WITHOUT LIMITATION, DAMAGES FOR LOSS OF PROFITS, BUSINESS INTERRUPTION, OR LOSS OF INFORMATION) ARISING OUT OF THE USE OR INABILITY TO USE THIS DOCUMENT, EVEN IF ATMEL HAS BEEN ADVISED OF THE POSSIBILITY OF SUCH DAMAGES.** Atmel makes no representations or warranties with respect to the accuracy or completeness of the contents of this document and reserves the right to make changes to specifications and product descriptions at any time without notice. Atmel does not make any commitment to update the information contained herein. Unless specifically provided otherwise, Atmel products are not suitable for, and shall not be used in, automotive applications. Atmel's products are not intended, authorized, or warranted for use as components in applications intended to support or sustain life.

© 2012 Atmel Corporation. All rights reserved.

Atmel®, logo and combinations thereof, and others are registered trademarks or trademarks of Atmel Corporation or its subsidiaries. Other terms and product names may be trademarks of others.