

# Panasonic

## DB2G32600L1

For rectification

### ■ Features

- Low forward voltage VF
- Forward current (Average) IF(AV) ≤ 1.0 A rectification is possible
- RoHS compliant  
(EU RoHS / MSL:Level 1 compliant)

### ■ Marking Symbol: A4

### ■ Packaging

Embossed type (Thermo-compression sealing) : 1 000 pcs / reel (standard)

### ■ Absolute Maximum Ratings

Parameter	Symbol	Min	Max	Unit
Reverse Voltage <sup>*1</sup>	VR	-	30	V
Maximum Peak Reverse Voltage <sup>*1</sup>	VRM	-	30	V
Average Forward Current <sup>*2,3</sup>	IF(AV)	-	1.0	A
Average Forward Current <sup>*2,4</sup>	IF(AV)	-	1.0	A
Non-repetitive Peak Surge Forward Current <sup>*1,5</sup>	IFSM	-	15	A
Operating Junction Temperature <sup>*6</sup>	Tj	-	150	°C
Ambient Temperature	Ta	-40	+150	°C
Storage Temperature	Tstg	-55	+150	°C

Note) \*1: Ta = Tj = 25°C

\*2: Squire wave : σ = 0.5

\*3: Ta ≤ 102°C, when device mounted on a FR4 PCB (25.4mm×25.4mm, 1mm thick), copper wiring (620.0mm<sup>2</sup> area, 36μm thick).

\*4: Tsp ≤ 139°C

\*5: Squire wave : Tp = 5 ms

\*6: Power derating is necessary so that Tj < 150°C.

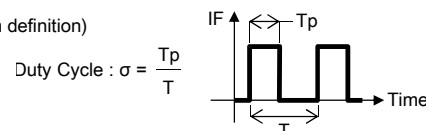
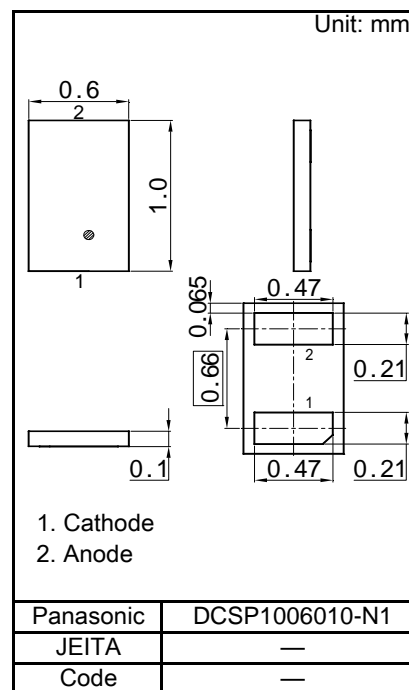

### ■ Electrical Characteristics Ta = 25 °C ± 3 °C

Parameter	Symbol	Conditions	Min	Typ	Max	Unit
Forward Voltage	VF	IF = 1.0 A	-	0.35	0.44	V
Reverse Current	IR	VR = 30 V	-	200	900	μA
Terminal Capacitance	Ct	VR = 10 V, f = 1 MHz	-	32	-	pF
Reverse Recovery Time <sup>*1</sup>	trr	IF = IR = 100 mA, Irr = 10 mA	-	10	-	ns

Note) 1. Measuring methods are based on JAPANESE INDUSTRIAL STANDARD JIS C 7031 measuring methods for diodes.

2. This product is sensitive to electric shock (static electricity, etc.).

Due attention must be paid on the charge of a human body and the leakage of current from the operating equipment.

3. \*1: Measurement circuit, input pulse, output pulse for Reverse recovery time

(Measurement circuit)

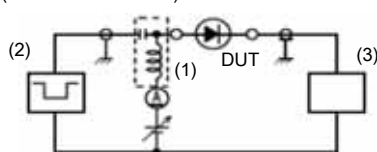

- (1) Bias Insertion Unit (N-50BU)
- (2) Pulse Generator (PG-10N), RS = 50 Ω
- (3) Wave Form Analyzer (SAS-8130), Ri = 50 Ω

(Input pulse)

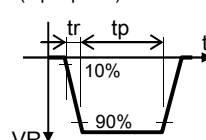

- tp = 2 μs  
tr = 0.35 ns  
σ = 0.05

(Output pulse)

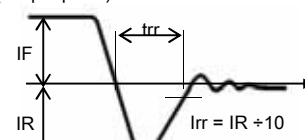

- IF = 100 mA  
IR = 100 mA  
Irr = 10 mA



Electrical Characteristics Technical Data (Reference)

IF - VF / Typical Data

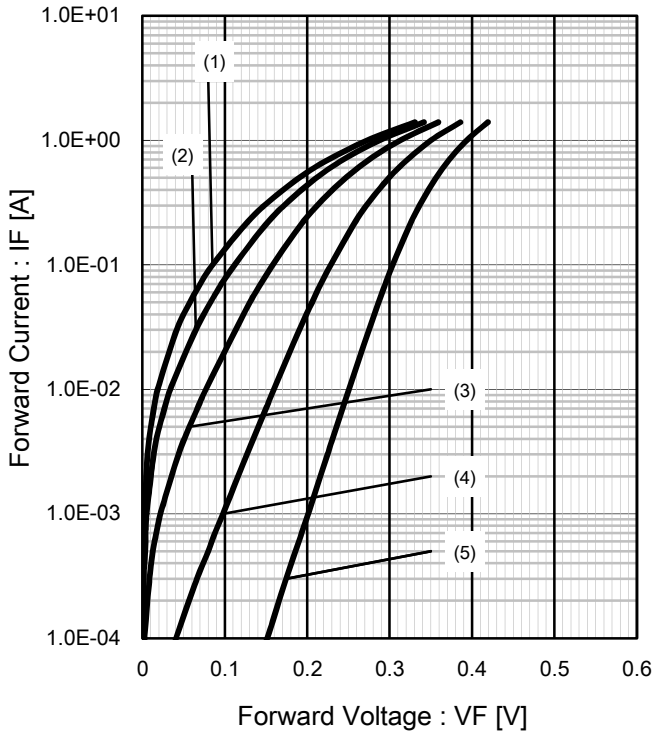

Ct - VR / Typical Data

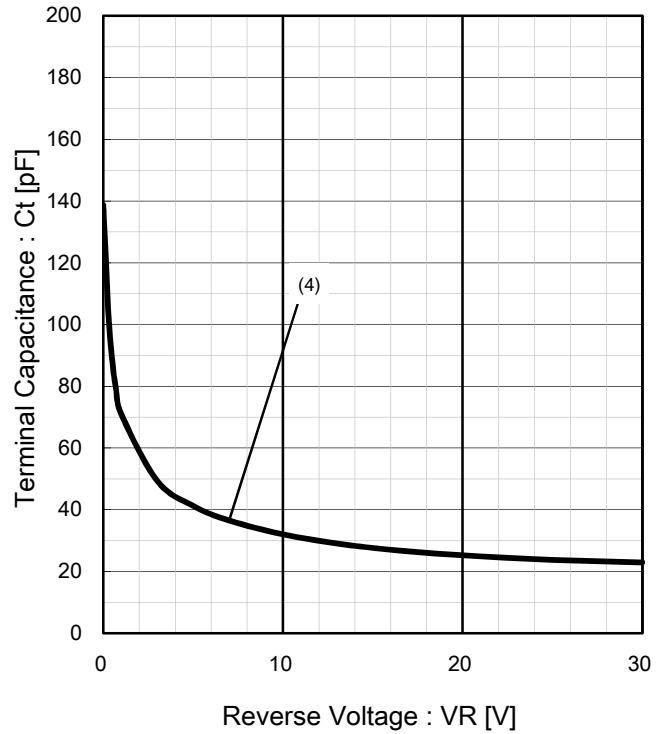

IR - VR / Typical Data

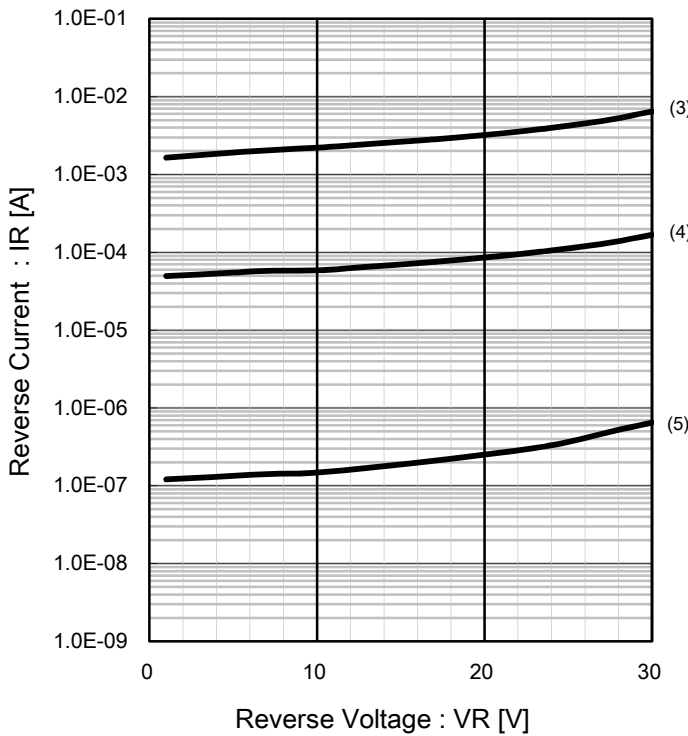

(Graph legends)

(1)	Ta = 150 °C
(2)	Ta = 125 °C
(3)	Ta = 85 °C
(4)	Ta = 25 °C
(5)	Ta = -40 °C



Electrical Characteristics Technical Data (Reference)

PF(AV) - IF(AV) / Typical Data

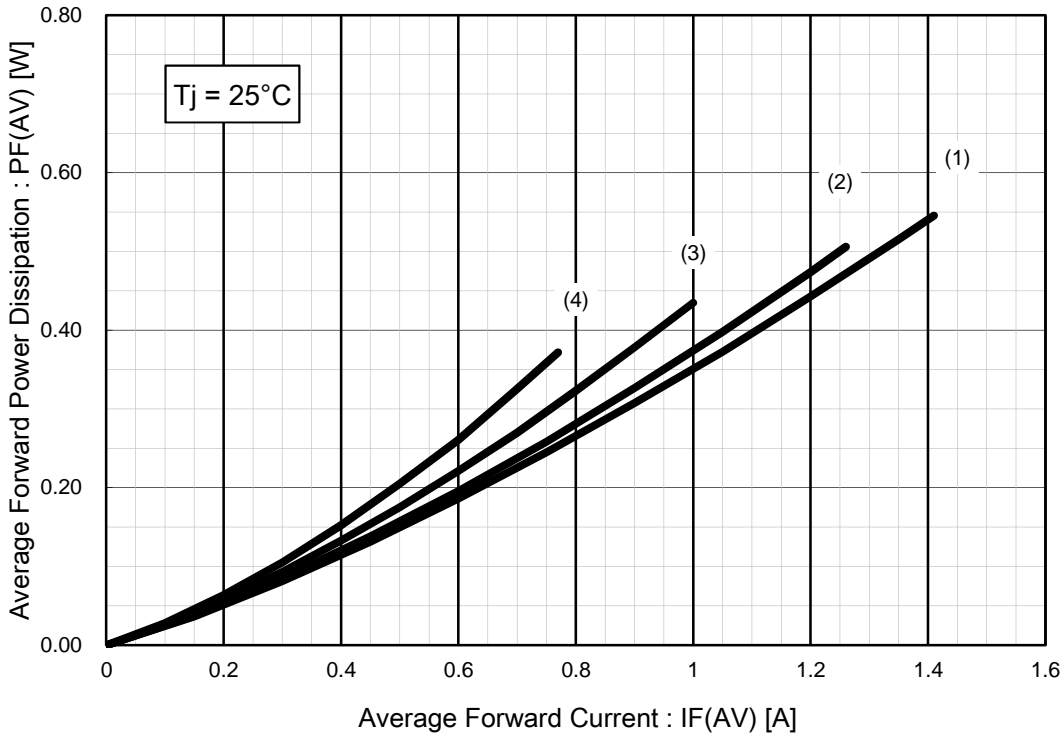

PR(AV) - VR / Typical Data

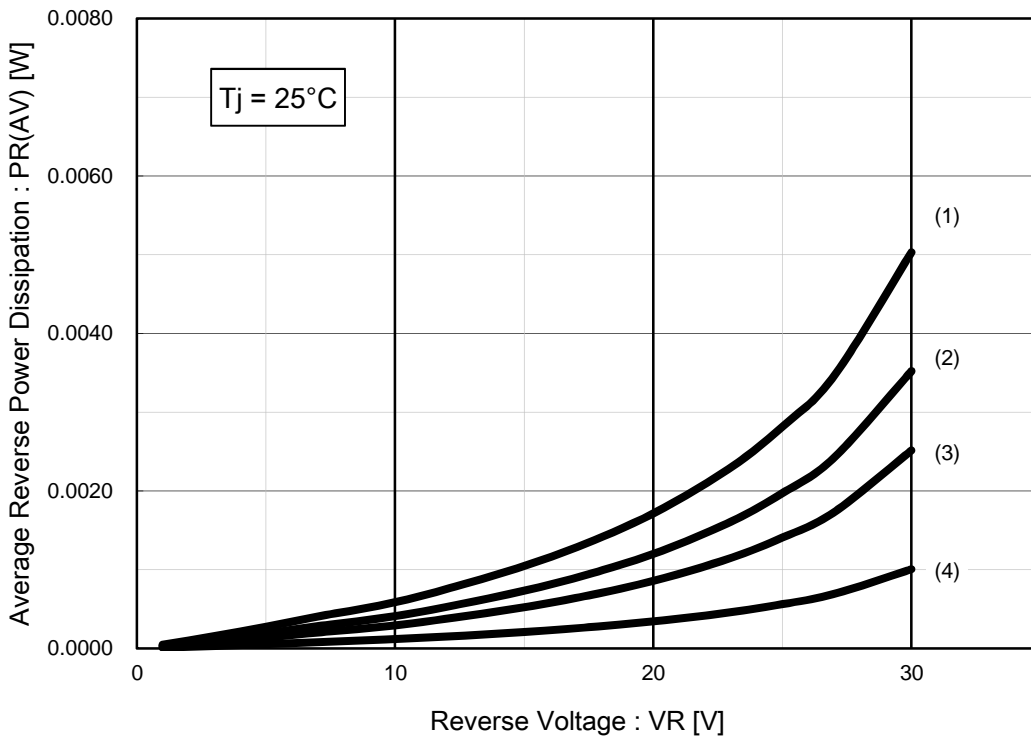



Electrical Characteristics Technical Data (Reference)

PF(AV) - IF(AV) / Typical Data

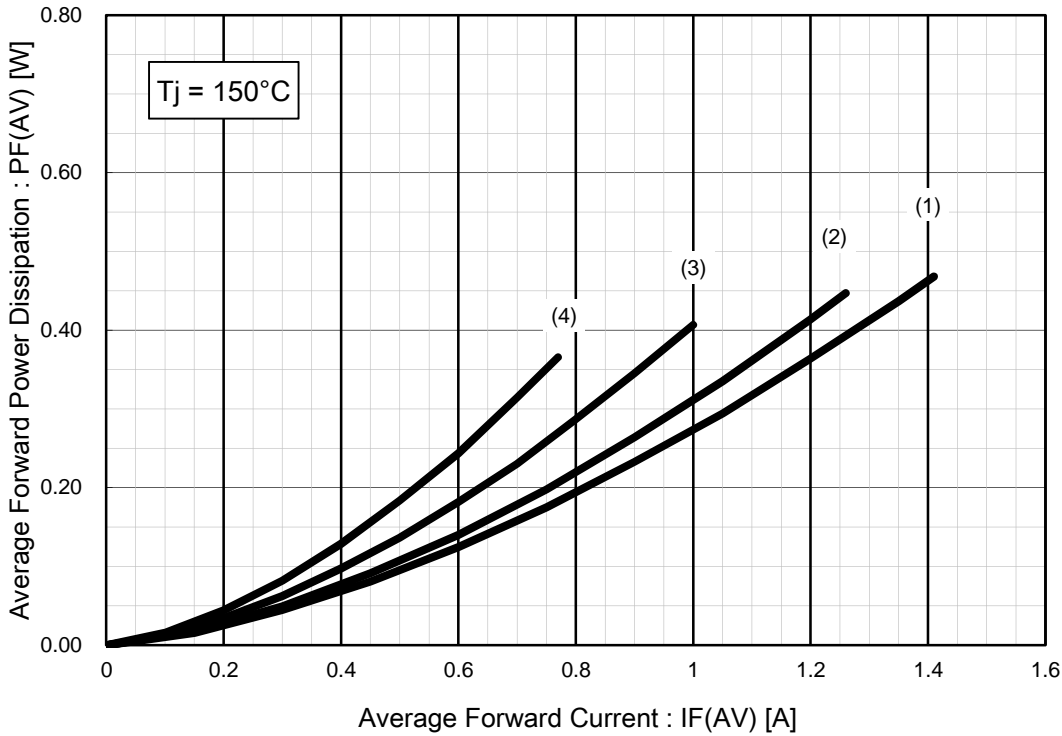

PR(AV) - VR / Typical Data

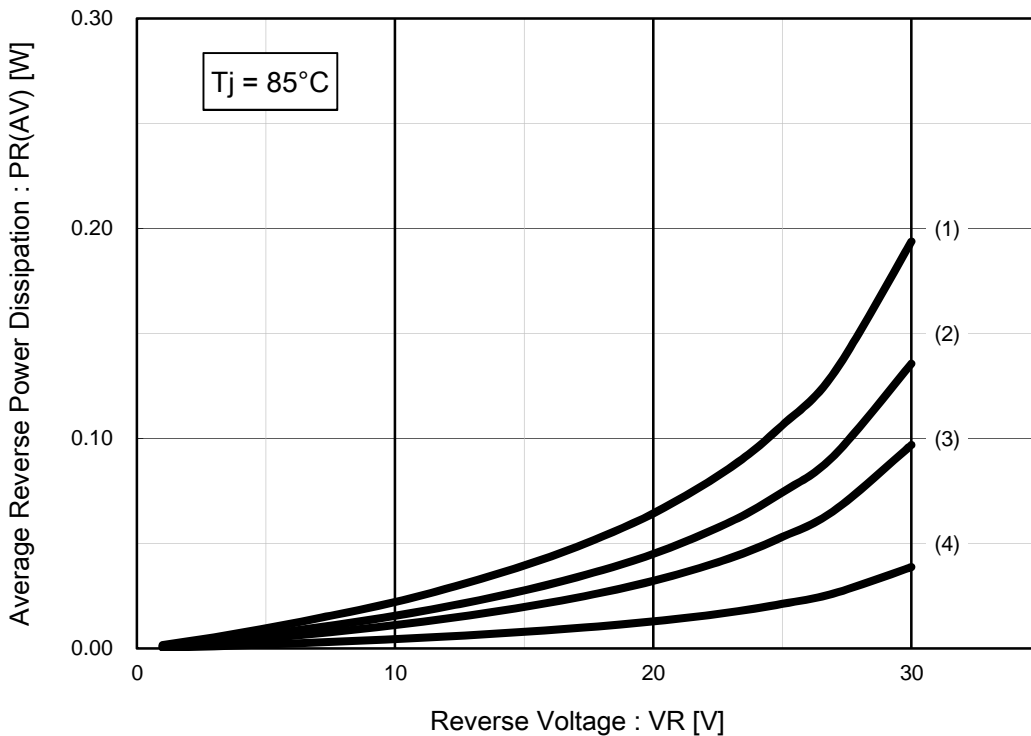



■ Thermal Characteristics

Parameter	Symbol	Conditions	Min	Typ	Max	Unit
Thermal Resistance, Junction to Solder Point	$R_{th(j-sp)}$	$T_a = 25^{\circ}C$ , in free air	-	20	-	$^{\circ}C/W$
Thermal Resistance, Junction to Ambient *1	$R_{th(j-a)}$	$T_a = 25^{\circ}C$ , in free air	-	92	-	$^{\circ}C/W$
Thermal Resistance, Junction to Ambient *2	$R_{th(j-a)}$	$T_a = 25^{\circ}C$ , in free air	-	170	-	$^{\circ}C/W$

Note) \*1: Device mounted on a FR4 PCB (25.4mm×25.4mm, 1mm thick), copper wiring (620.0mm<sup>2</sup> area, 36μm thick).  
 \*2: Device mounted on a FR4 PCB (25.4mm×25.4mm, 1mm thick), copper wiring (108.6mm<sup>2</sup> area, 36μm thick).

(Evaluation board outline)

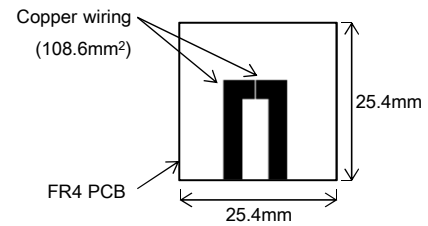
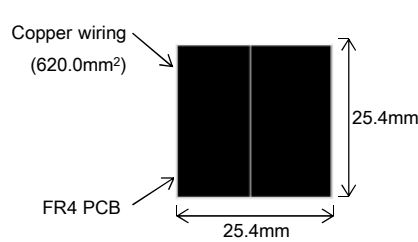

Thermal Characteristics Technical Data (Reference)

$R_{th} - T^{*1} / \text{Typical Data}$

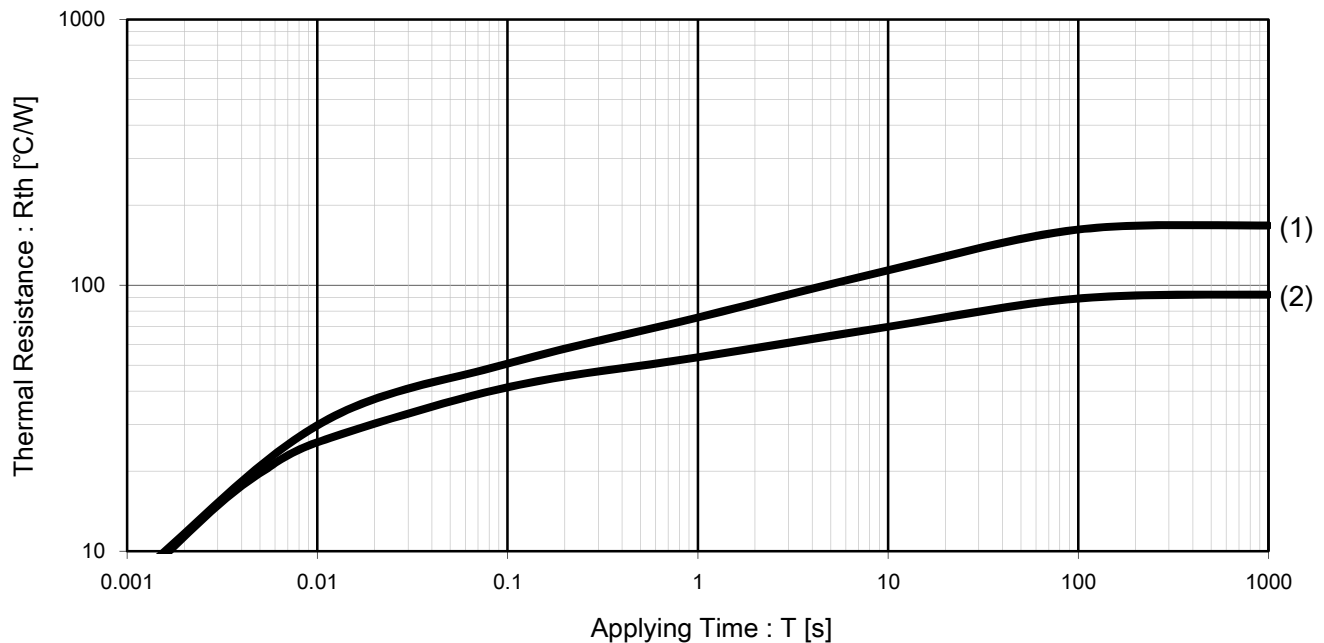

Note) \*1: Single pulse measurement  
 (Waveform definition)

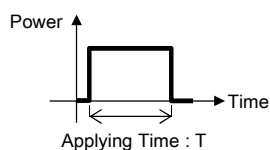

(Graph legends)

(1)	Device mounted on a FR4 PCB (25.4mm×25.4mm, 1mm thick), copper wiring (108.6mm <sup>2</sup> area, 36μm thick).
(2)	Device mounted on a FR4 PCB (25.4mm×25.4mm, 1mm thick), copper wiring (620.0mm <sup>2</sup> area, 36μm thick).



Thermal Characteristics Technical Data (Reference)

Effective Transient Thermal Resistance -  $T_p^{*1}$  / Typical Data

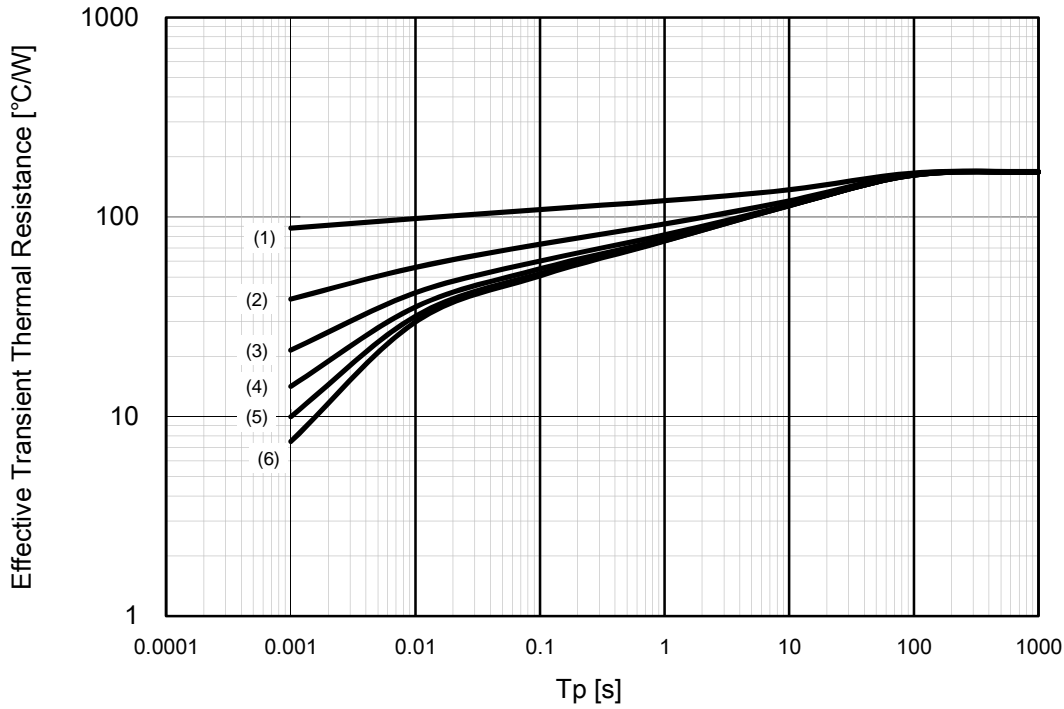

(Evaluation board outline)

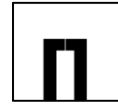

(Waveform definition)

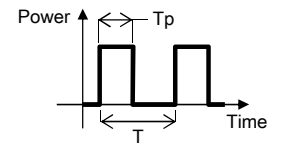

$$\text{Duty Cycle : } \sigma = \frac{T_p}{T}$$

(Graph legends)

(1)	$\sigma = 0.5$
(2)	$\sigma = 0.2$
(3)	$\sigma = 0.1$
(4)	$\sigma = 0.05$
(5)	$\sigma = 0.02$
(6)	$\sigma = 0$

Effective Transient Thermal Resistance -  $T_p^{*2}$  / Typical Data

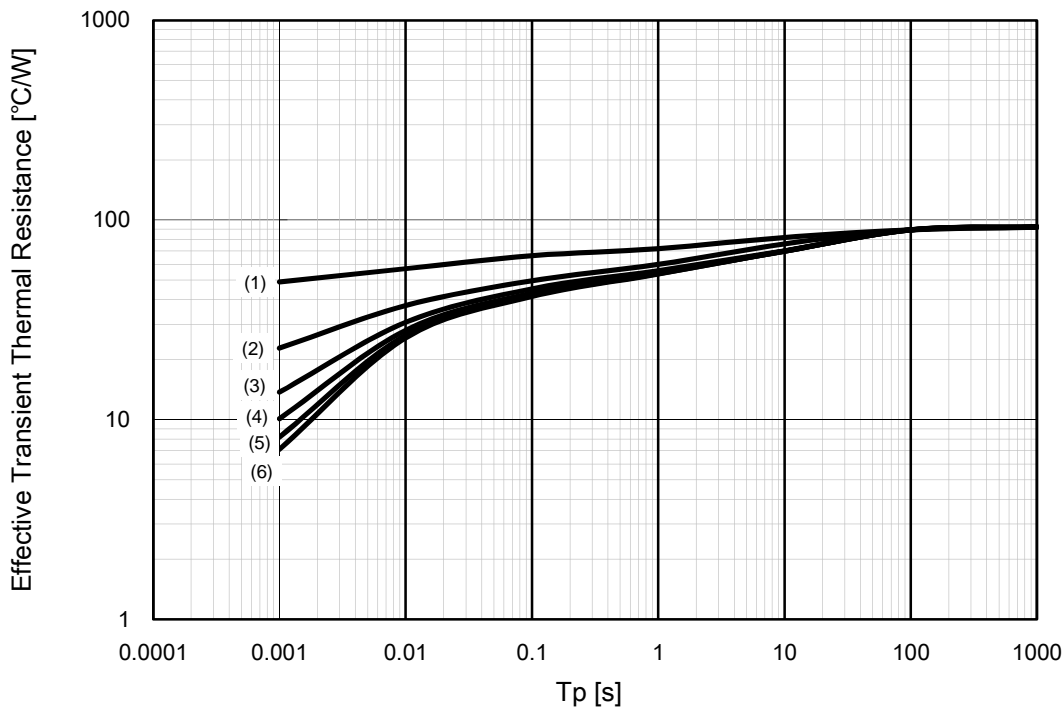

(Evaluation board outline)



(Waveform definition)

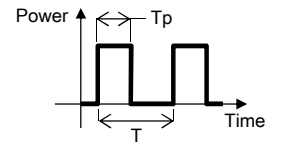

$$\text{Duty Cycle : } \sigma = \frac{T_p}{T}$$

(Graph legends)

(1)	$\sigma = 0.5$
(2)	$\sigma = 0.2$
(3)	$\sigma = 0.1$
(4)	$\sigma = 0.05$
(5)	$\sigma = 0.02$
(6)	$\sigma = 0$

Note) \*1: Device mounted on a FR4 PCB (25.4mm×25.4mm, 1mm thick), copper wiring (108.6mm<sup>2</sup> area, 36μm thick).  
\*2: Device mounted on a FR4 PCB (25.4mm×25.4mm, 1mm thick), copper wiring (620.0mm<sup>2</sup> area, 36μm thick).



Power Derating Technical Data (Reference)

IF(AV) - Ta<sup>\*1</sup> / Typical Data

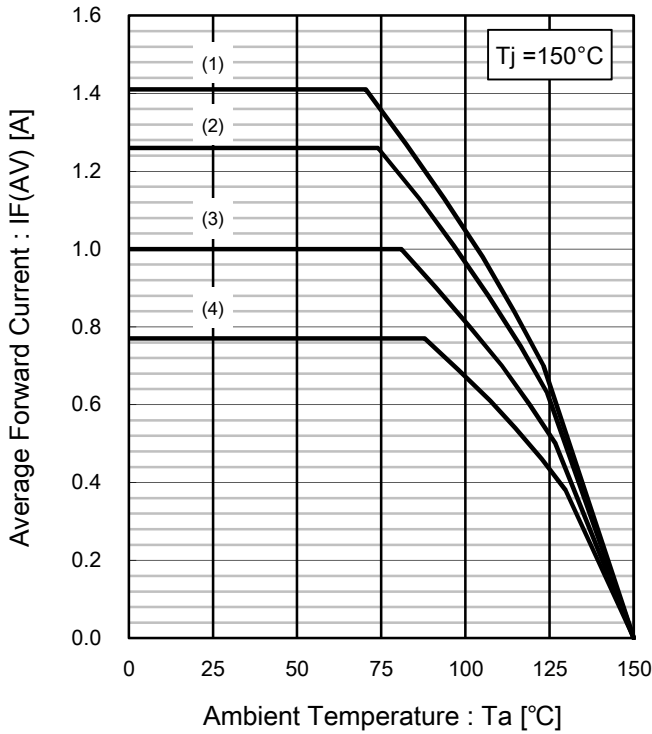

IF(AV) - Ta<sup>\*2</sup> / Typical Data

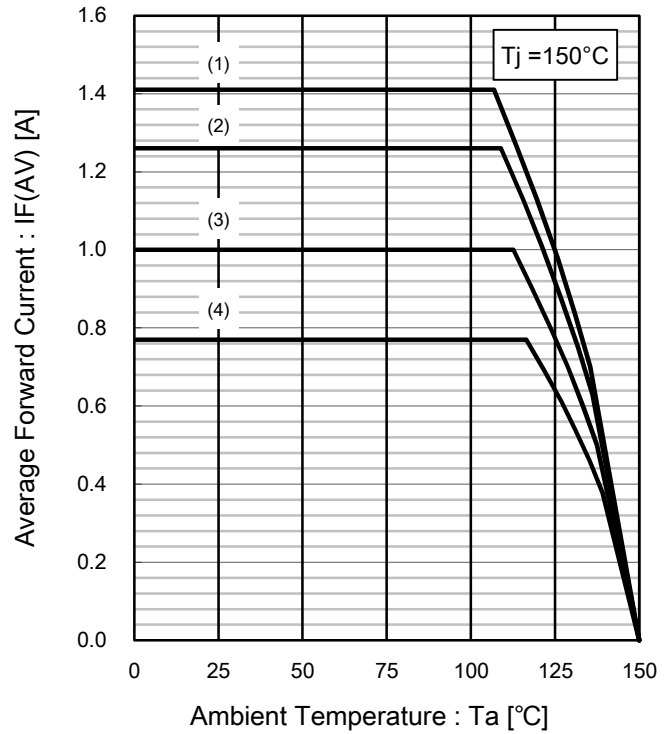

IF(AV) - Tsp / Typical Data

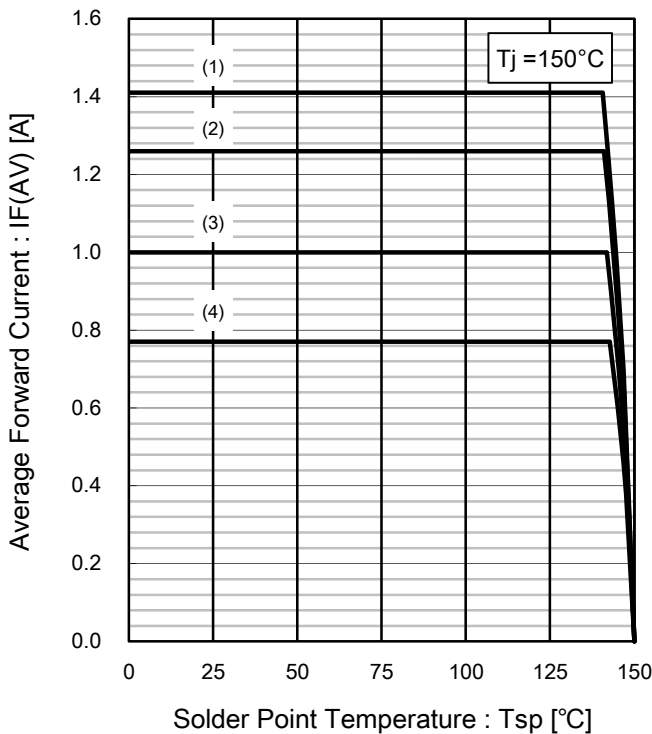

(Graph legends)

(1)	$\sigma = 1.0$
(2)	$\sigma = 0.8$
(3)	$\sigma = 0.5$
(4)	$\sigma = 0.3$

(Waveform definition)

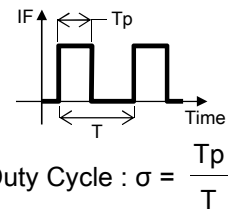

Note)

\*1: Device mounted on a FR4 PCB (25.4mm×25.4mm, 1mm thick), copper wiring (108.6mm<sup>2</sup> area, 36μm thick).

(Evaluation board outline)



\*2: Device mounted on a FR4 PCB (25.4mm×25.4mm, 1mm thick), copper wiring (620.0mm<sup>2</sup> area, 36μm thick).

(Evaluation board outline)





DCSP1006010-N1

Unit: mm

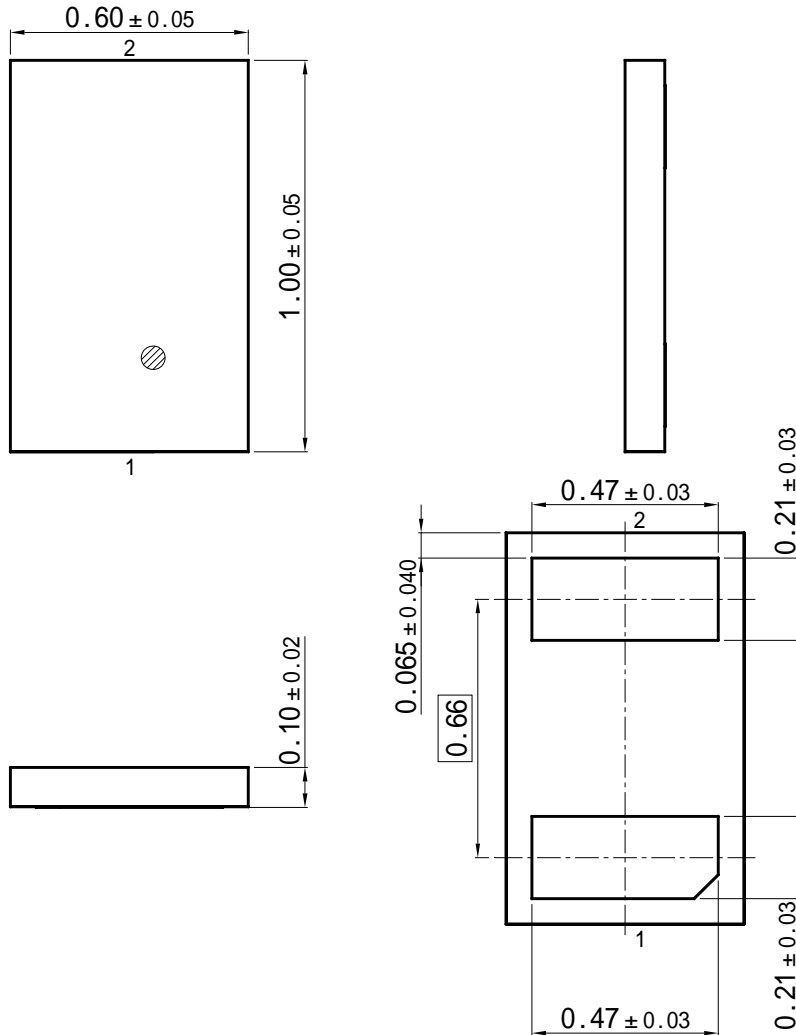

■ Land Pattern (Reference)

Unit: mm

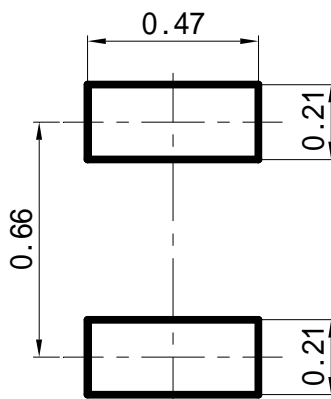



## Request for your special attention and precautions in using the technical information and semiconductors described in this book

- (1) If any of the products or technical information described in this book is to be exported or provided to non-residents, the laws and regulations of the exporting country, especially, those with regard to security export control, must be observed.
- (2) The technical information described in this book is intended only to show the main characteristics and application circuit examples of the products. No license is granted in and to any intellectual property right or other right owned by Panasonic Corporation or any other company. Therefore, no responsibility is assumed by our company as to the infringement upon any such right owned by any other company which may arise as a result of the use of technical information described in this book.
- (3) The products described in this book are intended to be used for general applications (such as office equipment, communications equipment, measuring instruments and household appliances), or for specific applications as expressly stated in this book.  
Consult our sales staff in advance for information on the following applications:
  - Special applications (such as for airplanes, aerospace, automotive equipment, traffic signaling equipment, combustion equipment, life support systems and safety devices) in which exceptional quality and reliability are required, or if the failure or malfunction of the products may directly jeopardize life or harm the human body.It is to be understood that our company shall not be held responsible for any damage incurred as a result of or in connection with your using the products described in this book for any special application, unless our company agrees to your using the products in this book for any special application.
- (4) The products and product specifications described in this book are subject to change without notice for modification and/or improvement. At the final stage of your design, purchasing, or use of the products, therefore, ask for the most up-to-date Product Standards in advance to make sure that the latest specifications satisfy your requirements.
- (5) When designing your equipment, comply with the range of absolute maximum rating and the guaranteed operating conditions (operating power supply voltage and operating environment etc.). Especially, please be careful not to exceed the range of absolute maximum rating on the transient state, such as power-on, power-off and mode-switching. Otherwise, we will not be liable for any defect which may arise later in your equipment.  
Even when the products are used within the guaranteed values, take into the consideration of incidence of break down and failure mode, possible to occur to semiconductor products. Measures on the systems such as redundant design, arresting the spread of fire or preventing glitch are recommended in order to prevent physical injury, fire, social damages, for example, by using the products.
- (6) Comply with the instructions for use in order to prevent breakdown and characteristics change due to external factors (ESD, EOS, thermal stress and mechanical stress) at the time of handling, mounting or at customer's process. When using products for which damp-proof packing is required, satisfy the conditions, such as shelf life and the elapsed time since first opening the packages.
- (7) This book may be not reprinted or reproduced whether wholly or partially, without the prior written permission of our company.