

CZT5551

**SURFACE MOUNT SILICON
NPN TRANSISTOR**

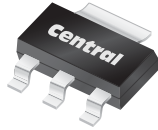

SOT-223 CASE



www.centrasemi.com

DESCRIPTION:

The CENTRAL SEMICONDUCTOR CZT5551 is a silicon NPN transistor manufactured by the epitaxial planar process, epoxy molded in a surface mount package, designed for high voltage amplifier applications.

MARKING: FULL PART NUMBER

MAXIMUM RATINGS: ($T_A=25^\circ\text{C}$)

Collector-Base Voltage
Collector-Emitter Voltage
Emitter-Base Voltage
Continuous Collector Current
Power Dissipation
Operating and Storage Junction Temperature
Thermal Resistance

SYMBOL		UNITS
V_{CBO}	180	V
V_{CEO}	160	V
V_{EBO}	6.0	V
I_C	600	mA
P_D	2.0	W
T_J, T_{stg}	-65 to +150	$^\circ\text{C}$
θ_{JA}	62.5	$^\circ\text{C/W}$

ELECTRICAL CHARACTERISTICS: ($T_A=25^\circ\text{C}$ unless otherwise noted)

SYMBOL	TEST CONDITIONS	MIN	MAX	UNITS
I_{CBO}	$V_{CB}=120\text{V}$		50	nA
I_{CBO}	$V_{CB}=120\text{V}, T_A=100^\circ\text{C}$		50	μA
I_{EBO}	$V_{EB}=4.0\text{V}$		50	nA
BV_{CBO}	$I_C=100\mu\text{A}$	180		V
BV_{CEO}	$I_C=1.0\text{mA}$	160		V
BV_{EBO}	$I_E=10\mu\text{A}$	6.0		V
$V_{CE(SAT)}$	$I_C=10\text{mA}, I_B=1.0\text{mA}$		0.15	V
$V_{CE(SAT)}$	$I_C=50\text{mA}, I_B=5.0\text{mA}$		0.20	V
$V_{BE(SAT)}$	$I_C=10\text{mA}, I_B=1.0\text{mA}$		1.00	V
$V_{BE(SAT)}$	$I_C=50\text{mA}, I_B=5.0\text{mA}$		1.00	V
h_{FE}	$V_{CE}=5.0\text{V}, I_C=1.0\text{mA}$	80		
h_{FE}	$V_{CE}=5.0\text{V}, I_C=10\text{mA}$	80	250	
h_{FE}	$V_{CE}=5.0\text{V}, I_C=50\text{mA}$	30		
f_T	$V_{CE}=10\text{V}, I_C=10\text{mA}, f=100\text{MHz}$	100	300	MHz
C_{ob}	$V_{CB}=10\text{V}, I_E=0, f=1.0\text{MHz}$		6.0	pF
C_{ib}	$V_{EB}=0.5\text{V}, I_C=0, f=1.0\text{MHz}$		20	pF
h_{fe}	$V_{CE}=10\text{V}, I_C=1.0\text{mA}, f=1.0\text{kHz}$	50	200	
NF	$V_{CE}=5.0\text{V}, I_C=200\mu\text{A}, R_S=10\Omega,$ $f=10\text{Hz to } 15.7\text{kHz}$		8.0	dB

R6 (11-December 2017)

CZT5551
SURFACE MOUNT SILICON
NPN TRANSISTOR



SOT-223 CASE - MECHANICAL OUTLINE

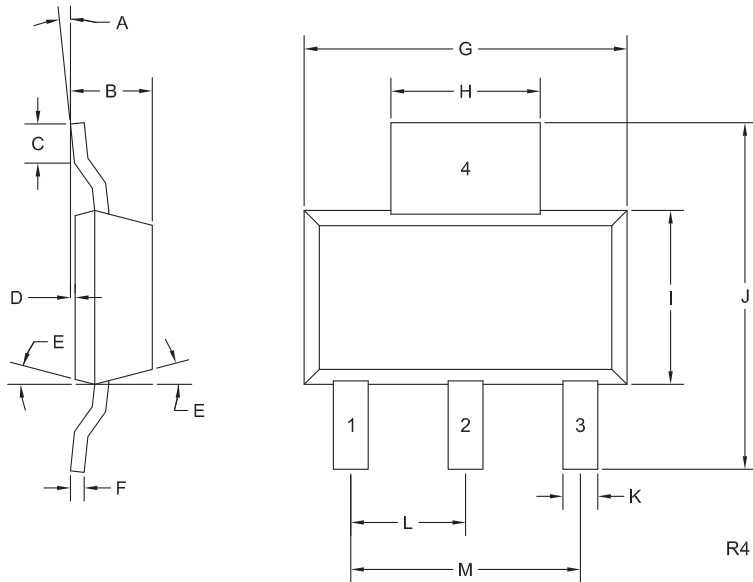

LEAD CODE:

- 1) Base
- 2) Collector
- 3) Emitter
- 4) Collector

MARKING:
FULL PART NUMBER

DIMENSIONS				
SYMBOL	INCHES		MILLIMETERS	
	MIN	MAX	MIN	MAX
A	0°	10°	0°	10°
B	0.059	0.071	1.50	1.80
C	0.018	---	0.45	---
D	0.000	0.004	0.00	0.10
E	10°		10°	
F	0.009	0.014	0.23	0.35
G	0.248	0.264	6.30	6.70
H	0.114	0.122	2.90	3.10
I	0.130	0.146	3.30	3.70
J	0.264	0.287	6.70	7.30
K	0.024	0.033	0.60	0.85
L	0.091		2.30	
M	0.181		4.60	

SOT-223 (REV: R4)

R6 (11-December 2017)

CZT5551
SURFACE MOUNT SILICON
NPN TRANSISTOR



TYPICAL ELECTRICAL CHARACTERISTICS

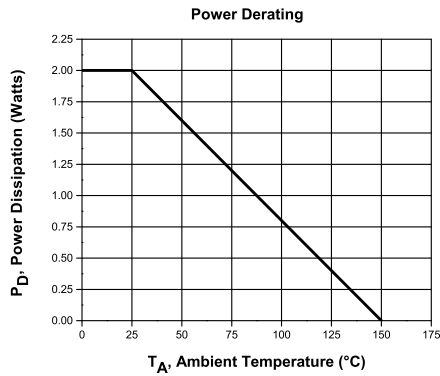
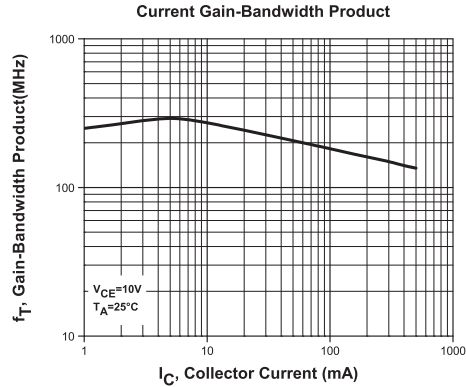
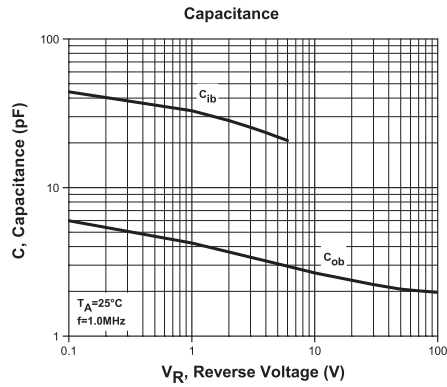
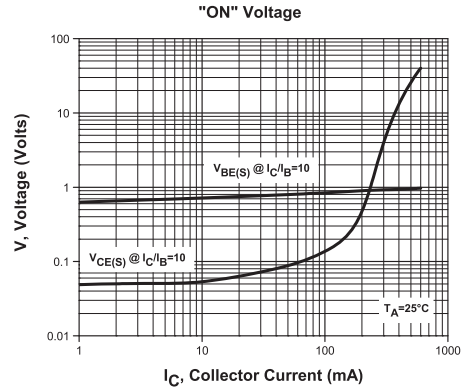
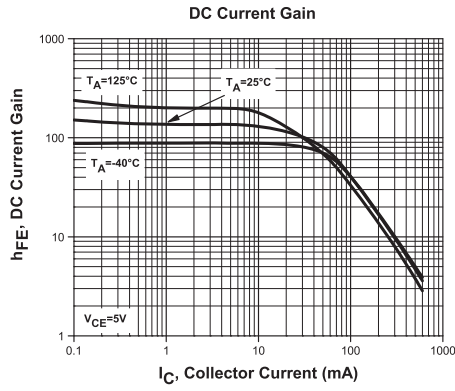

R6 (11-December 2017)

OUTSTANDING SUPPORT AND SUPERIOR SERVICES



PRODUCT SUPPORT

Central's operations team provides the highest level of support to insure product is delivered on-time.

- Supply management (Customer portals)
- Inventory bonding
- Consolidated shipping options
- Custom bar coding for shipments
- Custom product packing

DESIGNER SUPPORT/SERVICES

Central's applications engineering team is ready to discuss your design challenges. Just ask.

- Free quick ship samples (2nd day air)
- Online technical data and parametric search
- SPICE models
- Custom electrical curves
- Environmental regulation compliance
- Customer specific screening
- Up-screening capabilities
- Special wafer diffusions
- PbSn plating options
- Package details
- Application notes
- Application and design sample kits
- Custom product and package development

REQUESTING PRODUCT PLATING

1. If requesting Tin/Lead plated devices, add the suffix " TIN/LEAD" to the part number when ordering (example: 2N2222A TIN/LEAD).
2. If requesting Lead (Pb) Free plated devices, add the suffix " PBFREE" to the part number when ordering (example: 2N2222A PBFREE).

CONTACT US

Corporate Headquarters & Customer Support Team

Central Semiconductor Corp.
145 Adams Avenue
Hauppauge, NY 11788 USA
Main Tel: (631) 435-1110
Main Fax: (631) 435-1824
Support Team Fax: (631) 435-3388
www.centalsemi.com

Worldwide Field Representatives:
www.centalsemi.com/wwreps

Worldwide Distributors:
www.centalsemi.com/wwdistributors

For the latest version of Central Semiconductor's **LIMITATIONS AND DAMAGES DISCLAIMER**, which is part of Central's Standard Terms and Conditions of sale, visit: www.centalsemi.com/terms