

460 Handheld 20MHz Digital Oscilloscope

(Ver.)

User's Guide



The Value Leader™

www.tpi-thevalueleader.com

Test Products International, Inc.
9615 SW Allen Blvd.
Portland, OR 97005
Ph: 503-520-9197 ♦ Fax: 503-520-1225
E-mail: info@tpi-thevalueleader.com

Copyright © 2001
Test Products International, Inc.
All Rights Reserved
08/01

Table of Contents

C1 - Introduction.....	C1-1
Features	C1-2
Specifications	C1-3
Scope Modes	C1-3
Multimeter Modes	C1-5
C2 - Getting Started	C2-1
Equipment Needed	C2-1
460 Setup	C2-1
Measuring Voltage	C2-3
Measuring Frequency	C2-3
Measuring Resistance	C2-4
Testing Continuity	C2-4
Diode Test	C2-4
C3 - Operation.....	C3-1
Principal Connectors and Keys	C3-1
Key / Screen Menus	C3-3
C4 - Advanced Functions	C4-1
Triggering	C4-1
Trend Mode	C4-1
Glitch Capture	C4-2
Saving Screens	C4-2
Using the 10:1 Probe	C4-3
10:1 Probe Compensation Adjustment	C4-3
C5 - Using Adapters	C5-1
Temperature Adapter - A301.....	C5-1
High Current Adapter - A251 / A256 / A296	C5-1

Low Current Adapter - A254	C5-2
Current Shunt Adapter - A130	C5-2
Pressure Adapter - A620	C5-2
PC Software & RS232 Cable - A404	C5-3
C6 - Safety Considerations	C6-1
Instrument	C6-1
Environmental	C6-2
Appendix A - Test and Calibration	A-1
Appendix B - Maintenance Considerations	B-1
Appendix C - Glossary	C-1
Appendix D - Optional RS-232C / PC Interface.....	D-1
Appendix E - Troubleshooting	E-1

Chapter 1

Introduction

This manual describes the TPI Scope Plus 460 and its functions. Normal and advanced functions are covered in detail, as well as interactions with computers and other instrumentation. A full chapter is also devoted to safety considerations, both instrument based and interactively. The following is a brief chapter and appendix summary:

- Chapter 1 - Covers the introduction, features and Specifications.
- Chapter 2 - Getting Started gets the new user up and running in the shortest time possible. The basic functions are introduced in a hands on style designed to familiarize the user with the keypad and screen display.
- Chapter 3 - Explains all the normal functions of the TPI Scope Plus 460, including buttons, menus, screen displays, and a sequencing guide for both external key actions and their interaction with software driven menus.
- Chapter 4 - Explains more advanced functions such as triggering, glitch capture, trend mode, and saving screens.
- Chapter 5 - Explains and illustrates uses of probes and adapters including pressure, temperature, and current shunt adapters. This chapter also introduces general aspects of the optional optically isolated RS-232 interface.
- Chapter 6 - This important chapter details operating methods and tips designed to preserve both the life of your instrument, and safety factors to prevent human injury. The text is divided into Instrument and environmental safety subsections.
- Appendix A - This appendix covers what to look for, and how to make simple tests to find out if your TPI Scope Plus 460 requires replacement parts or calibration.
- Appendix B - This Maintenance appendix gives tips on how to keep your TPI Scope Plus 460 in top operating condition by assuring constant peak performance. The appendix also covers battery servicing and replacement.
- Appendix C - A glossary describing the meanings of terms associated with the 460 and its working environment.

Appendix D - This appendix introduces and explains the powerful RS-232C Interface option. All aspects are covered from Installation to Special Applications.

Appendix E - This Troubleshooting appendix covers problems that may arise during installation or operation of your new TPI Scope Plus 460.

Features

The following features exist for the TPI Scope Plus 460:

- **20 MHz Bandwidth**
Enough bandwidth to capture signals from AC/DC drive motors, sensors, actuators, line and control voltages, UPS and industrial machines.
- **Sample Rate**
A real time sampling of 25 megasamples/sec to capture spikes and dropouts of industrial signals.
- **Dual Input**
View two waveforms on the display for comparison and troubleshooting.
- **True RMS DMM**
Includes a 4000 count True RMS DMM that measures AC/DC volts to 600V, frequency to 20MHz, resistance to 20M Ohm, diode test and continuity audible tone.
- **Autoranging**
Autoranging capability across Voltage, Timebase and Frequency.
- **Bright LCD Backlight**
Easy-to-see display in any light condition with user-adjustable backlight brightness levels
- **Optically Isolated RS232 Output**
Transfer data safely without any direct connections to your computer s systems security.
- **Optional Accessories**
Temperature Adapter to measure temperature from -40 to 500°F (A301).
Pressure Adapter to measure pressure from -30 to 500psi (A620).
Protective Boot (A405).
Soft Carrying Case with Shoulder Strap (A905).
RS232 cable and software (A404).
Current Adapters:

- o A254 - For measuring low current in milliamps
- o A256 - Up to 400 AC/DC amps
- o A296 - Up to 1000 AC/DC amps

Specifications

Display:

Size	76mm X 76mm (3" X 3")
Pixels	240 X 240 pixels
LCD type	STN Normally Gray or Black
Back Light	CCFL

Memory:

Waveform	Screens (2)
Setup	User setup (1)

Power:

External	Power Adapter (5.5V / 2A)
Internal Battery	Ni-MH 1.2V X 4
Battery Operating Time	More than 2.5 hours with bright backlight
Charging Time	10 hours (in power off condition)

SCOPE MODES

Horizontal:

Samples per division	25 samples / div.
Time/division	Equivalent sampling 50ns to 500ns/div Real time sampling 1us to 2s/div
Modes	Single, Normal, Auto, Glitch
Accuracy	Real time sampling +/- (0.1% + 0.04 time/div) Equivalent sampling +/- (0.5% + 0.08 time/div)

Vertical:

Sampling Rate	25 Mega samples per second
Bandwidth (-3dB)	DC Coupled 1:1 shielded test leads ; DC to 10MHz Coaxial cable (50 Ω) ; DC to 20MHz AC Coupled 1:1 shielded test leads ; 10Hz to 10MHz Coaxial cable (50 Ω) ; 10Hz to 20MHz
Resolution	8 bits
Channel	2
Coupling	AC,DC,GND

Input impedance	Approx. 1M Ohm
Sensitivity	50mV to 200V/div 1,2,5 sequence
Accuracy	+/- (3% + 0.05 range/div)
Display modes	CH1, Dual
Maximum Input Voltage	600V

Trigger:

Position	Ver 1; Fixed Position / Ver 3; Adjustable Position
Mode	Free run, normal
Source	Internal (CH1/CH2)
Slope	Positive/Negative
Sensitivity	Real time sampling 2 divisions or more Equivalent sampling 3 divisions or more

Trend Plot:

Plot Time	30sec/div to 1-hour/div
Plot Data Type	Max / Min Selectable

Temperature Measurement:

Optional Adapter	A301 (k - Type thermocouple)
Range	-40 F to 500 F
Accuracy	+/- (1.5% + 5 digits)

Pressure / Vacuum Measurement:

Optional Adapter	A620
Range	Pressure 500 psi Vacuum 30 inHg
Accuracy	Pressure +/- (5% + 5 digits) Vacuum +/- (1.5% + 5 digits)

Current Measurement:

Optional Adapter 1	A251 (AC AMPS)
Range	0 - 40A / 40 - 400A
Accuracy (0 - 40A)	+/- (2.0% + 10 digits , 50 / 60 Hz)
(40 - 400A)	+/- (2.0% + 10 digits , 50 / 60 Hz)
Optional Adapter 2	A256 (AC/DC AMPS)
Range	0 - 40A / 40 - 400A
Accuracy (0 - 40A)	+/- (2.0% + 10 digits , 50 / 60 Hz)
(40 - 400A)	+/- (2.0% + 10 digits , 50 / 60 Hz)

Optional Adapter 3	A296 (AC/DC AMPS)
Range	0 - 400A / 400 - 1000A
Accuracy (0 - 400A)	+/- (2.0% + 10 digits , 50 / 60 Hz)
(400 - 1000A)	+/- (2.0% + 10 digits , 50 / 60 Hz)

MULTIMETER MODES

DC Volts (CH1/CH2)

Range	Resolution	Accuracy
400mV	0.1mV	+/- (0.5% + 5 digits)
4V	0.001V	+/- (0.5% + 5 digits)
40V	0.01V	+/- (0.5% + 5 digits)
400V	0.1V	+/- (0.5% + 5 digits)
600V	1V	+/- (0.5% + 5 digits)

AC Volts (CH1/CH2)

Range	Resolution	Accuracy
400mV	0.1mV	20Hz to 50Hz; +/- (2% + 20 digits)
4V	0.001V	50Hz to 1kHz; +/- (1% + 10 digits)
40V	0.01V	1kHz to 20kHz; +/- (2% + 10 digits)
400V	0.1V	40Hz to 400Hz; +/- (1% + 10 digits)
600V	1V	40Hz to 400Hz; +/- (1% + 10 digits)

Frequency (CH1/CH2)

Range	Resolution	Accuracy
100Hz	0.01Hz	+/- (1.0% + 10 digits)
1KHz	0.1Hz	+/- (0.5% + 5 digits)
10KHz	1Hz	+/- (0.5% + 5 digits)
100KHz	10Hz	+/- (0.5% + 5 digits)
1MHz	100Hz	+/- (0.5% + 5 digits)
10MHz	1kHz	+/- (0.5% + 5 digits)
20MHz	10kHz	+/- (2.5% + 5 digits)

OHM (CH1 ONLY)

Range	Resolution	Accuracy
400 Ohm	0.1 Ohm	+/- (0.75% + 5 digits)
4k Ohm	1 Ohm	+/- (0.5% + 5 digits)
40k Ohm	10 Ohm	+/- (0.5% + 5 digits)
400k Ohm	100 Ohm	+/- (0.5% + 5 digits)
4M Ohm	1k Ohm	+/- (1.0% + 10 digits)
20M Ohm	10k Ohm	+/- (3.0% + 20 digits)

Continuity (CH1 ONLY)**Range**

4 K ohm

Resolution

1 ohm

Accuracy

Beeps < 0.1 K ohm , +/- (2% + 5 digits)

Diode (CH1 ONLY)**Range**

2 V

Resolution

1 mV

Accuracy

Open circuit voltage < 5 V

Short circuit current < 5 mA

Reading accuracy; +/- (2% + 5 digits)

dBV (CH1 ONLY) $\text{dBV} = 20 \log |V_{\text{in}}|$ **dBm (CH1 ONLY)**

0 dBm = 1 mW

Chapter 2

Getting Started

This chapter will get you started with the TPI Scope Plus 460. It will include initial power up, followed by a series of DMM and static tests. More detailed operations will be the subject of the next chapter. Refer also to the chapters and appendices covering specifications and maintenance if you run into problems outside the scope of this chapter. Also feel free to check with service support using the phone numbers given at the beginning of this manual.

Equipment Needed

Required:

- Fully operational TPI Scope Plus 460 with batteries fully charged
- Set of probes with alligator clip attachments available
- Set of fixed or variable resistances.
- Set of fixed or variable inductances.
- Set of fixed or variable capacitances.
- Static or variable DC voltage source.

Optional:

- Signal generator source with varied outputs
- Random glitch or voltage spike generator

460 Setup

1. Use the tilt stand if necessary to set up the instrument in a readable position.
2. Switch the unit on by pressing and releasing the **POWER ON** button.
3. If the **Power** adapter is attached, check the battery level by pulling out the adapter and checking if there is any change to the brightness of the display (For optimal performance, the battery should be fully charged even with the **Power** adapter attached).
4. Check the Contrast. Refer to Figure 2-1, and press the **USER** button. Note the Contrast menu button is displayed on the screen above F2. - Press F2 and note the menu item on the screen is now darkened. Press the Up arrow to increase the contrast and the Down arrow to reduce the contrast.
5. Check the Brightness (-there are ten levels). Refer to Figure 2-1, and press the Brightness button (Sun Icon) to decrease the brightness. To increase the brightness, continue pressing the brightness button until you have reached the bottom level, at which time it will revert to the maximum brightness level.

3. Press F2 (below the Contrast Label).

4. Press the Up or Down direction arrows to change contrast.



2. Press the User Button

1. Press the POWER ON Button

Figure 2-1. Contrast Adjustment with Low Visibility

NOTE: *The Brightness control effects the backlighting whereas Contrast effects the intensity of the liquid crystal display (both for the tracing beams and the text display).*

6. You have now completed the basic setup. Press Ch A (Channel A), to exit the user setup mode and ready the instrument for Multimeter operations.

Measuring Voltage

1. With the 460 set for Input A (**Ch A** button), use the down arrow to set the highlight on **DCV**. Press **Enter**.
2. Press the green **V** key, and connect the probes to a DC Voltage source. The voltage will appear in alphanumeric text at the top left of the screen. The trace line A should be steady, but if there are any AC components present on the line it will also show these (especially in the case of partially rectified AC).

NOTE: *Pressing the Green key **V** selection first will ensure you are not being limited by the millivolt range. If the voltage reading is then read as a small value, use the **mV** side of the green rocker key to display the millivolt range on the screen.*

3. Disconnect the DC Voltage source and press **Ch A** (Channel A blue button). Use the Up arrow to move the screen highlight to **ACV**. Press **Enter**.
4. Press the green **V** key, and connect the probes to the AC source. The voltage can be read at the top left of the screen expressed as an RMS value. The trace line A will show the shape of the AC voltage source.

Measuring Frequency

1. With the 460 set for Input A (**Ch A** button), use the down arrow to set the highlight on **Freq**. Press **Enter**.
2. Connect the probes to a frequency source. The frequency will be shown in alphanumeric text at the top left of the screen. The trace line A will show the nature of the frequency source.

Notes on Trace Stability:

a). *Ensuring that the Channel B trace is off when making frequency measurements on the A channel, will reduce clutter on the screen, and make the A trace easier to read.*

b). *Using the HOLD/RUN button will freeze the trace and allow waveform characteristics to be measured precisely against the background grid.*

Measuring Resistance

1. With the 460 set for Input A (**Ch A** button), use the down arrow to set the highlight on OHM. Press **Enter**.
2. Connect the probes across the resistance source. The resistance value is shown in two forms. First as alphanumeric text at the top of the screen. Secondly, the value is shown visually against a calibrated bar. The value of the bar is shown at the base of the screen. For instance, if a resistance of 12.00 K Ohms is being read, a bar of value 40K Ohms will typically be displayed, and the actual value of the resistance will show as 12.00 against that bar

Testing Continuity

1. With the 460 set for Input A (**Ch A** button), use the down arrow to set the highlight on **Beep**. Press **Enter**.
2. Connect the probes across the source to be tested. If the line is closed (equiv. of short circuit) or not offering more than 100 Ohms of resistance, the full beep will be heard, and the bar will show the degree of resistance (if any).

***Note:** The continuity test function can also be used to test the resistance in a path up to a value of 4K Ohms. The actual value will be shown alpha-numerically in the top left of the screen, and also shown graphically against a bar having a span of 0 to 4K Ohms*

Diode Test

1. With the 460 set for Input A (**Ch A** button), use the down arrow to set the highlight on DIODE. Press **Enter**.
2. Connect the probes across the diode in the +/+ direction. A total resistance should be noted (The full bar shows no reverse current flow).
3. Connect the probes to the diode in the normal +/- direction. The bar display should show an open or almost open condition. - Forward bias is shown against a scale of 2.0 volts and is also displayed alpha-numerically at top left of the screen.

Chapter 3

Operation

This chapter provides a general overview of the tpi Scope Plus 460 from an operations point of view. The keys and adapter connectors will first be identified followed by a pictorial description of the key and screen menu functions.

Principal Connectors and keys

Figure 3-1 shows the general layout of the front panel and side connectors. Many of the functions are straight forward and identified in the illustration. The numbered items in the diagram need additional explanation and are detailed below:

- 1. Ch A**

This key controls the display of oscilloscope Channel A. The first screen requires the user to first identify the nature of the display, e.g., AC Volts, DC Volts, Frequency, etc. Then, after pressing ENTER, the Channel A trace is displayed as well as the correct alphanumeric.
- 2. Ch B**

This key controls the display of oscilloscope Channel B. The first screen requires the user to first identify the nature of the display, This list is different from Channel A and includes specialized measuring scales such as °C, °F and Psi, etc. After selecting the scale, press ENTER, and the Channel B trace is displayed.
- 3. S TIME nS**

This rocker switch controls the oscilloscope timebase. Pressing the left side decreases the sweep rate in 1, 2, 5, increments down to 2-seconds per division. Pressing the right side speeds the sweep rate in increments up to 50-nano seconds per division. Sweep Rate is displayed above the TRIGGER label at the base of the screen
- 4. mV / V**

This vertically orientated rocker switch controls the vertical sensitivity for the A Channel oscilloscope. The scale is in 1, 2, 5, increments from 50mV to 200V per vertical division. The readout is at the extreme left of the display just above the A MOVE label.
- 5. mV / V**

This rocker switch is identical to Callout #4 except applicable to Channel B. The readout is at the extreme right of the display just above the B MOVE label.
- 6. Cursor Mode measurement**

This is the V_T measurement button. Pressing this button changes the

activated cursor. The user can move the activated cursor with the 4 direction keys. Each readout of V , T is displayed on menu area (Pls see Fig 3-1). Pressing the F3 key disables the cursor mode.

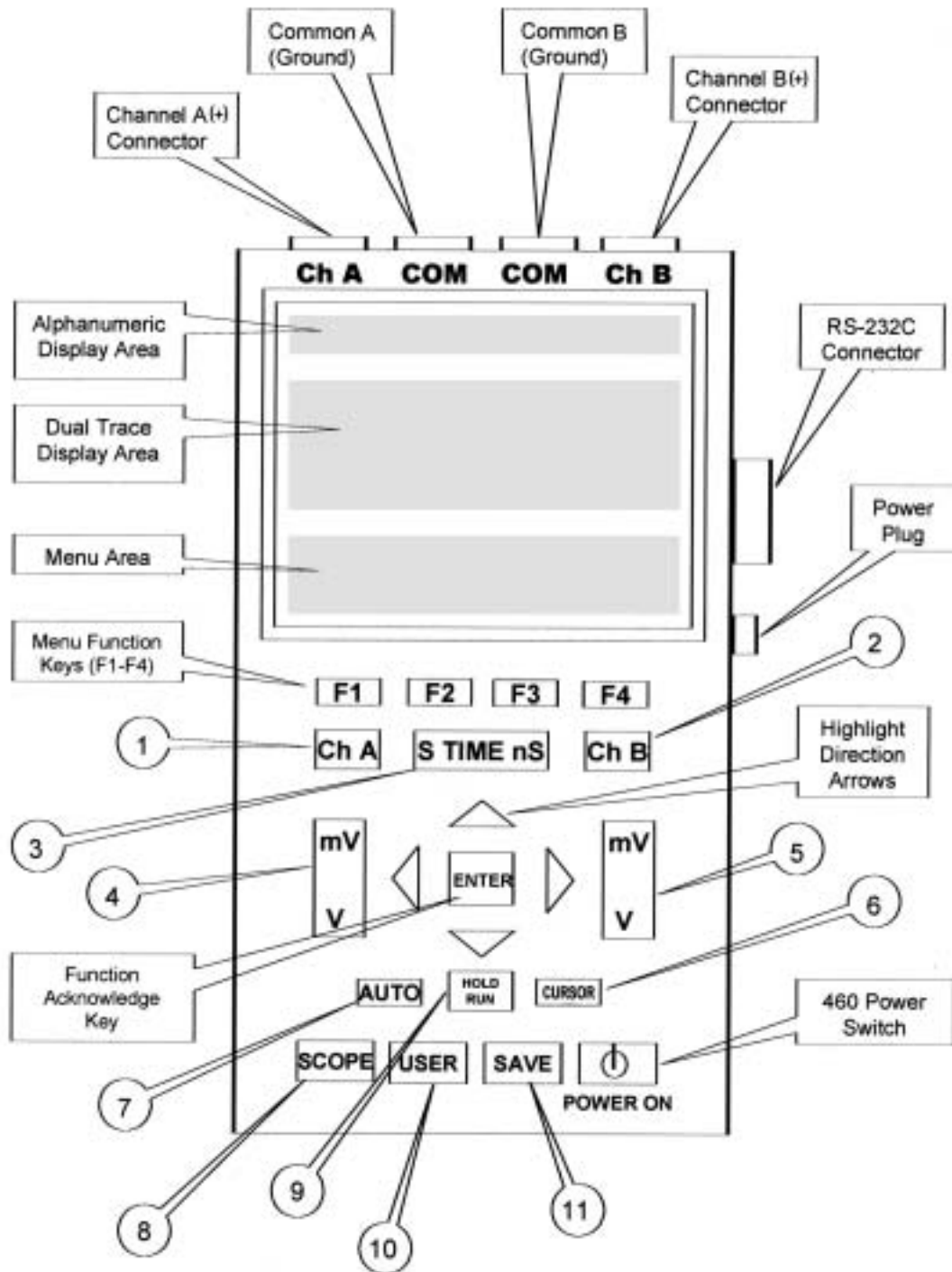

Figure 3-1. 460 Front Panel layout

- 7. AUTO**

This is the Auto Ranging and optimal setting button. In the AUTO mode, the 460 will sense the parameter being measured and automatically adjust the oscilloscope timebase to suit. The button also toggles between AUTO and MANUAL modes. Note that the previous manual settings are lost once auto mode has activated.
- 8. SCOPE**

This is a dual function oscilloscope switch. Initial activation (Scope /S1) sets the oscilloscope program to display the SCOPE INPUTS interactive menu. Activating the SCOPE switch a second time, sets the program to display the Channel A waveform, the Channel B waveform (if it is switched ON), and the A / B MOVE, TRIGGER / TREND selection menu. Pressing the switch a third time will toggle the program back to SCOPE INPUTS.
- 9. HOLD / RUN**

This is a toggle switch that allows the user to freeze the currently displayed waveforms. Once frozen, the user can choose to record the waveform using the SAVE key (see callout #11), or to press the HOLD / RUN key a second time to unfreeze the display.
- 10. USER**

This is a toggle switch that allows a user to interrupt most ongoing programs to revert to a setup mode to adjust Contrast, RS-232C output, or Power Down, and then revert to the original program by pressing the button a second time. Note that the POWER DOWN menu selection allows an automatic timed power down for special functions.
- 11. SAVE**

This is a toggle switch that allows a screen save (traces only) for a maximum of two saves and/or recalls. You can delete an existing capture, or automatically overwrite to the selected memory. Pressing the button a second time reverts to the original display.

Key / Screen Menus

The following tables provide a graphical explanation of the key and menu interactions and menu item sequencing. Most sequences begin with a key and are at the left of the diagrams. The colors of the keys are below the appropriate boxes.

Note that the two Scope entries (Scope / S1 in Table 3-1, and Scope / S2 in Table 3-2) represent the two sequential functions of the same switch.

Table 3-1. 460 User Function / Menu Interactions —Part 1

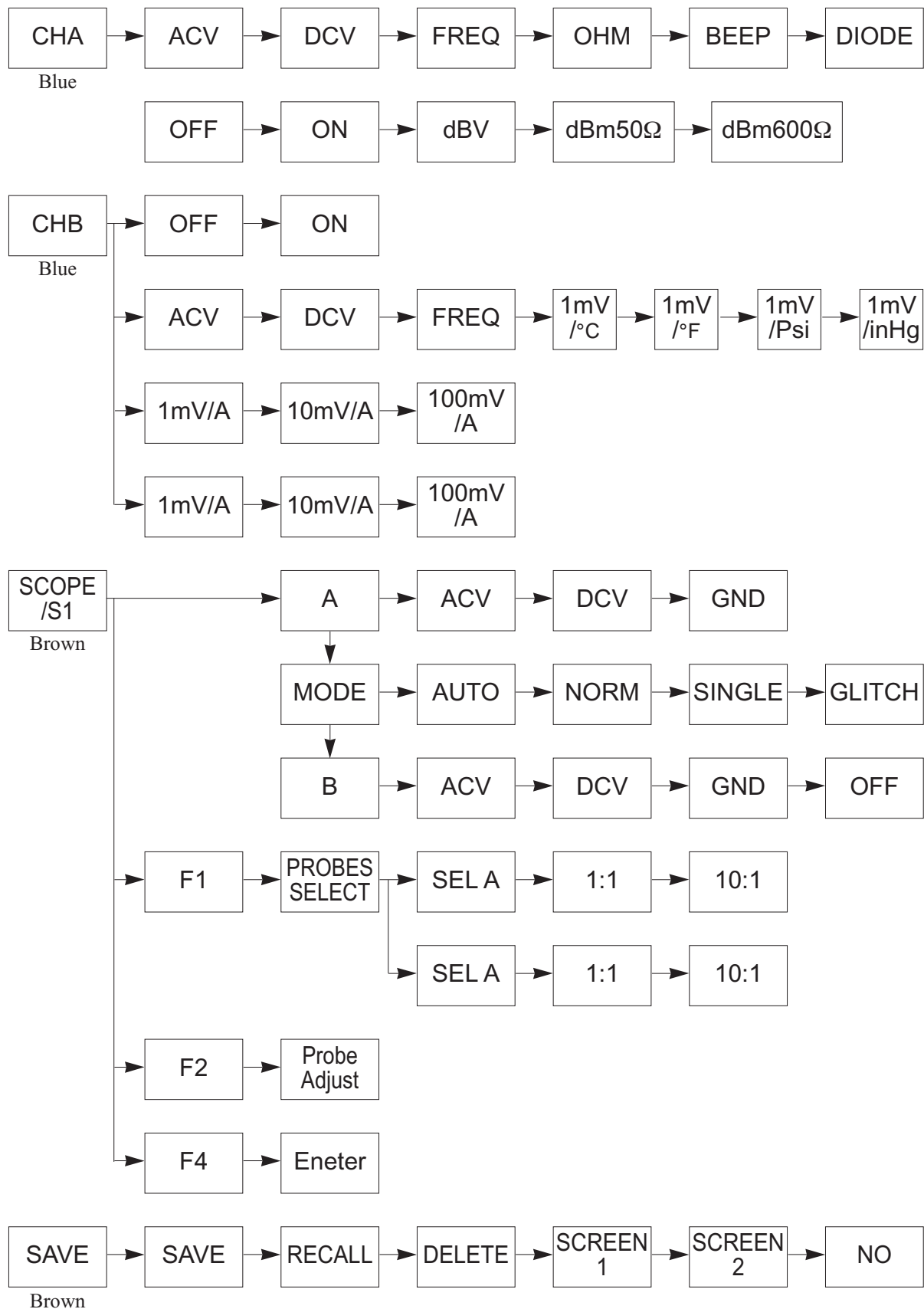
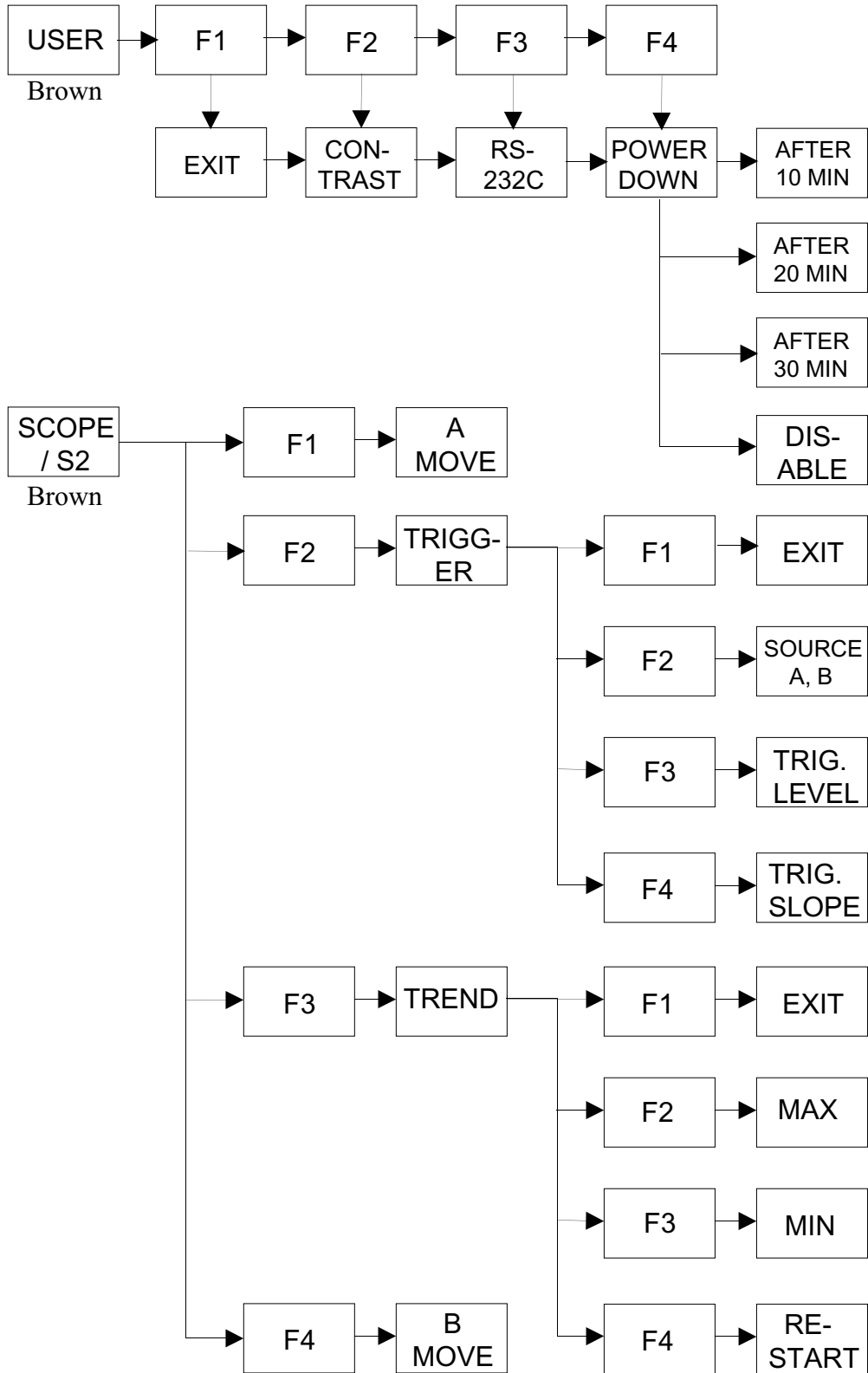

Table 3-2. 460 User Function / Menu Interactions —Part 2



Chapter 4

Advanced Functions

This chapter assumes the user has now become proficient with the general use of the tpi Scope Plus 460, and is ready to utilize the more enhanced operations of the 460's built-in oscilloscopes and related logic circuits.

In this chapter we will look at triggering, trend mode and different aspects of capturing glitches. We will also look at screen saves, use of the 10:1 probe and probe adjustments.

Triggering

Trigger level refers to the control of the threshold voltage amplitude level that is triggered from the input signal, in turn synchronizing the waveform. Once the voltage exceeds or recedes the trigger level, the meter will draw a trace of the signal with greater stability allowing the technician to analyze the portion of interest more efficiently.

With Channel A on the 460 active, connect the Common and Probe Lead A to a signal source (Sine Wave preferred), and proceed with the following steps:

1. Click **SCOPE**, then select A=ACU, Mode=Auto, B=Off. Then select **ENTER**
2. Move the highlight to **TRIGGER** and press **ENTER**
3. Use the mV / V Channel A rocker key to size the waveform.
4. With the highlight on **TRIG. LEVEL**, use the up and down keys to stabilize the waveform.
5. Observe that you have now stabilized the waveform without changing the frequency and without intentionally freezing the waveform. So this is a stabilized live waveform suitable for analysis or monitoring.
6. Use the **SOURCE** or **TRIG. SLOPE** highlight options in conjunction with the direction buttons to modify the waveform.
7. Use the **EXIT** box (F1) to Exit from the trigger operation and / or to move the waveform position on the screen.

Trend Mode

The Trend mode graphs signals over time to capture problems. This option has menu boxes but is inactive on the current model of the 460.

Glitch Capture

The tpi Scope Plus 460 incorporates this feature for capturing intermittent or single event voltage spikes occurring in a circuit. The spike is automatically detected, captured, and displayed for analysis on the screen.

To perform this task as a test, you will need a signal generator with a spike or glitch generating capability, or a means of imposing a glitch onto an otherwise stable signal.

With Channel A on the 460 active, connect the Common and Probe Lead A to a signal source (Sine Wave preferred), and proceed with the following steps:

1. Click **SCOPE**, then select A=DCU, Mode=Glitch, B=Off. Then select **ENTER**
2. Use the up and down keys to center, or lower the waveform (-the spike will usually be positive in test cases). Then introduce the spike (-this is usually a button on many test signal generators).
3. If the 460 is performing correctly, you should now have the glitch on your screen, complete with leading and trailing edges so that rise time as well as other parameters can be measured.
4. Exit the glitch condition by selecting **SCOPE**, then change **MODE = NORM**, then press **ENTER**.

Saving Screens

You can save any screen capture from Channel A, Channel B, or two instances of both channels simultaneously. They can be recalled to the screen, or made available to your computer if you also have the RS232 software option.

As an example of simultaneous capture, connect the Common and Probe Lead Ch A to one signal source, then the Probe lead Ch B to a different signal source, and proceed with the following steps:

1. Click **SCOPE**, then select A=ACU, Mode=Glitch, B=ACU. Then select **ENTER**
2. Use the up and down keys in conjunction with the A & B Move boxes at the base of the screen to position both waveforms
3. Press the **SAVE** key, select **SCREEN 1**, and then select **ENTER**

***NOTE:** There may be no change to the screen after the last operation. This is normal.*

4. Press **SAVE** again, then select the menu item **RECALL**, then **SCREEN 1**, then **ENTER**.
5. You should now see your saved waveforms with the label **RECALLED SCREEN 1**, immediately below the waveforms.

***NOTE:** The next screen save using the same screen number (e.g. Screen 1), will overwrite the previous (Screen 1) save.*

6. Select the on-screen **EXIT** to leave the Save program, then press **SCOPE** to reset the scope parameters

Using the 10:1 Probe

The TPI Scope Plus 460 is also available with selectable attenuation probes (e.g. P/N SP60B). These are usually in the form of a probe body with a 3-position switch, 1-meter co-axial lead terminating at the meter end with a BNC connector with an adapter for the 460 socket. This set-up contains its own ground lead exiting from the probe body, and is supplied with a number of different probe tips.

Attenuation selection is X1, X10, and a ground reference position. Use of the 10:1 probe extends the bandwidth to 100 MHz when used in the X10 position.

To use the 10:1 probe with the 460, press the **SCOPE** button, then the **F1** key when the **SCOPE INPUTS / PROBES SELECT** menu boxes are present on the screen.

With the 10:1 Adapter in the **CH A** socket, use the Up / Down keys to highlight **10:1** on the **SEL A** side of the displayed Probe Selection menu box. Then select **ENTER**

When using the 10:1 probe on different dual oscilloscope channels, or from instrument to instrument, always perform the adjustment procedure which follows.

***CAUTION:** Do not use the 10:1 probe for resistance measurements.*

10:1 Probe Compensation Adjustment

The following adjustment procedure will ensure that the displayed waveforms will be matched to the correct division on the display.

There are two methods to compensate the 10:1 Probe. The first and recommended way is to

connect the probe to the 460 and set up a 1 KHz square wave using an external signal generator.

Method 1

1. Connect the 10:1 Adapter BNC connector to the **Ch A** socket on the 460.
2. Press the 460 **SCOPE** key. Then, when the SCOPE INPUTS display is present, press the **F2** key below the PROBE ADJUST selection box.
3. Attach the 10:1 Probe tip to the signal generator, and use the ground wire from the probe body to connect with the signal generator ground.
4. With a square wave displayed on the 460 screen, adjust the trimmer located in the BNC plug to maximize the squareness on the top and bottom of the square wave.
5. On the 460, press the **F4** key, or the **ENTER** key to exit the program.

Method 2

1. Connect the 10:1 Probe BNC adapter to the **Ch B** input at the top of the 460. Then attach the 10:1 Probe Tip with the Banana Adapter to the **Ch A** input.
2. Press the **SCOPE** key. Then, when the SCOPE INPUTS display is present, press the **F2** key below the PROBE ADJUST selection box.
3. Following the instructions on the screen, use the screwdriver, supplied with the 10:1 Probe kit to adjust the trimmer in the BNC plug. Adjust the trimmer to obtain fully squared edges on the displayed square wave.
4. On the 460, press the **F4** key, or the **ENTER** key to exit the program.

Chapter 5

Using Adapters

This chapter covers general information on the accessories available for use with the tpi 460 Handheld Oscilloscope. For detailed information, please refer to the data sheets provided with each adapter.

Temperature Adapter - A301

This adapter is used in conjunction with K-type probes to measure a variety of temperature targets with ranges from -40 to 500°F. tpi offers almost 20 different types of thermocouple probes that work accurately with the A301.

The A301 (regardless of the type of thermocouple use, has a standard output of 1mV DC per degree Fahrenheit. The range of the A301 is -40 to 500°F, therefore the output range is 960mV to 0.5V. On the 460 this equates to using the standard DCV scale on Channel A, or the 1mV/°F scale on the B Channel (Press Ch B, make selection, and press F4 to Enter).

NOTE: *The A Channel is recommended for this adapter, as the **Ch A** plug orientation on the 460 allows the Adapter On/Off switch to face the user.*

The A301 comes with a 9V battery and a standard 2-Pin plug that sockets directly into the top of the tpi Scope Plus 460.

High Current Adapters - A251 / A256 / A296

- o A251 - A clamp-on adapter that measures up to 400 AC amps.
- o A256 - A clamp-on adapter that measures up to 400 AC and DC amps.
- o A296 - A clamp-on adapter that measures up to 1000 AC and DC amps.

All three adapters have some common operating parameters. They should only ever be used on a single wire. Clamping onto bundles or any more than one wire will result in erroneous readings.

Set up the 460 before making the test and ensure that power is initially off to the circuit under test and that the input cable is inserted using the correct polarities.

On the 460, use ACV for making AC measurements, and DCV for making DC measurements. In addition, use the V rocker button on the instrument to initially go to the highest voltage rating when making an initial measurement (200V on both scales).

All the High Current measurement adapters use a 9V battery (supplied). If the battery runs low,

the red LED will come on and remain on until it is exhausted or the battery is replaced.

Low Current Adapter - A254

This small clamp-on adapter measures currents one amp and below accompanied by voltages up to 1000V in either AC or DC.

Plug the unit into the upper sockets of the 460. Use DCV on Channel A (Ch A) and convert 10mV to 1.0 amp with the 254 set to 10mV/A and 100mV to 1.0amp with the 254 set to 100mV/A, or Channel B (Ch B) and use either the 10mV/A DCA or 100mV/A selections (depending on the appropriate A254 setting) to read both millivolts and equivalent amps at the top of the screen.

Be sure to plug the A254 into the correct sockets of the 460 for the channel being used.

***CAUTION:** This adapter is designed to measure currents up to 1 Amp. Attempts to measure currents greater than 60 Amps could damage both the adapter and the 460 measuring instrument.*

The A254 uses a 9V battery (supplied), and includes a detachable instrument head socket (2-pin to co-axial), and a zero adjust control.

Current Shunt Adapter - A130

This adapter is an inexpensive way of extending the current range of your tpi 460 Handheld Oscilloscope to 30 amps.

The A130 comes with two probes and is used in series with the circuit to be measured. The unit uses the power being measured and requires no batteries.

Plug the unit into the upper sockets of the 460. Use DCV on Channel A (Ch A) and convert 0.1mV to 0.1 amp, or Channel B (Ch B) and use the 1mV selection to read both millivolts and equivalent amps at the top of the screen.

Be sure to plug the A130 into the correct sockets of the 460 for the channel being used.

***NOTE:** Channel A is recommended for the A130 adapter, as the **Ch A** plug orientation on the 460 allows the Adapter On/Off switch to face the user.*

Pressure Adapter - A620

This adapter can measure air densities from a vacuum of 30 inHg to a pressure of 500 psi.

Connect the adapter to the upper sockets of the 460. Use **DCV** on Channel A (**Ch A**) and convert 0.1mV to 1 psi for pressure and 1 inHg for vacuum, or Channel B (**Ch B**) using the 1mV/PSI or

1mV/inHg selections as required.

On the A620, use the **BAR** switch position to measure vacuum or the X10psi position to measure pressures from 1 to 500psi. Use the **ZERO** control only if you know the pressure to be zero and stable, or at a standardized pressure.

The A620 uses a 9V battery (supplied) and includes a 1/4 inch NPT pressure port connection at the end of a 2-Meter flexible cable.

PC Software and RS232 Cable - A404

This software allows the 460 to download data and waveforms to any computer environment running Microsoft Windows. The RS232 interface utilizes a fiber optic connection to shield the data from electro magnetic radiation sources, and therefore from potential signal degradation.

Using the A404 package you can download data and put the information into spreadsheets and charts for incorporating into reports and other documents. Reports from different units can also be merged to produce one report.

In addition, graphs can be shown with the identification number of the instrument used, enabling data to be cross-checked against calibration records helping to ensure full traceability.

Since live waveforms can also be transmitted to the computer via the RS232 connection, you can compare stored waveforms to current waveforms for some types of fault recognition.

Refer to Appendix D for RS232 interactions with your personal computer.

Chapter 6

Safety Considerations

This chapter deals with various aspects of safety, both for personnel and the instrument. Also included is a List of safety signals and their meanings.

Instrument Cautions

o Test the Instrument before using

- o Check Backlighting and Contrast (this will also accomplish a quick test on the battery level).
- o Check both oscilloscope channels. - A simple standard waveform test will usually accomplish this.

Check the Test Leads and/or Adapter

- o If there is a break or intermittent in the test leads, it will have the same effect as a malfunctioning instrument.
- o Check the adapter using a known sample or set-up before using on the device or environment under test.

o Test Connections

- o Check the security and quality of both the adapter connections to the instrument and DUT (Device Under Test) connector points.

Disconnect Power to the Circuit (Unless using Clamp-On's)

- o This step provides two safety factors. The first ensures that the operators hands are not in the vicinity of dangerous voltages. The second allows you to check that the instrument is set up to read the right values before power is present at the DUT.

o Understand the circuit being measured

- o Failure to understand the circuit to be tested has the same level of risk as not setting up the instrument before power is applied to the circuit. Namely the risk of too much power for the level of measurement.

Keep the Instrument Non-Parallel to the Circuit

- o If the instrument, or any substantial length of test cable is parallel to and/or in close proximity to the bulk of the DUT or high current carrying cable, the test cable will pick up some of the radiation and be affected by it. This is important when making precise measurements or when seeking a stable waveform.

Personnel/Environmental Factors / Warnings

Assign a Checker

- o Arrange to have someone check on you periodically. This is especially true of high voltage environments. An unconscious worker stands a better chance of survival if resuscitation is given in the shortest time after an accident.

Do not attempt to measure unknown voltages or currents

- o With modern cabling, it is easy to assume that a small size wire or cable is carrying a voltage or current that is less than actual. Either assumption can have disastrous effects for both operator and instrument.

Do not touch any exposed part of the test lead assembly

- o Some types of test leads have close to exposed metal parts that could potentially come into contact with the body, especially hands or lead pencils and other conducting items.

List of Danger/Warning Signals

The following are International Danger/Warning signals with an abbreviated explanation of their meanings.



This label signifies that there is a distinct level of danger in this area. This sign is usually accompanied with symbols denoting the exact type of danger present.



This combination label signifies that a significant level of danger exists in this area that can effect the eyes. This symbol denotes that shaded goggles should be worn.



This combination label signifies that there is a distinct possibility of a fire hazard in this area (--an explosion symbol is sometimes substituted for the fire symbol in similar situations). Do not carry combustible materials in this area



This combination label signifies that there is a strong possibility of electrical shock in this area. Proper attire, and especially insulated footwear are required in these areas.



This International symbol signifies that conditions exist that could result in bodily harm. The symbol usually occurs in conjunction with a symbolic description of the type of hazard that exists.



This symbol indicates that there are open gears in the area which could snag clothing and risk injury to the wearer. Avoid wearing loose clothing and beware of test instrumentation with long leads attached.



This symbol indicates that a hazard exists in this area which could effect exposed skin areas. The nature of this hazard could be chemical or temperature based. Wear gloves at all times and be careful of any other skin contact.



This International symbol indicates that a danger exists which could damage equipment that you carry into the area. Identify proper grounding and use in conjunction with test equipment at all times

Appendix A

Test and Calibration

This chapter is designed to re-affirm that your TPI Scope Plus 460 is functioning correctly and is on a par with the original calibration. This test and calibration procedure can be used as an annual test, goods inward (Acceptance) test, or re-affirmation test when readings have not been expected ones.

Test Procedures

The TPI Scope Plus 460 has no built-in test programs, however, the following procedures can be used to perform a quick functional check on most 460 operations. Procedural titles that are followed by an asterisk (*) are less important, and can be considered optional in cases where a quicker spot test is required.

Initial Setup

The following tests should be made with an adequate battery charge and with the power charge plug in place, and the RS232 cable disconnected. If the battery has previously been low, allow at least 15-minutes for the battery charge to build up.

On power up (press and briefly hold the **POWER ON** button), allow a further 5-minutes for the circuitry, and LCD screen to stabilize. After stabilization, press **USER**, then **F2** to arrive at **CONTRAST**. Press **ENTER**, and use the Up / Down keys to adjust for optimal contrast. One way to do this is to press the Up arrow until the background begins to darken and then backtrack down by pressing the down arrow once. In any case , the waveform and alphanumeric characters should both be black and stand out in strong contrast to the background

Check the brightness by pressing the blue button with the Sun icon. Continue pressing. After 10-counts, it should resume to maximum brightness.

If any of the above steps perform unsatisfactorily, you either have an undercharged battery, or a malfunctioning LCD display. Check with the service department (see phone numbers on Page 1 of this document), before returning the unit.

Sequencing Test

This test will verify that the internal multiplexors are correctly sequencing information to the display. Note that much of the sequence is dependent on the previous display, so many of these steps will not work when separated from the overall context.

1. Press the **USER** key. The following menu bar should display at the base of the screen:

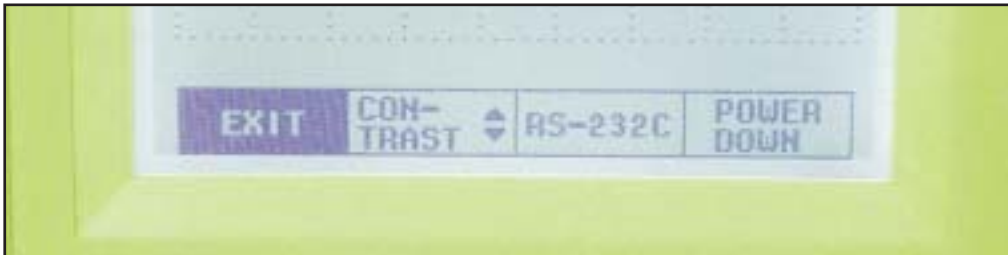

2. In the previous screen, use **CONTRAST** to make any necessary adjustment, then press the **SCOPE** key. The following menu should display:

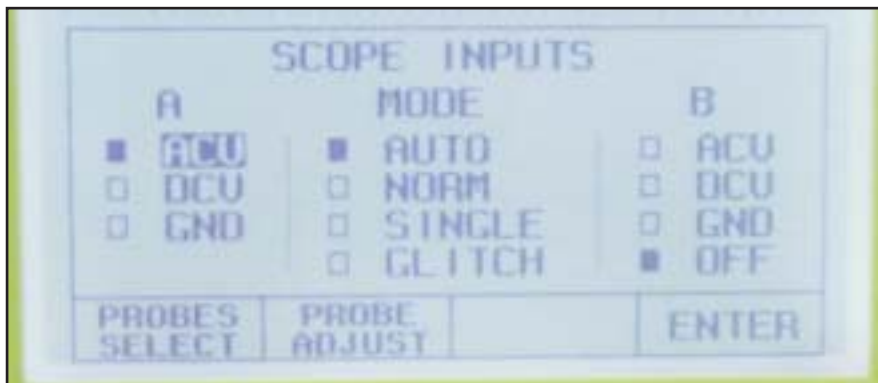

3. Press the **F1** key. The following menu should display.

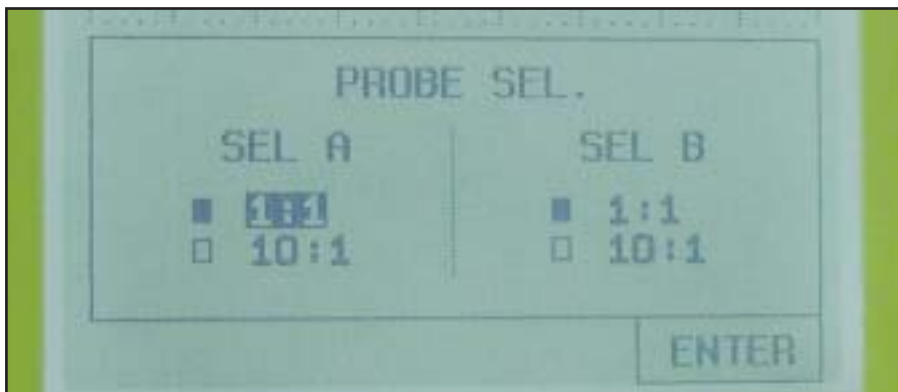

- 4. Press **SCOPE**, then **F2** (PROBE ADJUST). the following display should result.

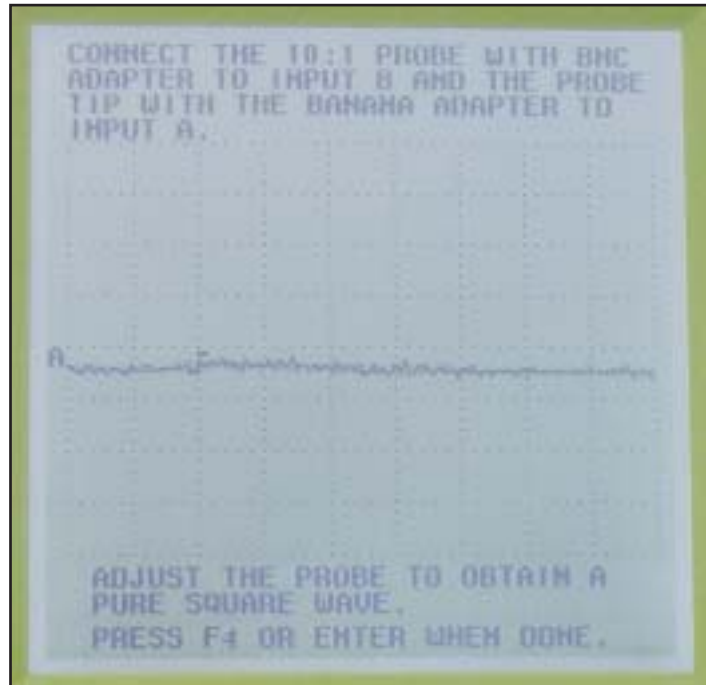

- 5. Press **ENTER** to leave the PROBE ADJUST display, then complete the Scope input using the **ENTER** button and Direction keys. Then press **Ch A, ACV**, then **F3** (TREND). You should get the following menu display:

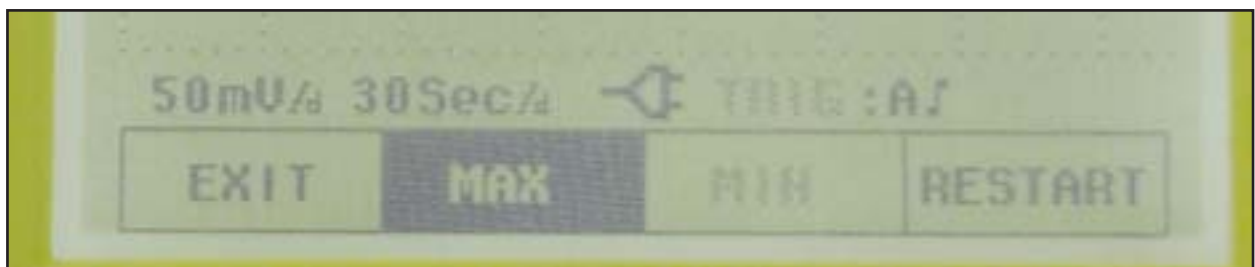

- 6. Repeat the sequence for Step 6, except in the last step, press **F2** (TRIGGER), instead of **F3**. Follow by pressing **ENTER** -You should get the following menu display.



7. Press **F1** (EXIT) to leave the Trigger menu, then **ENTER**. Now press **Ch B**. The following menu should result.

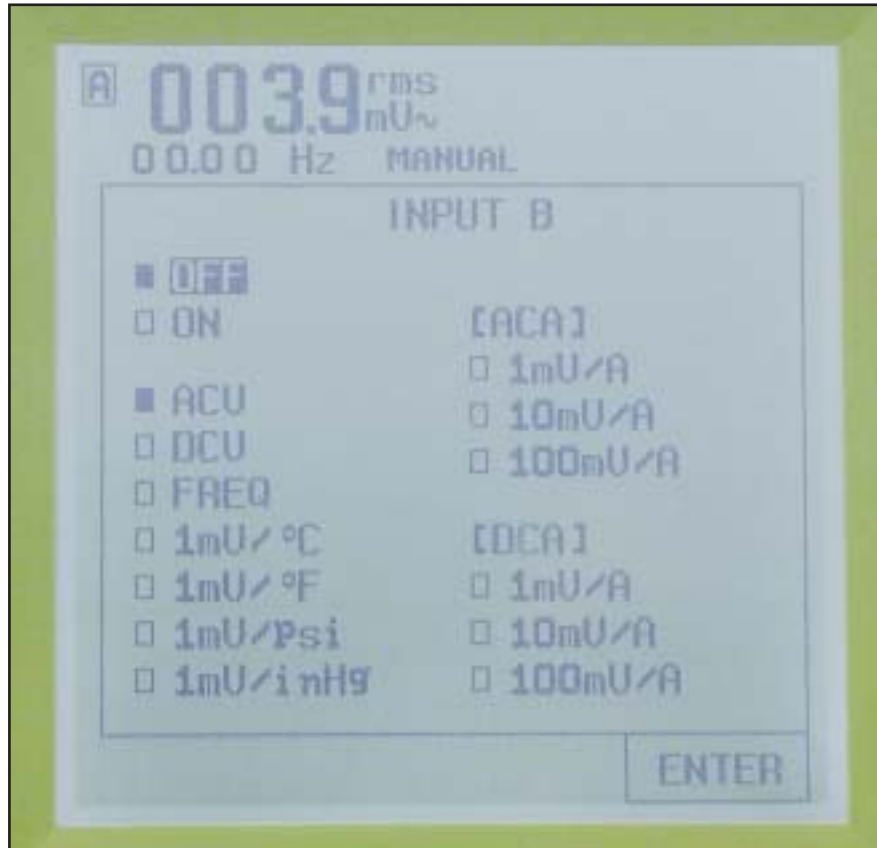

8. The previous screen shows the Channel B available selections. Click through the sequence until you get to 1mV/Psi. Then finish the other selections and click **ENTER**. - Check that the display shows Psi units at the top left of the screen. This is a spot check on the sequence of one of the lists in this menu. You may choose to do this for the other lists too (i.e.:ACA, DCA, etc.).
9. Press **ENTER** to exit with your selections from the previous screen, the press **Ch A**. The result should show the selections available specific to Channel A, as depicted in the following screen.

dB measurement is available on ACV and DCV only.

$dBV = 20 \log |V|$, $odBm = 1mw$

The result is displayed with the unit on alphanumeric display area of Figure 3-1.

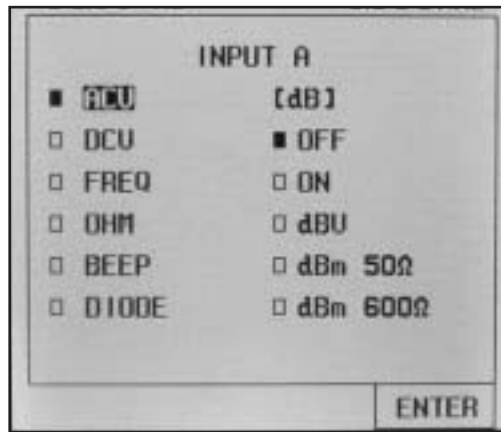

10. Use the direction arrows to move down the menu to BEEP. Select **F4** to acknowledge selection. The following screen display should result.

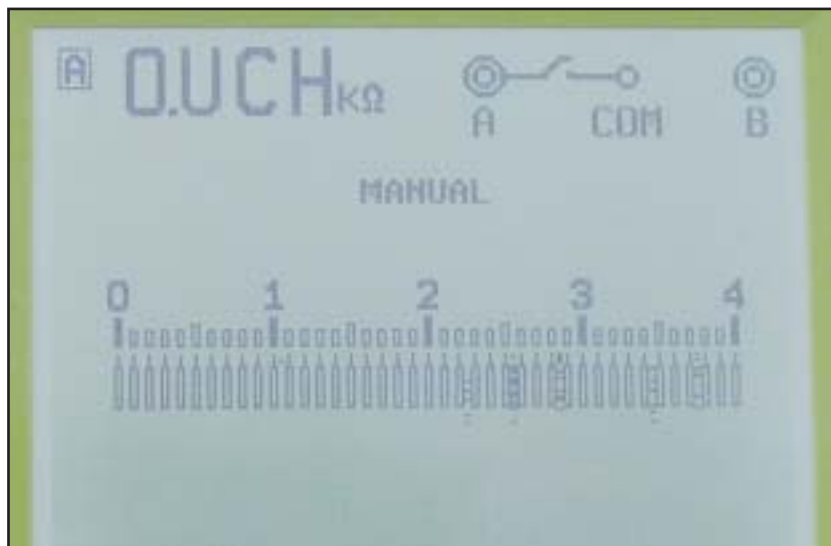

11. Press **CH A** to return to the original Channel A menu, except this time use the direction keys to move down to the DIODE selection. Press the **F4** key to acknowledge selection. The following display should result.

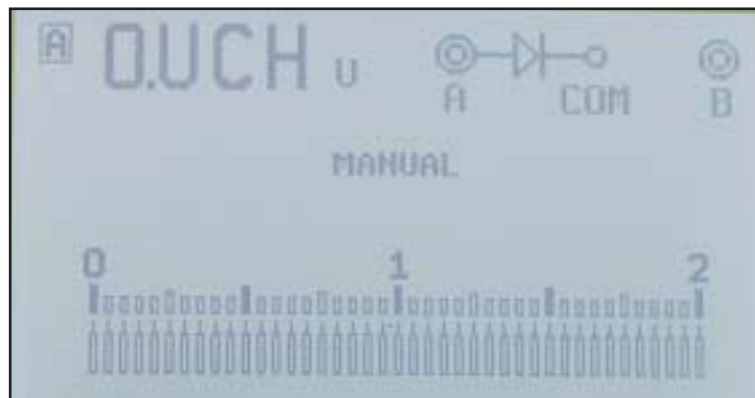

12. Press the **Ch B** key, then **F4** to acknowledge exiting the Diode Test mode. Select **Ch B** a second time to bring the selection options up to the top of the menu. Then in the Channel B menu, select **ON**, **ENTER**, **ACV**, **ENTER**. You should now have a dual trace display. Press the **SAVE** key. This should give you the following menu selection.

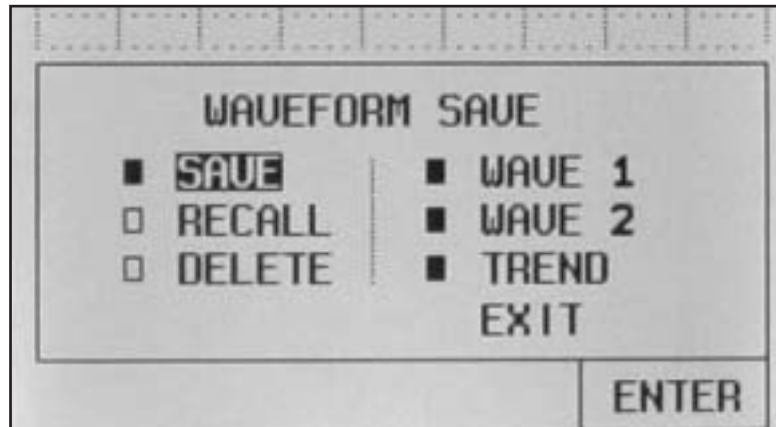

13. In the waveform save menu, select **SAVE**, **F4** (ENTER), then **WAVE 1**, **F4**. This will save the first of the two possible saves in internal memory. Now repeat the waveform save function (**SAVE** key), except choose **RECALL**, **F4**, **WAVE 1**, **F4**. A screen similar to the following should result:

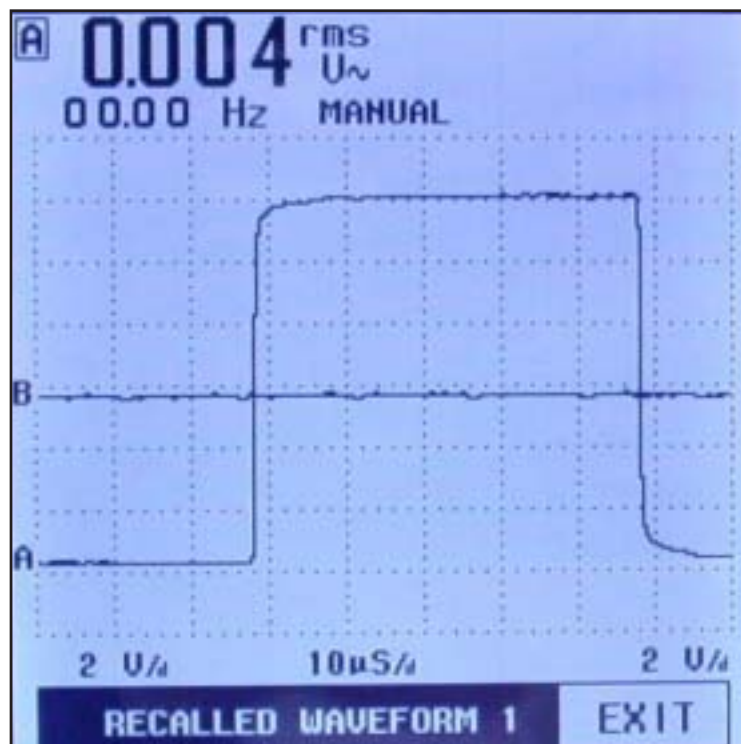

- 14. Press the **Ch B** key. Select **ON** and **ACV**, then press **F4** (ENTER) to enter the command. You should get the following screen.

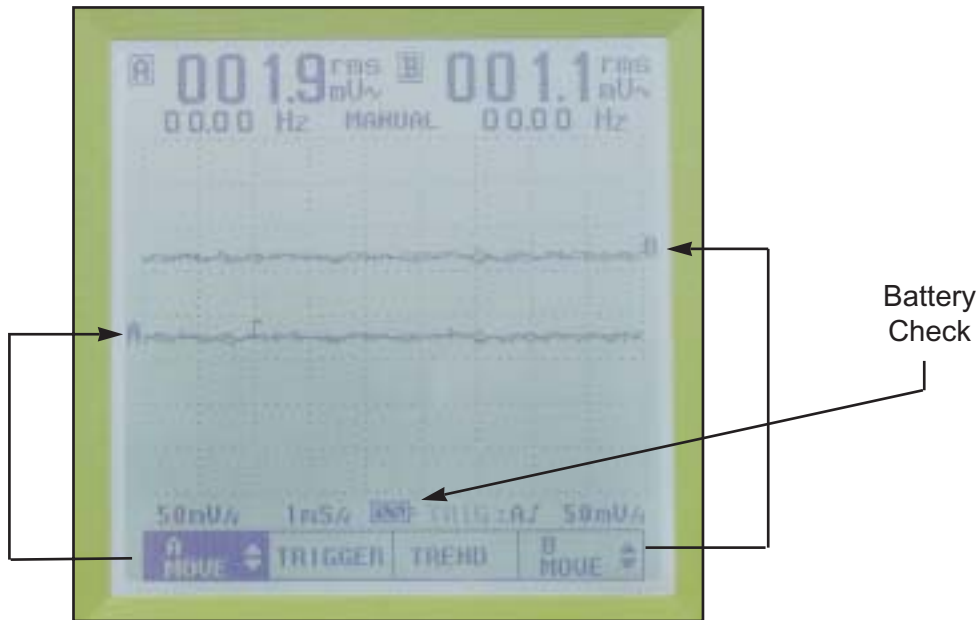

- 15. In the screen shown above, use the keys **F1** and **F4** to separate and position the two traces from Channel A and Channel B in conjunction with the Up and Down arrow buttons. Also note the Battery symbol in this depiction. The bars of the battery will blink when the battery starts to get low. The battery symbol is replaced with a power plug symbol whenever the power cord is attached.
- 16. Press the **USER** button, then **F3** (RS-232C). Press the **ENTER** button. You should get the following screen menu:



17. Select the correct baud rate for your computer and press **F4** (ENTER). Refer to Appendix D for other RS-232 interface details.
18. While still in the USER / CONTRAST Menu, select **F4** to activate the **POWER DOWN** menu. Then press **ENTER**. The resulting display should be similar to the following one:



19. Use the Up/Down arrow buttons to select 10-Mins, then press **F4** to enter command. Note the local time that the unit should switch off. If the unit switches off at any other time, then the internal sequencer is incorrectly set and will need to be adjusted. Note that you can continue to use the 460 in any way you choose up until it automatically powers down.
20. This is the end of the general sequence test. If any problems were found with sequencing, other column type lists that were not included should also be checked. For general operational tests, refer to Chapters 2 and 4.

Calibration

Most calibration adjustments are carried out at the service facility or factory, however the following tests and adjustments can be made in the field. If you established that the instrument or attachments are out of alignment and/or are not measuring within the confines of the specifications, call your local service representative or the number at the front of this manual for the correct address to return your parts to for test and calibration.

- Always use a known or reliable standard when making a test measurement. For instance, when testing a resistance scale, use only high tolerance parts. E.g.: +/- 1%
- Check that the accessories such as test leads are the correct type for the entity being measured (some test leads have their own specifications and are usually supplied with the product).

- Make sure that both the instrument and test leads are not close or parallel to electromagnetic sources which could be picked up by the 460 and/or the leads and which could effect readings.
- Be sure that the ground (Common) for the entity being measured is the true ground.
- Check the specifications in Chapter 1 for the scale being measured
- Note that probes which are internally attenuated, usually have their own adjustment procedure. Chapter 4 has an adjustment procedure for 10:1 probes.

Appendix B

Maintenance

This chapter covers basic maintenance for the hand-held TPI Scope Plus 460. These procedures include general inspection, use and inspection of probes, and battery check and replacement. Note that attempts to perform maintenance beyond the scope of this document, especially alterations to interior settings, may result in a default of your warranty coverage.

General Inspection

The following steps are recommended, but the sequence is not critical. If all steps are performed, and the instrument is malfunctioning, note the conditions on a label and attach it to the instrument. Prepare the unit for mailing in to the address given at the front of this document, but please call the service department before shipment.

1. Check the exterior of the instrument for damage and existence and functionality of the carrying handle and back support flap.
2. Check the back of the instrument for any loose or missing screws, and any obvious interior rattles. Note: Do not shake the instrument vigorously. A gentle rocking is sufficient to check for loose parts.
3. Check the display face plate for nicks and scratches that could cause interference with viewing waveforms.
4. Check the plug sockets at the top of the instrument for discoloration or burns, etc.
5. Check the key markings and silk screening above the display (Ch A / COM / Ch B), for readability.
6. Connect the power adapter to the 460, and allow 10-minutes for the circuitry to stabilize. Then press USER > CONTRAST and use the arrow keys and sun icon button to adjust for optimal brightness and contrast. If the brightness and/or contrast are slightly out, the internal battery may be undercharged. If the unit has been in service for a long time and the display is very dim, you may need to replace the battery (see instructions on battery checks and replacement later in this chapter).

Probes

The 460 comes with one set of probes and can be used with a number of other probes available as optional extras. Most of the probes come with their own specifications and instructions, so only general maintenance information will be included here. Please note the following points.

1. The bandwidth of the 460 is 20 Mhz. Not all probes have this much bandwidth. If you use probes with lesser bandwidth, the measurements and waveform interpretation may be inaccurate. Check the specifications of the probes you receive before using them.
2. The ground potential in the shield of most co-axial type probes is the same potential as the "Common" potential. This means that if you use the convenience ground outlet in the body of many probes, it will have the same effect as using a separate wire from the "COM" outlet of the 460.
3. The normal attenuation in probes is, for all practical purposes zero, these are the probes referred to as 1:1 probes. Another commonly used probe is the 10:1 probe. The 10:1 probe is attenuated (sometimes switchable) to read only one tenth (1/10th) of the potential that the probes detect at the probe tips. The 460 has an internal ability to read 10:1 probes correctly, as long as the instrument is correctly set (SCOPE > F1 > 10:1 > ENTER) . Note that you can set up the two channels of the 460 for different probe sensitivities.
4. The 10:1 probe requires a minor adjustment (because of the internal attenuation circuit) whenever you set the probe up, or use the same probe on a different channel. This adjustment is so that the displayed waveform will accurately represent the shape of the waveform being measured. The adjustment is usually made via a trimmer (variable capacitance) in the head of the adapter at the instrument end. Refer to Chapter 4 (10:1 Probe Compensation Adjustment), for instructions on making the adjustment.

Battery Check and Replacement

The 460 uses a rechargeable 4.8V Ni-MH battery (4-cells @ 1.2V, 3Ah). The battery should last through many recharges before losing the capacity to hold a charge. Should the latter case happen, the best option is to replace the battery. The following steps will guide you through this process.

Disassembly:

1. Disconnect the power charging plug and all connectors and cables. Then check that power for the instrument is off. If the battery compartment cover is hot, you may wish to let the instrument cool before performing the next step.
2. At the back of the instrument, remove the two screws near the base of the support flap.
3. Turn the instrument over so that the battery cover and battery fall into the palm of your lowest hand. If they do not come out on their own, give a slight up and down shake to the instrument. However do not use excessive force.

4. Reverse the instrument again, so that you can see the battery connections entering the instrument. Gently pull the leads back and downwards so that the plug releases without catching onto the inside of the case.
5. Note the battery type that you have just removed as a double check with the type you are going to replace it with.
6. If you are going to dispose of the old battery, mark it for proper disposal. Ni-MH batteries should not be incinerated in standard incinerators or crushed.

Assembly

1. The 460 uses a TPI A006 replacement 4.8V rechargeable Ni-MH battery. Unpack and check the battery type and the existence of a 4-pin plug on the end of the leads. The battery comes uncharged and will need to be fully charged after installation.
2. Refer to Figure B-3 and install the connector into the battery compartment socket. Note that the red leads are to the right of the connector. The leading edge of the connector is best inserted slightly upward and forward.
3. Refer to Figures B-2 and B-3, and install the battery into the compartment, connector end first. Fold the wires in a single fold to the left, keeping the wires at the top of the compartment.
4. Check the wires are inside the perimeter of the battery case housing and replace the lid above the battery. Insert slight pressure on the lid to determine if the wires are properly folded inside. Insert the two screws and tighten down without using excessive force.
5. Turn the unit over and insert the power charging plug. Set the instrument aside to fully charge. --Typically 12-hours for the initial charge.
6. Refer to Chapter 2 and perform the 460 setup with special emphasis on setting up the initial contrast setting. Note that even after fully charging the batteries, a low contrast setting may make the screen difficult to read until adjusted.

Use single loop U configuration between connector and battery outlet.

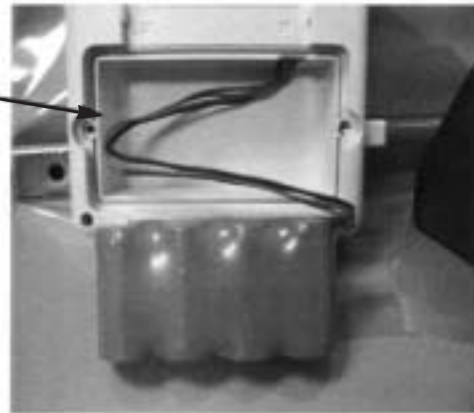
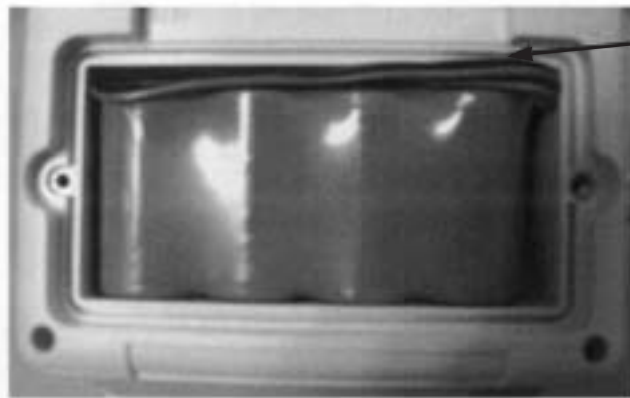

Fig. B-1. Pre-install Battery Wire position



Fold wire within confines of inner battery compartment

Fig. B-2 Battery Wire position after installation

Note topside position of guide bar, and location of red wires to right side.

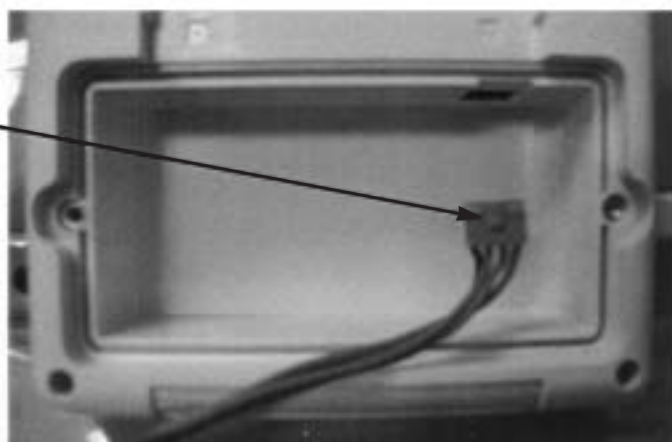

Fig. B-3. Battery Connector position before insertion.

Appendix C

Glossary

The following terms are pertinent to the TPI Scope Plus 460 and the environment in which it typically works. The meanings in other environments may be different to those described here. Cross references in this glossary are identified with an asterisk (*).

Active Power	A power measurement in Watts that is derived by multiplying the voltage portion of the signal by the current that is in phase with that voltage.
Analog Output	A non-digitized signal such as those used to drive an oscilloscope.
Apparent Power	The product of the voltage applied times the current flow. The unit of measure is VA (Voltamperes), and the term is only applicable to Alternating Current (AC) circuits.
Auto Hold	The action by a measuring device to (on command) wait until a reading has stabilized before storing that reading and making it available for display.
Auto Ranging	Ability of a measuring device to automatically select the appropriate range of measurement.
Auto Set	A command to the measuring device (AUTO on the 460) to go from manual to automatic setting based on the magnitude of the signal being measured.
Bandwidth	The frequency range over which the instrument operates efficiently.
CCFL	Acronym for Cold Cathode Fluorescent Lighting. -- The type of backlighting used in several tpi instrument displays to light the back of the LCD* screens.
Cold Junction Compensation	A circuit in a measuring device which automatically resolves the difference between an ambient reference (used when the device was calibrated), and the actual operating temperature of of the measuring device.
Conductance	The reciprocal of resistance expressed in terms of Siemans (formally mhos).

Contrast	The level difference between light and dark.
Continuity Beeper	Audible tone emitted from a meter when the resistance falls below a preset threshold value (typically 100 Ohms).
Cosine F	Voltage and Current do not always happen together, often there is a difference. The difference is an angle between 0 and 90, termed F. The greater e angle, the bigger the difference between True and Apparent Power and the smaller the Power Factor. If Voltage and Current happen at about he same time, F is small, the values of True and Apparent Power are close, Power Factor approaches 1.
Criterion Sound Level Level	The eight hour average weighted sound level, expressed in dB, that corresponds to the maximum permitted daily exposure to noise as prescribed in national and state regulations.
Data Acquisition	The ability of an instrument to acquire measurement information as it occurs, and to be able to store it, for future retrieval or transmission.
Data Logging	Typically, the ability of an instrument to store information in non volatile memory for use later (on demand) for analysis and report generation.
Data Hold	The temporary storage function of a measuring device which holds a displayed value when a user presses a key or button.
Decibels	The unit of measure expressed as dB's, used when measuring the level of sound. Every 3dB represents approximately double the power or sound level, hence 53dB is twice as loud as 50dB. dBm refers to decibels above one milliwatt.
Differential	In dual input measuring devices, differential is the displayed difference between the two inputs (Input A - Input B = Differential).
Diode Check	A function of a measuring device in analyzing the operation of a diode. The probe leads are attached to either side of the diode and the user is alerted visually and/or audibly as to the diode's integrity.
Display Counts	The number of display units a meter or other device can indicate. For example, a 3-1/2 digit display can indicate from 0 - 1,999 and a 4-1/2 digit display can indicate from 0 - 19,999. If a meter is bi-polar it can indicate positive and negative depending on the

	polarity of the signal being monitored
Duty Cycle	The ratio of the working time to the total time of a pulse train expressed as a percent.
Elapsed Time	The period of time between the start of a measurement series to the last measurement observed or recorded.
Electric Power	The measure of electric energy whose unit is the Watt. E.g.: 1 Horsepower = 746 Watts. It is derived by multiplying the applied voltage by the current passing through the circuit
Emissivity	A term related to temperature measurement using Infrared radiation. Errors in IR measurements can occur based on the color, shape, and presence of reflection on the measurement surface. A wide emissivity adjustment should be available on a IR thermometer to allow the user to compensate for these types of errors.
EMF/Electromagnetic Radiation	Waves generated by a magnet configuration usually consisting of a coil wound around a steel core. The core is strongly magnetized when current flows through the coil. Video Monitors, power lines, and wire harnesses are a few of the devices which produce electromagnetic radiation.
Glitch Capture	The ability of an instrument to listen for and capture spikes that occur in signals. The resulting captures are usually sent directly to the screen for display.
Go/No Go Alarm	An output from a meter or controller which is used to indicate when a preset measurement point has been reached or exceeded. On the tpi 460, the continuity checker is a form of Go/No Go alarm
Kelvin Connection	A four wire method of connecting test leads which is designed to eliminate or greatly reduce the effect of lead and contact resistance and thus permitting accurate measurements of low resistance.
LCD	Acronym for Liquid Crystal Display. Liquid crystal is a liquid that is not isotropic, that is, it forms patterns when polarized. The orientation of the molecules of the liquid are arranged by the meter to form the display.
LED	Acronym for Light Emitting Diode. An electric current is passed through the diode causing illumination. When used for alpha-numeric display purposes, the LED's usually have seven segments

per digit Orange, yellow and Green are common LED colors.

Load	A device that is driven by the output of a meter or other measuring or control equipment. An example of a load is a resistor being measured by a multimeter. The resistor “loads” the meter since it becomes part of the measuring circuit.
Microprocessor	Integrated circuits which perform many instructions per second for functions such as mathematical equations, data storage, display updates, etc. Microprocessors are at the heart of computer accuracy, repeatability and speed. Also called CPU's (Central Processing Units).
Min/Max	A function of a measuring device which records (saves) the highest and lowest reading it has encountered since being reset (cleared) or powered up.
Multiplexer	A device that sequences access to a communication port. Several different devices can share a single COM port on a computer if they are multiplexed.
Overload	A signal that is greater than that which a measuring device can accurately or safely accept. Many meters have overload protection in the form of a fuse, or similar device, to protect the meter from overload input.
Over Range Indication	Visual display alerting the user that the signal present at the meter's input is out of range.
Peak Hold	The ability of a measuring device to hold the highest reading until the user clears the display. Also known as Peak Detect.
Relative Mode	Displays the difference between the measured value and the stored value.
Relative % Mode	Displays measured value as a percentage of stored value for checking component tolerances.
Power Factor	This is the ratio of Watts to VA, or True Power* divided by Apparent Power. This can be expressed as a decimal or percentage, i.e. : PF=0.65 or PF=65%. True Power is never greater than Apparent Power, so the Power Factor is never greater than 1. Power Factor may also be expressed as Cosine F*
Probe Select	Most probes are only mechanically different. However when they

differ electrically they will effect metering. The most common electrical difference is a change in attenuation. tpi probes typically come with attenuations of either 1:1 or 10:1.

Probe Adjust	For the meter to read accurately, the DUT and input capacitances should match. Probe adjust allows a capacitance compensation to be made whenever a change of probes or oscilloscope input is made.
Psychrometers (Wet Bulb)	A relative humidity measuring device which has two thermometers. One of the thermometers measures ambient temperature (dry bulb), the second measures the temperature of an element surrounded by a fibrous material saturated with water (wet bulb). Reference tables are than used to determine relative humidity.
Real Time Update	The tracking of events as they happen.
Recall Mode	To bring back from memory and display a previously recorded waveform.
Resolution	The smallest value a display device can indicate. For example, if a device can display 0.0 to 100.0 RPM, the smallest measurement, and therefore the resolution, is 0.1 RPM
Response Time	The rate at which a measuring device responds to a change in the measured variable
RH Capacitance Probe	A capacitive device that senses relative humidity The meter used with such a probe senses the change in capacitance based on the moisture encountered by the capacitor's dielectric and displays the relative humidity based on this capacitance value.
RH Resistance Probe	A resistive device that senses relative humidity The meter used with such a device monitors the resistance of the probe which changes proportionally to the amount of moisture encountered. The meter then displays the relative humidity based on this resistive value.
RMS	See "True RMS"
RTD	A temperature measurement device whose resistance is proportional to temperature.
Single Phase	A single alternating current source such as a typical AC wall outlet. Three-phase on the other hand, provides three separate alternating

signals.

Thermistor	A resistive temperature measurement device whose resistance decreases as the temperature increases. A thermistor is a stable, compact and rugged two terminal ceramic-like semiconductor bead.
Thermocouple	A 2-wire temperature measurement sensor constructed of two dissimilar metals which form a junction. Current flows from one metal to the other in proportion to temperature. A millivolt signal is then measured by a thermometer or other display device temperature.
Threshold	Sound levels below this point (also called Threshold Cutoff), are excluded from dosimeter measurements. National and state regulations determine the threshold level.
Transistor Test	A function of a measuring device which can be used to check the operation of a transistor. The leads of a transistor are inserted into a receptacle and the meter indicates whether the device is operational or not.
Trend Mode	The function of graphing signals over time to capture problems.
Trigger Selection	The basis and point at which the oscilloscope begins its tracking. Usually selected on the basis of AC, DC, or Glitch Capture, with slope edge, level, and sensitivity selectable.
True Power	Electric power, measured in Watts.
True RMS Voltmeter	A Voltmeter that measures an AC sine wave (voltage and current) and displays the root mean square (rms) of each waveform cycle. Important when measuring true power, and on the non-sinusoidal waveforms found in many circuits and controls.
Watt	The unit of measure for electric power. 1-Horsepower = 746 Watts.
Zero Adjust	Ability of a meter to be calibrated to a null or "zero" reference ensuring accurate readings in all ranges.

Appendix D

RS - 232C / PC Interface (Optional)

The RS-232C / PC Interface is a powerful tool for downloading instrument data, especially waveforms to your PC for subsequent program integration. In addition you are able to view your waveforms on a larger scale, on a clearer grid and in a color of your choice. This appendix is divided into the following sub-sections:

- **Installation**
- **Set-Up**
- **File Management**
- **Print Management**
- **Controlling the A460 from the PC**
- **Archiving**
- **Special Applications**

Installation

The RS-232C package comes with an optically isolated RS-232C connector/cable assembly to fit the standard 9-Pin RS-232C Communication Port (Com Port) on your PC, and two 3-1/2 diskettes for the software. Use the following procedure for initial installation into any PC running in a Windows environment.

1. Connect the 2-pin optical end of the cable assembly into the side socket of the 460. Connect the other end to the Com Port of the PC. Tighten the screw of the Com Port plug.
2. Insert the first software installation disk, and use the mouse to select Start -> Run. Enter A:\SETUP.EXE into the Open box and select OK. Repeat for the second installation disk. You should have a screen similar to the one shown in Figure D-1

Set-Up

After software installation, you will have the display but not necessarily the trace and other data capture information. Use the following steps to bring up the data:

1. Set up the active display colors by selecting Color Set Up in the Printer section of the display. Select the color box next to Background. In the resulting display, select a box or color band and then click OK. Repeat for Grid and Graph, then click OK to exit from the Graph box.

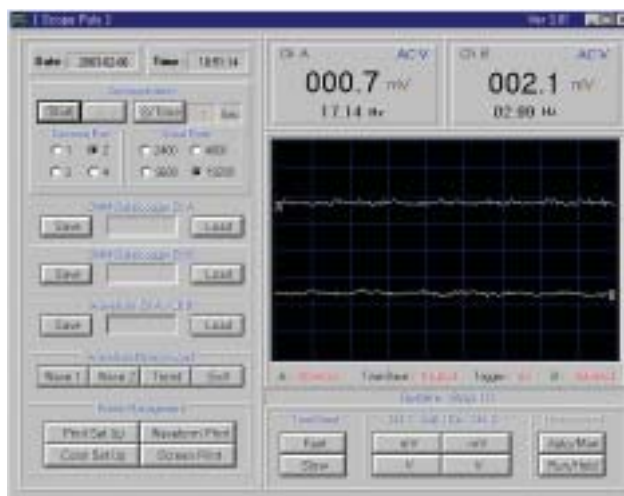

Figure D-1. Basic 460 RS-232C display

2. If you want to logging for CHA/CHB DMM data, Assign a save identifier for both channels. To do this, select the **Save** button for Channel 1. Click the entry box and enter an identifier (See Figures D-2 and D-3). Then click Ok. Repeat for Channel 2 with a different identifier.
3. Select the **Start** button. If the Comm Port selection is correct there should be a display.
4. If no display is present (a center trace line should exist even if there is no wave form), click the **Stop** button twice to ensure that it is not in a hold position.
5. If there is still no display present, click **Stop**, then select Comm Port 1, then click **Start**. Repeat this for the other port numbers if necessary.
6. If there is still no display present, click **Stop**, then select a different Baud rate, then click **Start**. Repeat this for the other baud rates if necessary
7. If there is still no display present you may have a cabling problem. If you do now have a display, continue with File Management.

DMM Data Logger Management

1. Save a file to the default folder, or use the File Browser to select any folder, then enter the identifier in the entry box. You can also type the complete save sequence string directly into the save entry box if you know the path names
2. To restore a previously saved file into the display area you will need to use **Load**, however you will first have to **Stop** the current display.

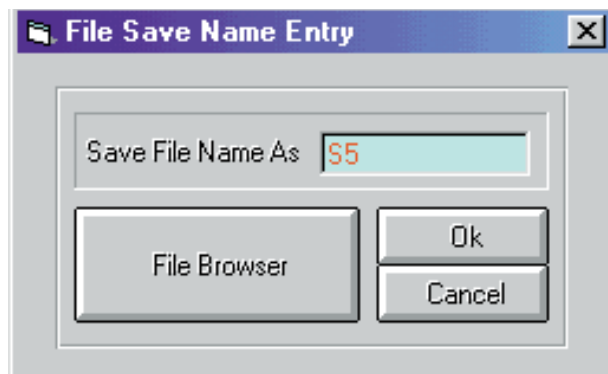
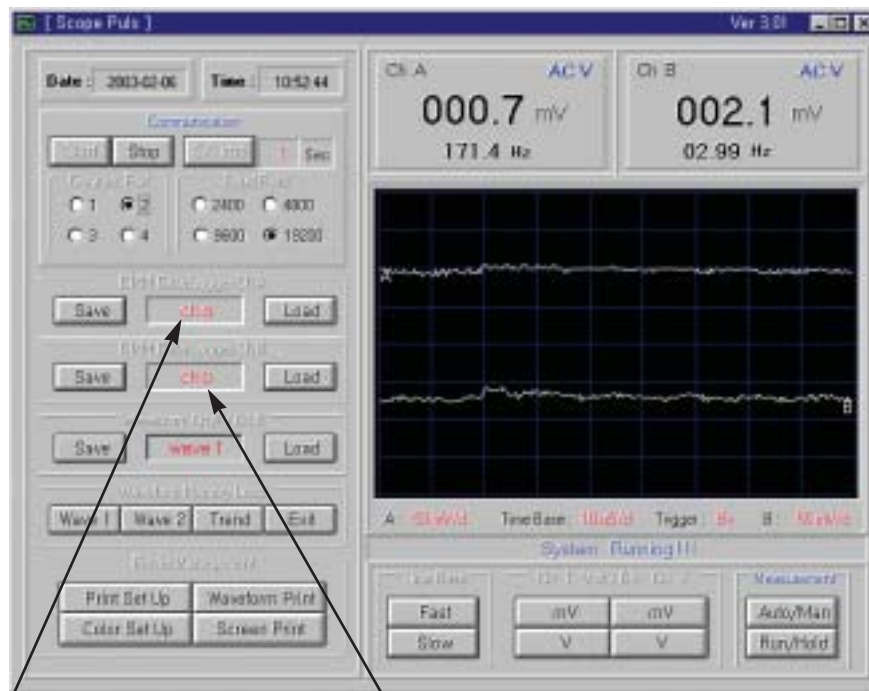

Figure D-2. Save Input Display



Channel 1 Identifier

Channel 2 Identifier

Figure D-3. Waveform Display with Identifiers

3. Press **Load** for Channel 1, and enter the load identifier into the entry box. Use the Browser utility if needed. Then click **Ok**. (See example in Fig. D-4). The result will be the waveform previously recorded.
4. Repeat for Channel B as required. Note that the **Print** option for the Data View dialog box is for the data entry only (not the waveform).

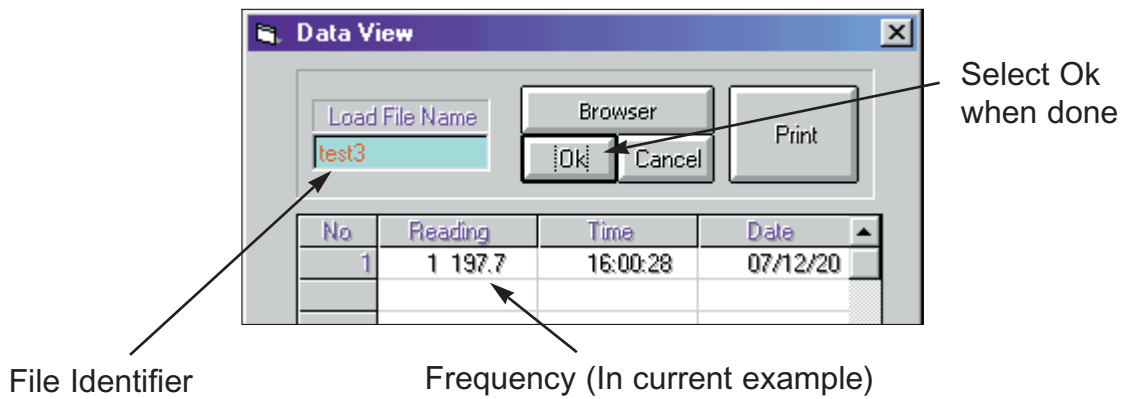

Figure D-4. DMM Data Load Example

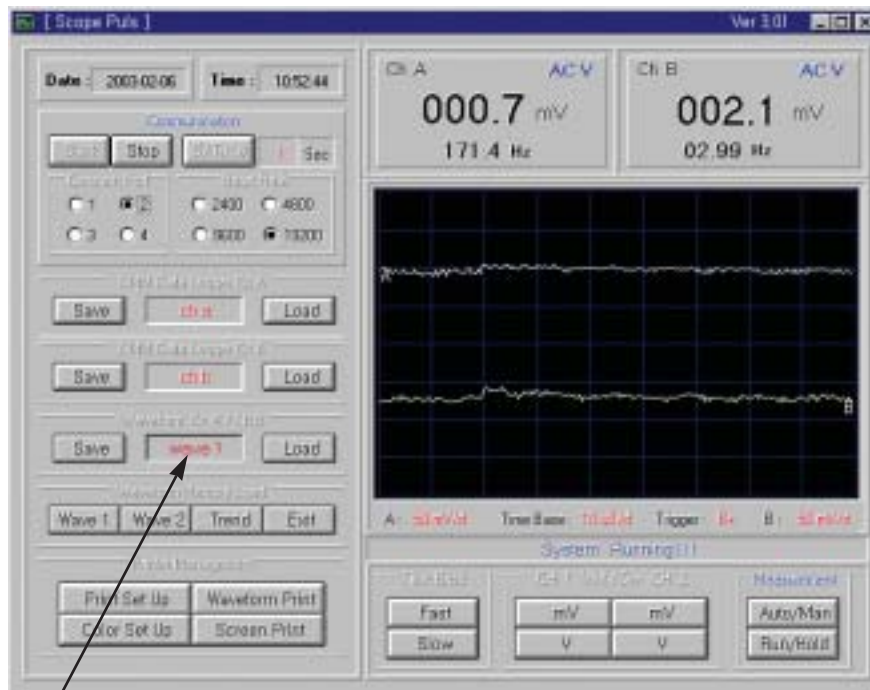

Figure D-5. Waveform 1 Recalled form scope

1. This is the function you can upload and store the waveform data(wave 1, 2, TREND) stored on the scope on the PC
2. Stop the communication and click the waveform you want to store. Then, the data will be uploaded on the PC and the above waveform will be displayed on the screen.
3. Enter the file name into the waveform file identifier entry box directly and press the save button. Then the waveform will be stored on the PC.
4. If you want to load the waveform data, use the file you entered on the step 3.

Print Management

The print management buttons are at the lower left part of the RS-232 display. See also Fig. D-6

Figure D-6. Print Management Options

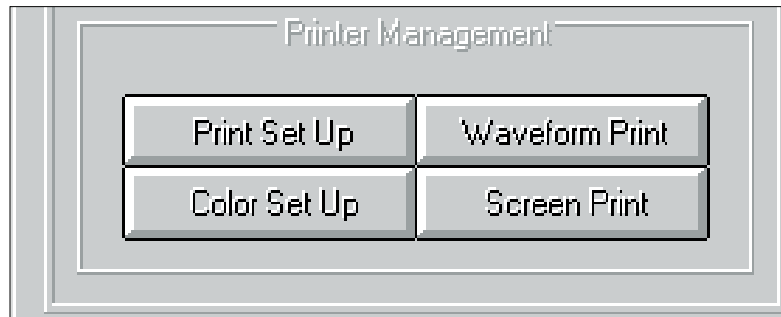

1. Use **Print Set Up** to set the line printer up in the same way you would for text. I.e: Location of printer and number of prints, etc. The only thing to remember here is that the dialog box will not display unless the RS-232 display has first been set to **Stop** (-That is the software has received instructions to temporarily cease communicating with the 460).
2. Use **Color Set Up** to specify the background, grid, and waveform colors as described in Set-Up on the first page of this appendix.
3. Use **Waveform Print** to print the actual waveforms displayed (See example in Fig. D-7). The included grid graduations will be to the same scale as used in the actual 460 display. The data and time recording at the top of the waveform display can be used to help sort a series of waveform captures.

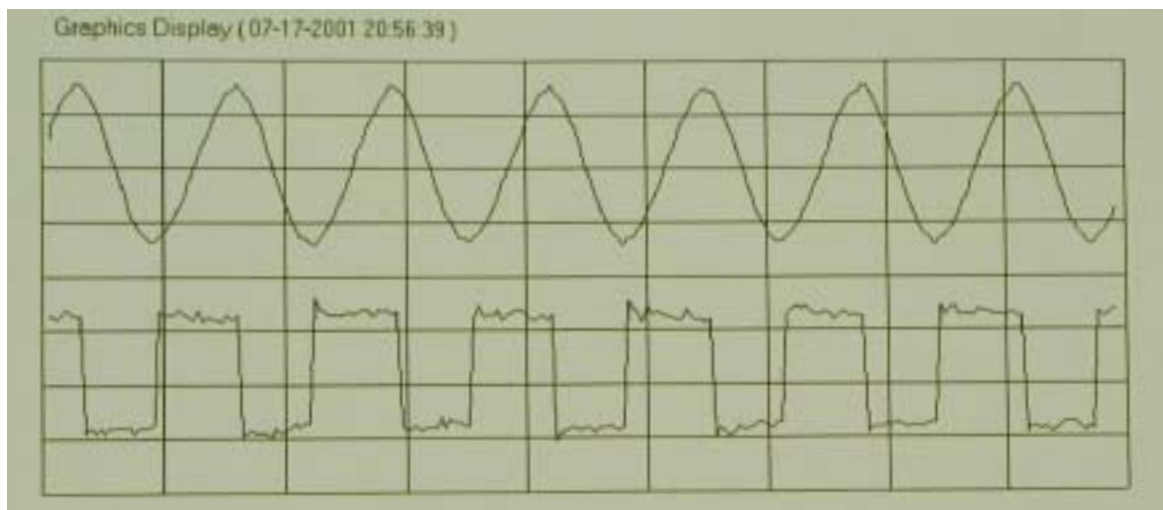

Figure D-7. Waveform Print Sample

4. Use **Screen Print** to print the whole display area including keys, waveform and identifiers. This print will preserve a copy of the information using the same color identification chosen for the screen display.

Controlling the A460 from the PC

There are four types of control available to control the 460 from the PC side. The following steps provide a walk-through. Refer to Fig D-8 for the control button identification.

Figure D-8. A460 Controls

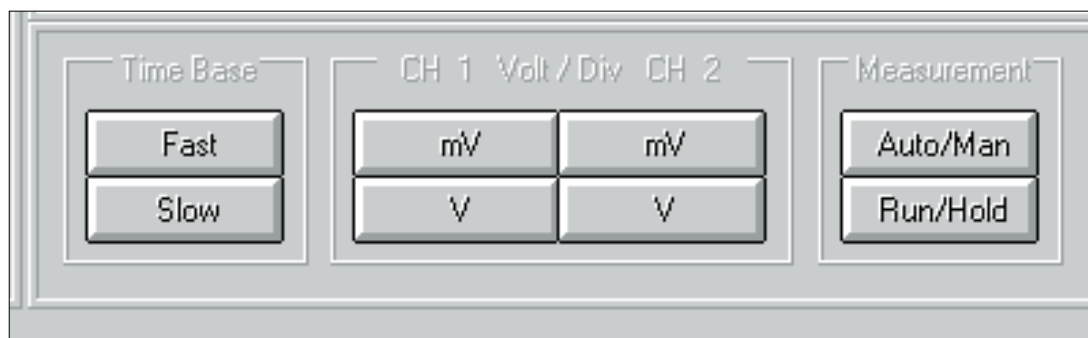

1. Use the **Time Base** controls labeled **Fast** and **Slow** to change the speed of the time base and hence the stretching or compression of the waveform as it appears on the screen (**Fast** will lengthen the pulse, while **Slow** will compress it). Note that each press of the keys will only advance or retard the time base by one step at a time.
2. Use the **mV/V** keys to size the waveform in terms of Volts per Division, which will effectively cause a change in the height of the displayed waveform (**mV** will effectively increase the height of the waveform, while **V** will decrease it). The same single press restrictions will apply as for the Time Base.
3. Use the **Auto/Man** key to set the 460 to either a manual setting or automatic. As with many of the RS-232 controls, there may be a short delay before the DMM accepts the command, so keep the mouse pointer on the button till this happens (Refer to Chapter 3 for Auto functions).
4. Use the **Run/Hold** key to accept the Sample Time Run updates or to place the 460 in a hold pattern. The latter choice is usually the best option when saving a waveform as otherwise you may catch the change after a new waveform update.

Archiving

This function in the 460 is normally carried out by using the **Save** display button. However, you may also choose to use a Screen Capture facility and open a separate file and folder to paste this into.

For remote archiving using the **Save** function, select the name you want the data saved under and then select the **File Browser** to choose the folder location. For a screen capture using Windows, press **Ctrl**, hold the button down and then press **PrtSc** (Print Screen). You can then retrieve the paste after you have opened the destination folder or other receiving facility such as Microsoft PowerPoint.

Special Applications

The A460 with the RS-232C facility offers a powerful tool in waveform evaluation and testing management. The following suggestions of usage are just a few of many the many choices you can pursue to increase your TPI Scope Plus 460 investment opportunities.

- Catalog near-perfect waveforms and then use parameters based on these as Pass/Fail limits on new incoming waveforms from the same source.
- Use a graphics program to enlarge the scale of the waveforms in order to examine small perturbations on these, or to match and sort differences with previously captured waveforms.
- Create a split-screen presentation between archived displays and the current RS-232C display.
- Use the captured 460 text data to log performance of a DUT (Device Under Test) over long periods of time.

Appendix E

Troubleshooting

This chapter provides a resource for troubleshooting the hand-held TPI Scope Plus 460. Common problems are addressed from the point of view of the new user, and responded to with methods that correct the problem in a majority of cases. Try these solutions before calling the TPI service department for assistance.

Coverage

The following troubleshooting problems have been identified. If you find a problem and an answer which is not in this list, please send it to us for inclusion in the next update of this appendix. If you do not find a question or answer to your current problem, please call a service representative from your local dealership, or by calling the number shown on the inside cover sheet of this manual.

- Cannot read screen characters or oscilloscope trace
- Some front panel buttons do not give the same results when pressed.
- The A460 switches off by itself.
- Waveform shapes appear to be effected when using the 10:1 probe.
- RS-232 link will not capture waveforms.
- RS-232 Waveform updates very slowly
- Trouble effectively archiving RS-232 waveforms

Cannot read Screen Characters

The most likely problem is that the contrast adjustment is set incorrectly, or that the memory did not maintain storage of the settings the last time it was adjusted due to battery disconnection.

Use the procedure provided in Chapter 2 (“Getting Started”) to correct the basic contrast adjustment. Note that the brightness adjustment will also effect readability and may need to be cycled through its ten steps to ensure the correct level.

Check for cover film. When the 460 is shipped, the screen is covered with a thin mylar film that is removable but hard to see. Check the edges of the display screen. If you see a raised edge, use tweezers or your nail to peel the sheet back. You should have a more visible screen as a result.

If none of the above methods work in your case, the battery is suspect. Refer to Appendix B to check and/or replace your battery.

If the battery is replaced, you will need to re-perform the contrast setting described in Chapter 2.

Front Panel Buttons do not give consistent results

Many of the front panel buttons are dual purpose. The second time they are pressed will produce the alternative menu. These buttons include:

	Button	First Option	Second Option
o	USER:	EXIT, CONTRAST, RS-232C, POWER DOWN	A-MOVE, TRIGGER, TREND, B-MOVE
o	SCOPE:	PROBES SELECT, PROBES ADJUST, ENTER	A-MOVE, TRIGGER TREND, B-MOVE
	SAVE	SCREEN SAVE	A-MOVE, TRIGGER TREND, B-MOVE

Note that the second option is always the one beginning with the A-MOVE. This is true regardless of the last setting of the USER key. E.g. If the USER key has the EXIT menu chosen, then the SCOPE key is pressed (resulting in PROBES SELECT), the next time SCOPE is pressed, the screen will revert to the A-MOVE menu.

Refer to Chapter 3 for a full list of key/menu interactions.

The A460 Switches OFF by itself

The 460 has an on-screen menu option to time itself off. This menu is found by pressing the USER button, then F4, then ENTER. Notice that the menu gives the user a total of four options. If an option other than DISABLE has been previously selected, it will remain the selection unless changed.

To disable the Power Down function, chose DISABLE and then press F4 to record the selection.

Waveform Shapes effected by the 10:1 Probe

The 10:1 probe includes an adjustment which can effect the shape of the waveform you are measuring. The adjustment is intended to compensate for different levels of input capacitance (commonly encountered at the interface connection points of instruments). In this subsection we will look at the effect of this adjustment for different kinds of waveforms.

Figures E-1 through E-3 show three different kinds of waveform: Sine, square, and sawtooth. The (a) versions of each waveform are those showing the maximum effects of incorrect compensa-

tion. The (b) versions show correct compensation.

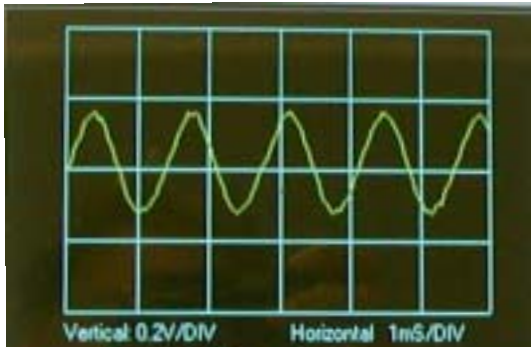

Fig. E-1(a) Uncompensated Sinewave



Fig. E-1(b) Compensated Sinewave

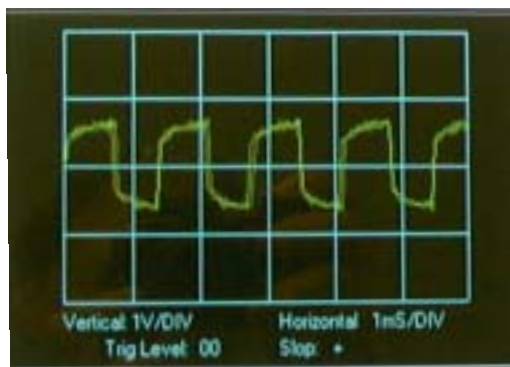

Fig. E-2(a) Uncompensated Squarewave

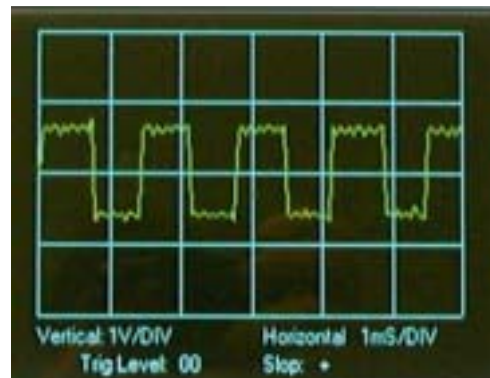

Fig. E-2(b) Compensated Squarewave

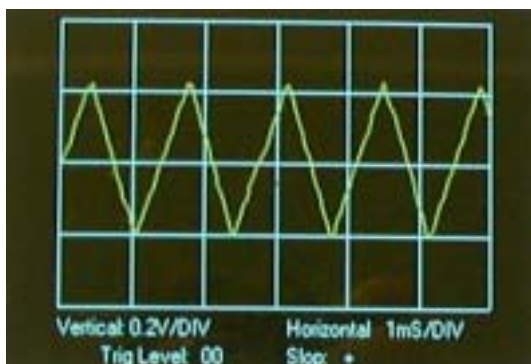

Fig. E-3(a) Uncompensated Sawtooth

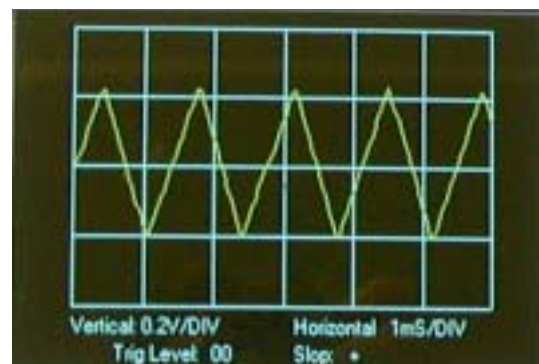

Fig. E-3(b) Compensated Sawtooth

Note that in terms of shape, the sine and sawtooth waveforms are hardly effected. Only the squaretooth waveform shows excessive shape change effect and, for this type of attenuation, mostly effecting the leading edge.

Refer to the procedure outlined in chapter 4 which uses a square wave to adjust the 10:1 probe for proper compensation

RS-232 link will not capture waveforms.

This problem is usually associated with the computer not looking at the right port. The display software is local to the PC, but the data is coming across the 440 computer interconnect. Also, the software driver will not allow a new port to be addressed without the connection being effectively shut down.

On the RS-232 display, note the Comm Port and Baud Rates being addressed. Defaults are usually 9600 Baud and Comm Port 2. Click the Stop button. Click Comm Port 1, then click Start. This usually will fix the problem. If not, go through all the Comm Port options, being sure to cycle the Stop/Start buttons between each choice. If you still do not see the trace displayed, repeat the same process with a different Baud Rate.

A less common problem, but one you should check, is that the chosen trace/graph color is different from the background color. Select Color Set Up, and check or change the three color option boxes. Once you click a color box you will be presented with a full color palette to chose from.

Once you have selected choices from the above options, the settings will remain until they are re-selected and changed.

RS-232 Waveform updates too slowly

This problem could be Baud Rate or sample time. If the displayed Baud Rate is slower than 9600, try the faster rate. Select Stop, then 9600, then Start.

The Sample Rate (S/Rate), is selectable from 1 to 9999 seconds. Click the S/Rate box, then enter the required sample rate. The fastest available sample rate is 1 Sec.

Trouble effectively archiving RS-232 waveforms

The following problems could arise when attempting to archive waveforms captured using the RS-232C / PC interface

- The RS 232 screen was not issued a file name / identifier to store the waveform under. Use the mouse to click on the save button and enter an identifier label in the **Save File Name As** dialog box. Then click Ok.

- You may have attempted to bring in the waveform without first assigning a file identifier. Switch the display off using the screen **Stop** button, assign an identifier or file string and location name, then select **Start**.
- You chose a file string or extension that was not compatible with the type needed for storage of waveforms. Try entering a simple file name such as WV20 in the default (Local) folder, then clicking **Ok**. You can verify this save by clicking the **File Browser** to see if the new file name is there.