

CoolMOS™ 1) Power MOSFET

N-Channel Enhancement Mode
 Low $R_{DS(on)}$, High V_{DSS} MOSFET
 Ultra low gate charge

I_{D25} = 70 A
 V_{DSS} = 600 V
 $R_{DS(on) \text{ max}}$ = 0.045 Ω



TO-247 AD (IXKH)

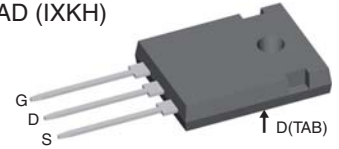

MOSFET			
Symbol	Conditions	Maximum Ratings	
V_{DSS}	$T_{VJ} = 25^{\circ}\text{C}$	600	V
V_{GS}		± 20	V
I_{D25}	$T_C = 25^{\circ}\text{C}$	70	A
I_{D90}	$T_C = 90^{\circ}\text{C}$	48	A
E_{AS} E_{AR}	single pulse repetitive } $I_D = 11 \text{ A}; T_C = 25^{\circ}\text{C}$	1950 3	mJ mJ
dV/dt	MOSFET dV/dt ruggedness $V_{DS} = 0 \dots 480 \text{ V}$	50	V/ns

Features

- fast CoolMOS™ 1) power MOSFET 4th generation
- High blocking capability
- Lowest resistance
- Avalanche rated for unclamped inductive switching (UIS)
- Low thermal resistance due to reduced chip thickness
- Enhanced total power density

Applications

- Switched mode power supplies (SMPS)
- Uninterruptible power supplies (UPS)
- Power factor correction (PFC)
- Welding
- Inductive heating
- PDP and LCD adapter

Symbol	Conditions	Characteristic Values			
		$(T_{VJ} = 25^{\circ}\text{C}, \text{ unless otherwise specified})$			
		min.	typ.	max.	
$R_{DS(on)}$	$V_{GS} = 10 \text{ V}; I_D = 44 \text{ A}$		40	45	m Ω
$V_{GS(th)}$	$V_{DS} = V_{GS}; I_D = 3 \text{ mA}$	2.5	3	3.5	V
I_{DSS}	$V_{DS} = 600 \text{ V}; V_{GS} = 0 \text{ V}$			10	μA
			50		μA
I_{GSS}	$V_{GS} = \pm 20 \text{ V}; V_{DS} = 0 \text{ V}$			100	nA
C_{iss}	} $V_{GS} = 0 \text{ V}; V_{DS} = 100 \text{ V}$ $f = 1 \text{ MHz}$		6800		pF
C_{oss}				320	
Q_g	} $V_{GS} = 0 \text{ to } 10 \text{ V}; V_{DS} = 400 \text{ V}; I_D = 44 \text{ A}$		150	190	nC
Q_{gs}			35		nC
Q_{gd}			50		nC
$t_{d(on)}$	} $V_{GS} = 10 \text{ V}; V_{DS} = 400 \text{ V}$ $I_D = 44 \text{ A}; R_G = 3.3 \Omega$		30		ns
t_r			20		ns
$t_{d(off)}$			100		ns
t_f			10		ns
R_{thJC}				0.2	K/W

¹⁾ CoolMOS™ is a trademark of Infineon Technologies AG.

Source-Drain Diode

Symbol	Conditions	Characteristic Values		
		min.	typ.	max.
($T_{VJ} = 25^{\circ}\text{C}$, unless otherwise specified)				
I_S	$V_{GS} = 0\text{ V}$		44	A
V_{SD}	$I_F = 44\text{ A}; V_{GS} = 0\text{ V}$	0.9	1.2	V
t_{rr}	} $I_F = 44\text{ A}; -di_F/dt = 100\text{ A}/\mu\text{s}; V_R = 400\text{ V}$	600		ns
Q_{RM}		17		μC
I_{RM}		60		A

Component

Symbol	Conditions	Maximum Ratings	
T_{VJ}	operating	-55...+150	$^{\circ}\text{C}$
T_{stg}		-55...+150	$^{\circ}\text{C}$
M_d	mounting torque	0.8 ... 1.2	Nm

Symbol	Conditions	Characteristic Values		
		min.	typ.	max.
R_{thCH}	with heatsink compound	0.25		K/W
Weight		6		g

TO-247 AD Outline

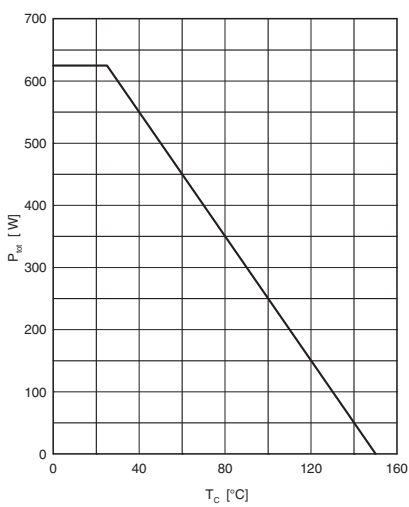
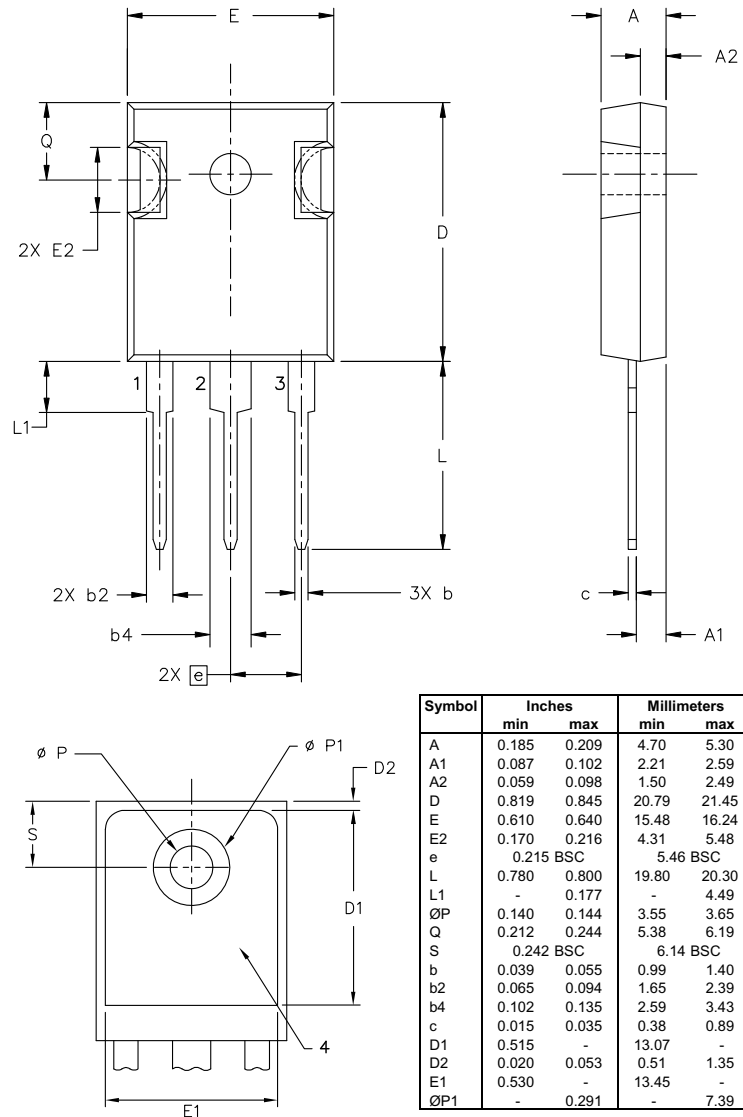

Fig. 1 Power dissipation

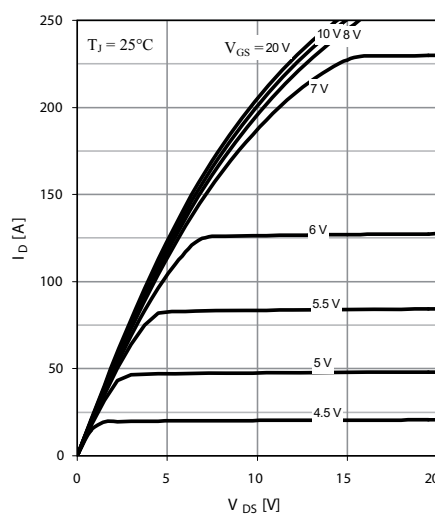

Fig. 2 Typ. output characteristics

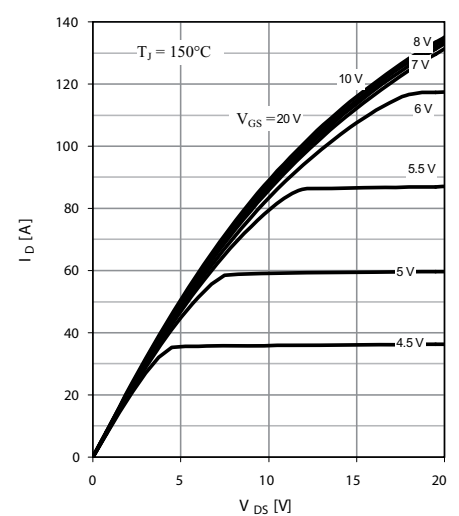

Fig. 3 Typ. output characteristics

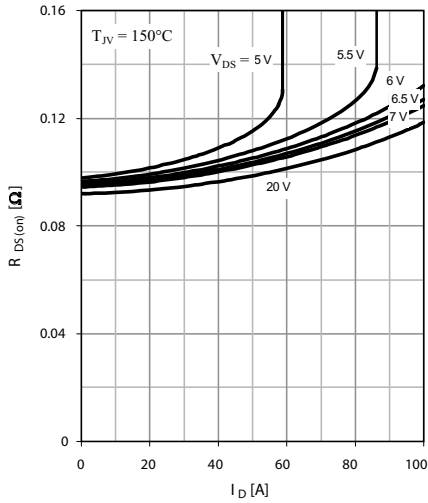

Fig. 4 Typ. drain-source on-state resistance characteristics of IGBT

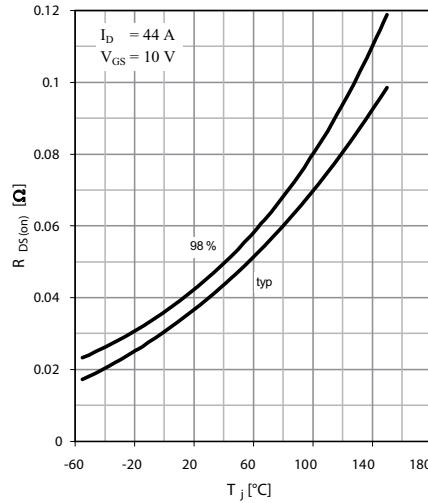

Fig. 5 Drain-source on-state resistance

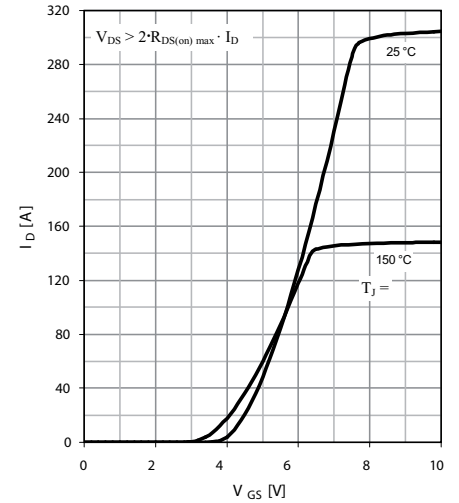

Fig. 6 Typ. transfer characteristics

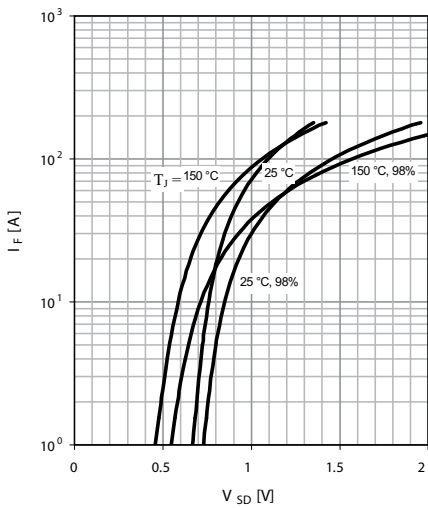

Fig. 7 Forward characteristic of reverse diode

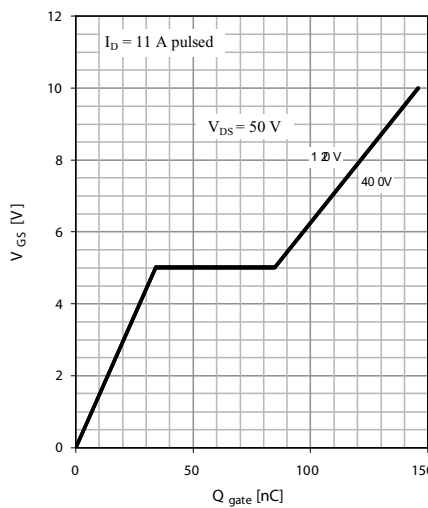

Fig. 8 Typ. gate charge

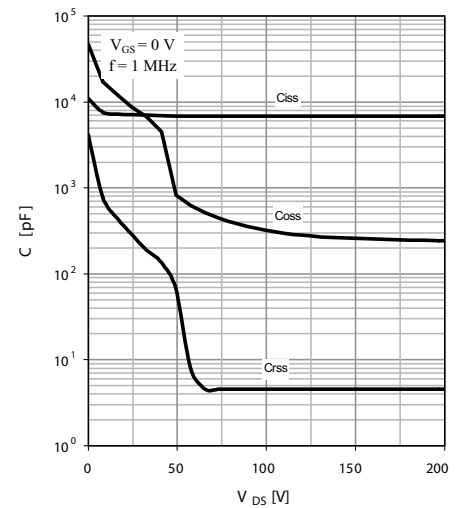

Fig. 9 Typ. capacitances

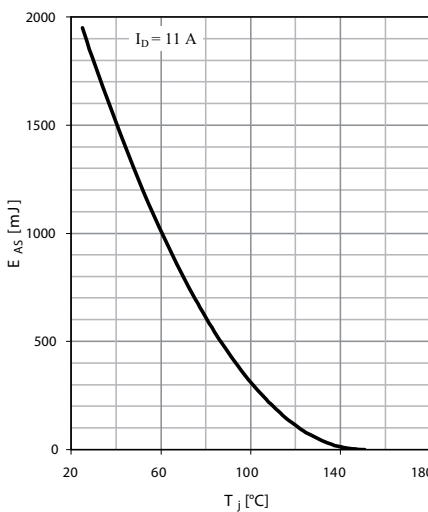

Fig. 10 Avalanche energy

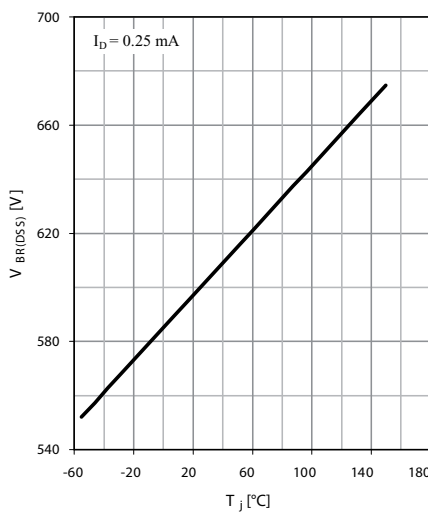

Fig. 11 Drain-source breakdown voltage

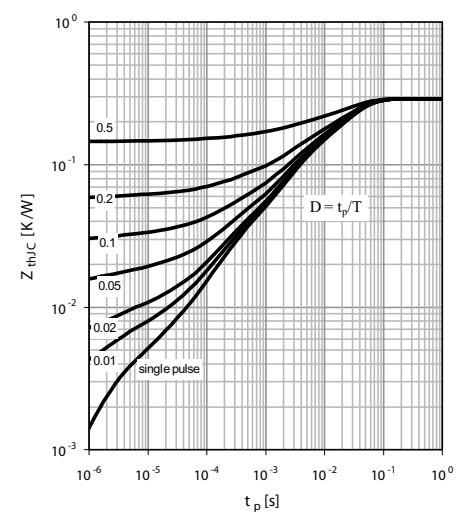

Fig. 12 Max. transient thermal impedance

IXYS reserves the right to change limits, test conditions and dimensions.

20090209d