

C1608C0G2A822J080AE

TDK Item Description : C1608C0G2A822JT***S



Application & Main Feature

Commercial Grade (Soft Termination)

Series

C1608 [EIA CC0603]

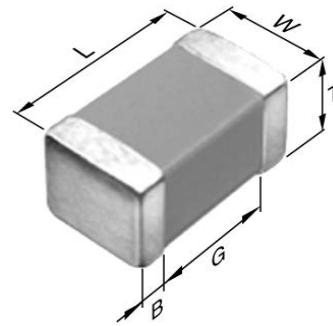

Dimensions

L	1.60mm +0.2,-0.1mm
W	0.80mm +0.15,-0.1mm
T	0.80mm +0.15,-0.1mm
B	0.20mm Min.
G	0.30mm Min.

Temperature Characteristic

C0G (-55 to 125 degC 0+/-30ppm/degC)

Rated Voltage

2A (100Vdc)

Capacitance

8.2nF

Capacitance Tolerance

J (+/-5%)

Q Factor

1000 Min.

Insulation Resistance

10Gohm Min

AEC-Q200

Not Applicable

**|Z|, ESR vs. Freq. Characteristics
(Simulation Data)**

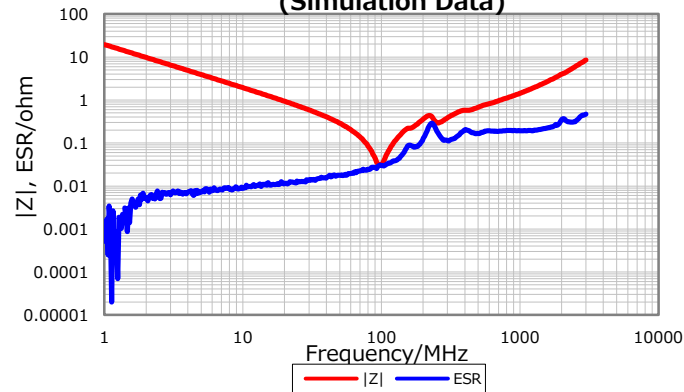

DC Bias Characteristic

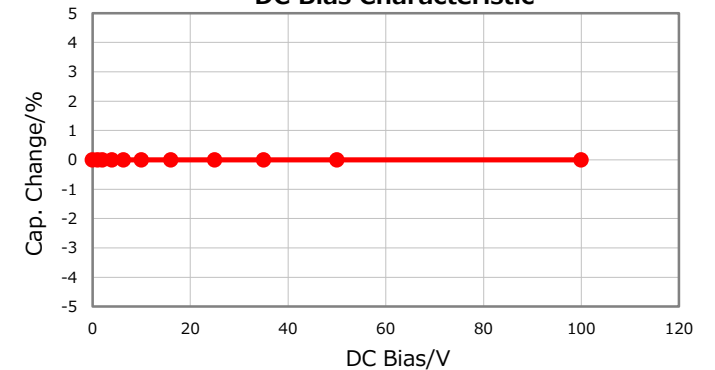

Cap. vs. Freq. Characteristic

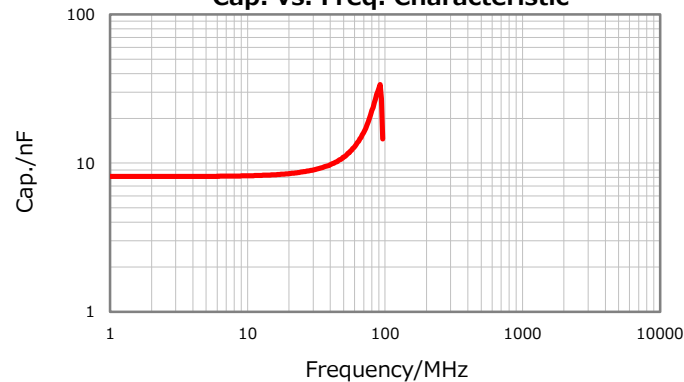

Temperature Characteristics

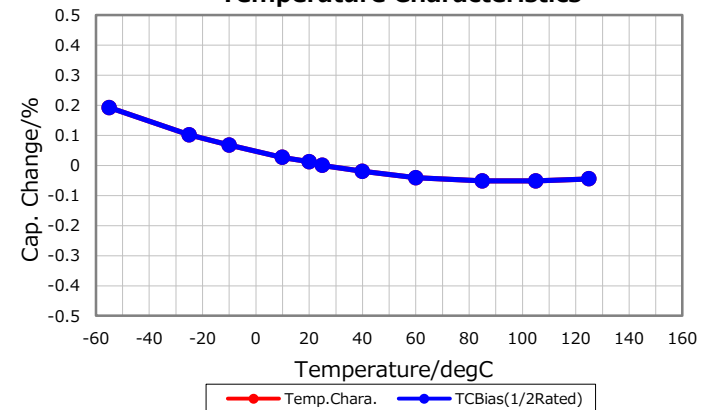

Characterization Sheet (Multilayer Ceramic Chip Capacitors)



All specifications are subject to change without notice.

May 12, 2017