



**ATTENTION**  
OBSERVE PRECAUTIONS  
FOR HANDLING  
ELECTROSTATIC  
DISCHARGE  
SENSITIVE  
DEVICES

Part Number: APBD3224LSURKQBDC

Hyper Red  
Blue

### Features

- 3.2x2.4mm SMD LED, 2.4mm thickness.
- Low power consumption.
- Ideal for backlight and indicator.
- Package : 1500pcs / reel.
- Moisture sensitivity level : level 3.
- Low current IF=2mA operating.
- RoHS compliant.

### Descriptions

- The Hyper Red source color devices are made with Al GaInP on GaAs substrate Light Emitting Diode.
- The Blue source color devices are made with InGaN Light Emitting Diode.
- Electrostatic discharge and power surge could damage the LEDs.
- It is recommended to use a wrist band or anti-electrostatic glove when handling the LEDs.
- All devices, equipments and machineries must be electrically grounded.

### Package Dimensions

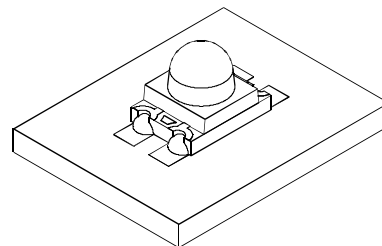
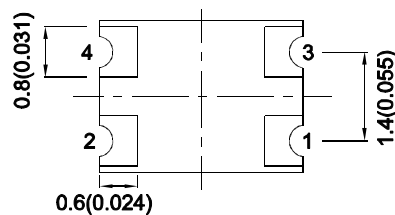
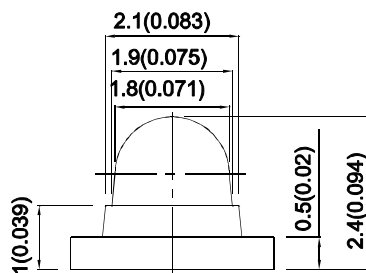
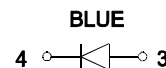
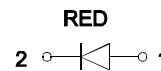
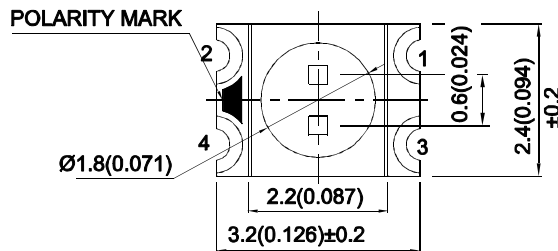

#### Notes:

1. All dimensions are in millimeters (inches).
2. Tolerance is  $\pm 0.1(0.004)$  unless otherwise noted.
3. The specifications, characteristics and technical data described in the datasheet are subject to change without prior notice.
4. The device has a single mounting surface. The device must be mounted according to the specifications.



## Selection Guide

Part No.	Emitting Color (Material)	Lens Type	Iv (mcd) [2] @ 2mA		Viewing Angle [1]
			Min.	Typ.	2θ1/2
APBD3224LSURKQBDC	Hyper Red (AlGaInP)	Water Clear	20	50	20°
			10*	30*	
	Blue (InGaN)		20	40	
			20*	40*	

**Notes:**

1. θ1/2 is the angle from optical centerline where the luminous intensity is 1/2 of the optical peak value.

2. Luminous intensity/ Luminous Flux: +/-15%.

\* Luminous intensity value is traceable to the CIE127-2007 compliant national standards.

## Electrical / Optical Characteristics at TA=25°C

Symbol	Parameter	Emitting Color	Min.	Typ.	Max.	Units	Test Conditions
λpeak	Peak Wavelength	Hyper Red Blue		645 460		nm	IF=2mA
λD [1]	Dominant Wavelength	Hyper Red Blue		630 465		nm	IF=2mA
Δλ1/2	Spectral Line Half-width	Hyper Red Blue		28 25		nm	IF=2mA
C	Capacitance	Hyper Red Blue		35 100		pF	VF=0V;f=1MHz
VF [2]	Forward Voltage	Hyper Red Blue	1.5 2.2	1.75 2.65	2.1 3	V	IF=2mA
IR	Reverse Current	Hyper Red Blue			10 50	uA	VR = 5V

**Notes:**

1. Wavelength: +/-1nm.

2. Forward Voltage: +/-0.1V.

3. Wavelength value is traceable to the CIE127-2007 compliant national standards.

4. Excess driving current and/or operating temperature higher than recommended conditions may result in severe light degradation or premature failure.

## Absolute Maximum Ratings at TA=25°C

Parameter	Hyper Red	Blue	Units
Power dissipation	63	90	mW
DC Forward Current	30	30	mA
Peak Forward Current [1]	185	150	mA
Electrostatic Discharge Threshold (HBM)	-	250	V
Reverse Voltage	5		V
Operating Temperature	-40°C To +85°C		
Storage Temperature	-40°C To +85°C		

**Note:**

1. 1/10 Duty Cycle, 0.1ms Pulse Width.

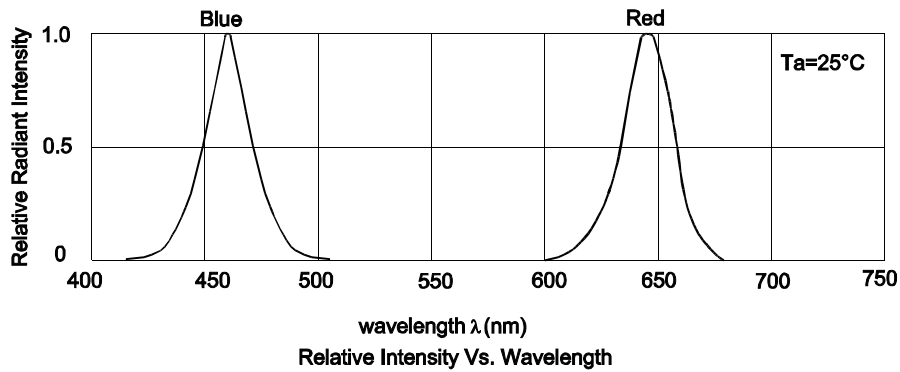

## APBD3224LSURQBDC Hyper Red

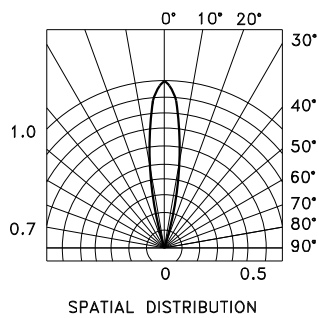
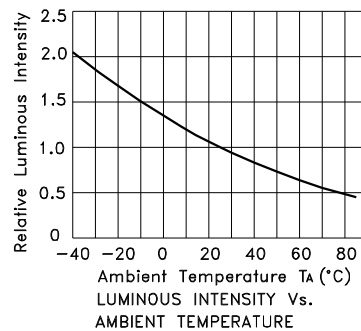
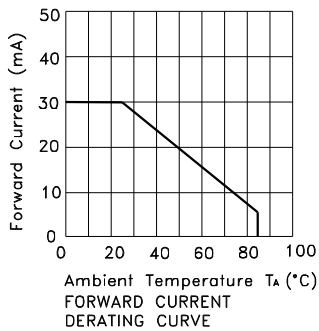
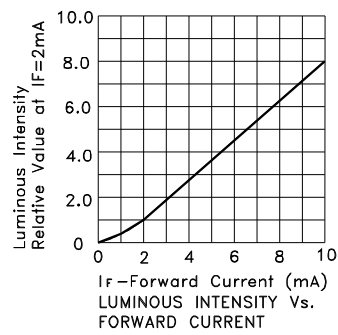
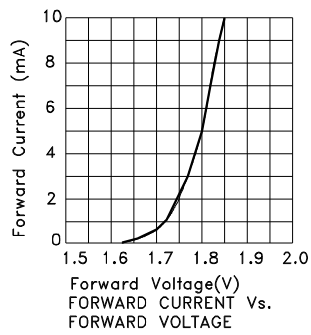

# Kingbright

## Blue

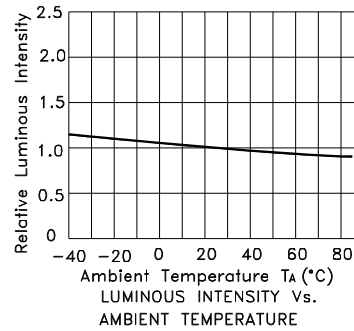
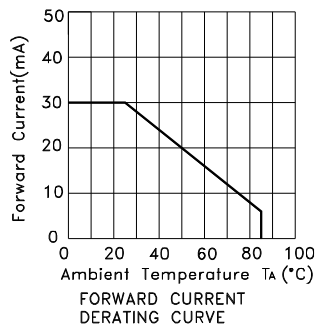
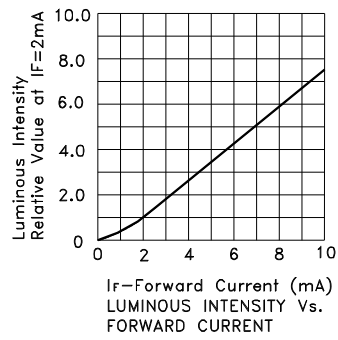
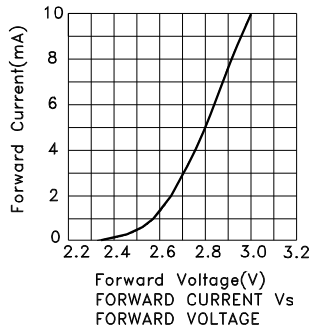

## APBD3224LSURKQBDC

Reflow soldering is recommended and the soldering profile is shown below.  
Other soldering methods are not recommended as they might cause damage to the product.

Reflow Soldering Profile For Lead-free SMT Process.



NOTES:

1. We recommend the reflow temperature 245°C (+/-5°C). The maximum soldering temperature should be limited to 260°C.
2. Don't cause stress to the epoxy resin while it is exposed to high temperature.
3. Number of reflow process shall be 2 times or less.

### Recommended Soldering Pattern (Units : mm; Tolerance: ± 0.1)



### Reel Dimension



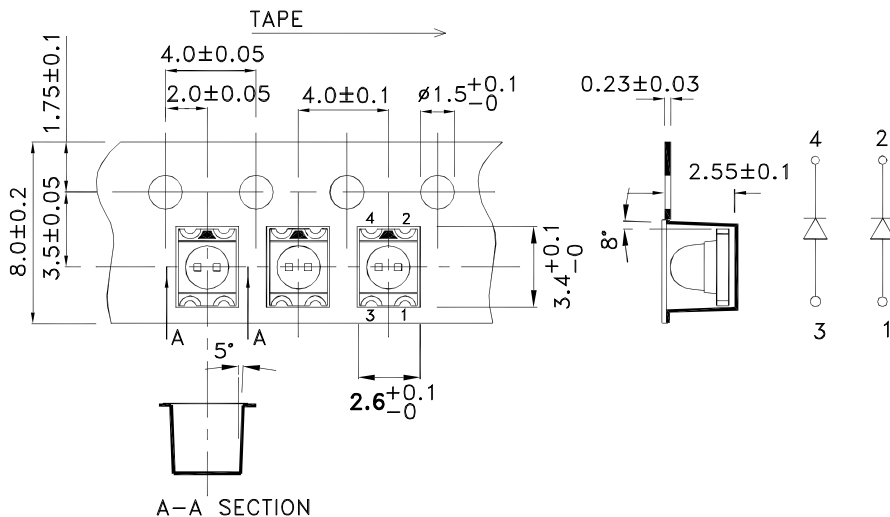

### Tape Dimensions (Units : mm)

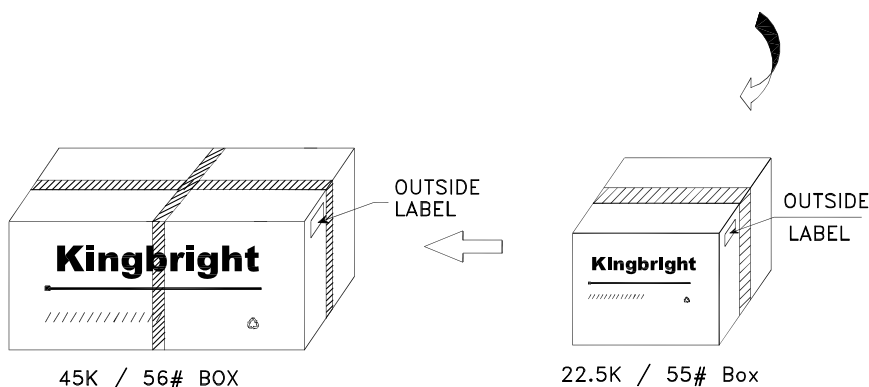
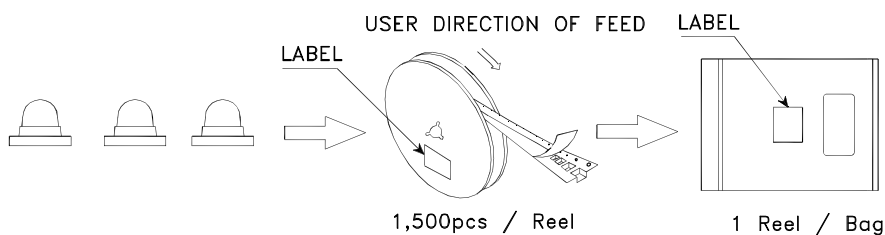

## PACKING & LABEL SPECIFICATIONS

APBD3224LSURKQBDC



<h1>Kingbright</h1>	
P/NO: APBD3224xxx	
QTY: 1,500 pcs	Q.C. <span style="border: 1px solid black; border-radius: 50%; padding: 2px;">Q C xx xx xxxx PASSED</span>
S/N: XXXX	
CODE: XXX	
LOT NO:	
	
RoHS Compliant	

### Terms and conditions for the usage of this document

1. The information included in this document reflects representative usage scenarios and is intended for technical reference only.
2. The part number, type, and specifications mentioned in this document are subject to future change and improvement without notice. Before production usage customer should refer to the latest datasheet for the updated specifications.
3. When using the products referenced in this document, please make sure the product is being operated within the environmental and electrical limits specified in the datasheet. If customer usage exceeds the specified limits, Kingbright will not be responsible for any subsequent issues.
4. The information in this document applies to typical usage in consumer electronics applications. If customer's application has special reliability requirements or have life-threatening liabilities, such as automotive or medical usage, please consult with Kingbright representative for further assistance.
5. The contents and information of this document may not be reproduced or re-transmitted without permission by Kingbright.
6. All design applications should refer to Kingbright application notes available at <http://www.KingbrightUSA.com/ApplicationNotes>