



GaAs MMIC NON-REFLECTIVE DIFFERENTIAL SPDT SWITCH, DC - 4 GHz

Typical Applications

The HMC922LP4E is ideal for:

- Test & Measurement Equipment
- Antenna Diversity & Selector Selection
- Broadband Switch Matrices
- Military, EW & ECM
- SATCOM & Space

Features

- Differential SPDT Functionality
- Low Insertion Loss: 0.8 dB
- High IP3: +50 dBm
- High Input P1dB: +35 dBm
- Positive Control: 0/+3V to 0/+5V
- 24 Lead 4x4 mm QFN Package: 16 mm²

Functional Diagram

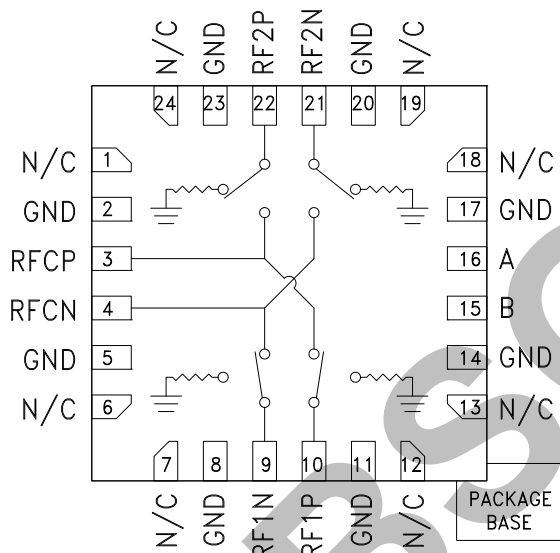

General Description

The HMC922LP4E is a DC to 4 GHz high isolation GaAs MMIC non-reflective Differential SPDT switch in a low cost leadless surface mount package. The switch is ideal for antenna diversity & selector selection, broadband switch matrices, test & measurement equipment, military and space applications yielding up to 60 dB isolation, low 0.8 dB insertion loss and +50 dBm input IP3. Power handling is excellent with the switch offering a P1dB compression point of +35 dBm. On-chip circuitry allows two positive voltage controls of 0/+3V to 0/+5V at very low DC currents.

Electrical Specifications,

$T_A = +25^\circ\text{C}$, $V_{ctl} = 0/+3\text{Vdc}$ (Unless Otherwise Stated), 50 Ohm System

Parameter	Frequency	Min.	Typ.	Max.	Units
Insertion Loss	DC - 2.0 GHz		0.8	1.2	dB
	2.0 - 4.0 GHz		1.2	1.5	dB
Isolation:	State 1: RFCN-RF2P, RFCN-RF2N, RFCP-RF2N, RFCP-RF2P	DC - 2.0 GHz	45	60	dB
	State 2: RFCN-RF1P, RFCN-RF1N, RFCP-RF1N, RFCP-RF1P	2.0 - 4.0 GHz	40	45	dB
Isolation	State 1: RFCN-RF1P, RFCP-RF1N	DC - 2.0 GHz	30	40	dB
	State 2: RFCN-RF2P, RFCP-RF2N	2.0 - 4.0 GHz	20	30	dB
Return Loss (On State, Any Port)	DC - 2.0 GHz		20		dB
	2.0 - 4.0 GHz		15		dB
Input Power for 1 dB Compression	0.5 - 4.0 GHz	$V_{ctl} = 0/+3V$	30		dBm
		$V_{ctl} = 0/+5V$	35		dBm
Input Power for 0.1 dB Compression	0.5 - 4.0 GHz	$V_{ctl} = 0/+3V$	27		dBm
		$V_{ctl} = 0/+5V$	32		dBm
Input Third Order Intercept (Two-Tone Input Power= +7 dBm Each Tone)	0.5 - 4.0 GHz	$V_{ctl} = 0/+3V$	50		dBm
		$V_{ctl} = 0/+5V$	50		dBm
Switching Characteristics	DC - 4.0 GHz	tRISE / tFALL (10/90% RF)	15		ns
		tON / tOFF (50% CTL to 10/90% RF)	40		ns

Information furnished by Analog Devices is believed to be accurate and reliable. However, no responsibility is assumed by Analog Devices for its use, nor for any infringements of patents or other rights of third parties that may result from its use. Specifications subject to change without notice. No license is granted by implication or otherwise under any patent or patent rights of Analog Devices. Trademarks and registered trademarks are the property of their respective owners.

For price, delivery, and to place orders: Analog Devices, Inc., One Technology Way, P.O. Box 9106, Norwood, MA 02062-9106 Phone: 781-329-4700 • Order online at www.analog.com Application Support: Phone: 1-800-ANALOG-D



GaAs MMIC NON-REFLECTIVE DIFFERENTIAL SPDT SWITCH, DC - 4 GHz

Insertion Loss

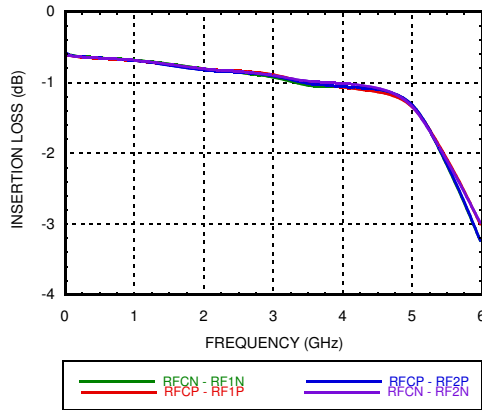

Insertion Loss vs. Temperature

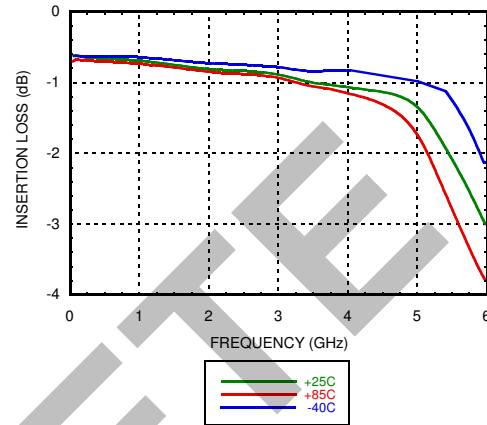

Isolation State 1

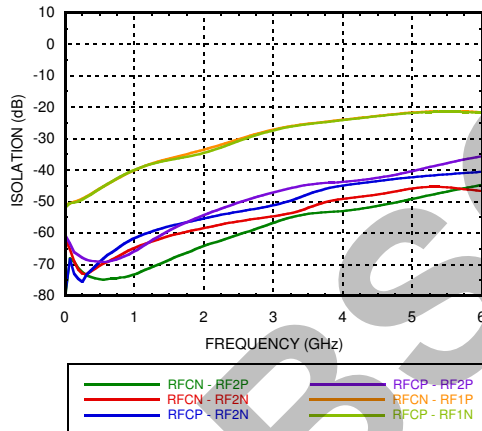

Isolation State 2

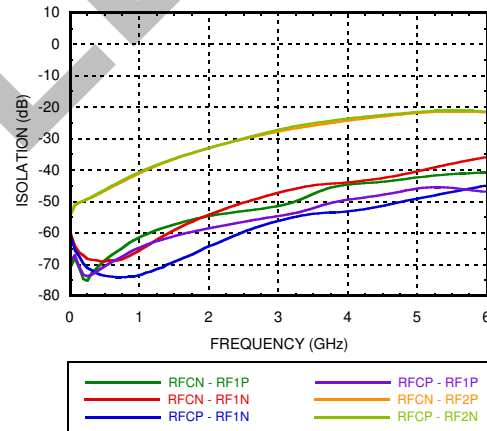

Return Loss RFC

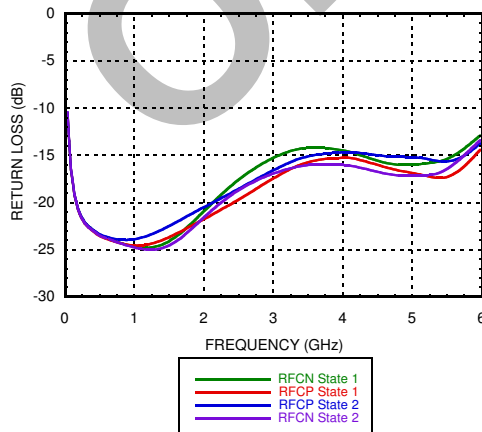

Return Loss RF1, 2

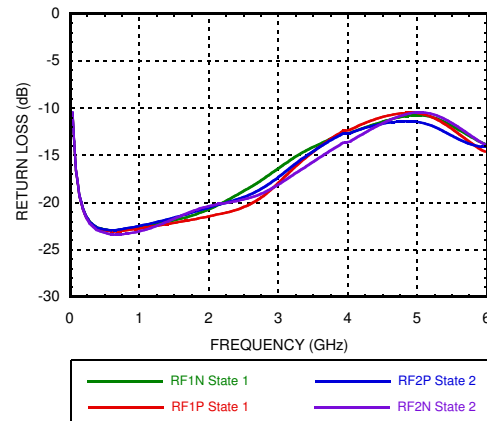



GaAs MMIC NON-REFLECTIVE DIFFERENTIAL SPDT SWITCH, DC - 4 GHz

SWITCHES - SMT

Off State Return Loss

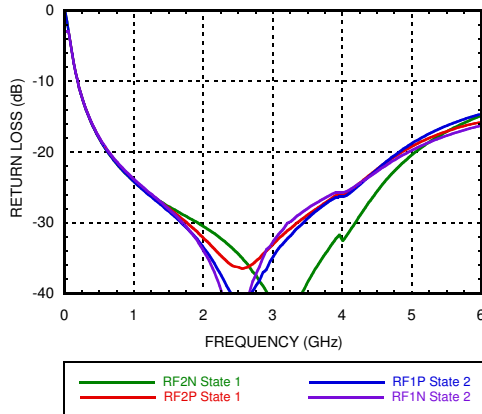

Input IP3* @ 3V

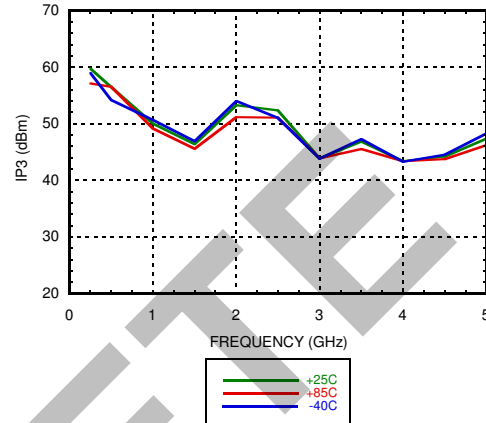

Input 0.1dB & 1 dB Compression Point @ 3V

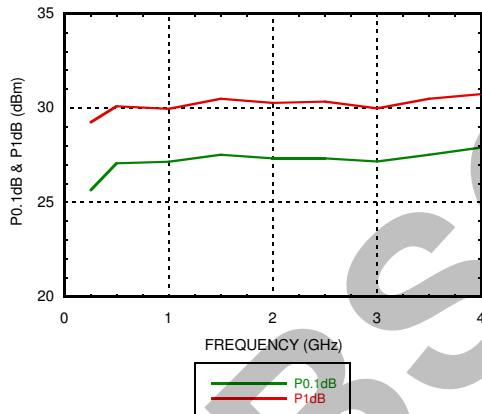

Input 0.1dB Compression Point vs. Temperature @ 3V

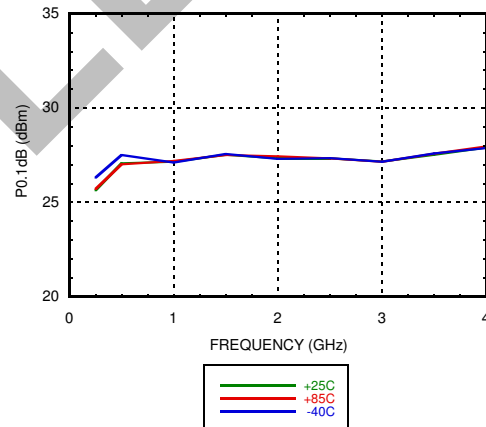

Input IP3 * @ 5V

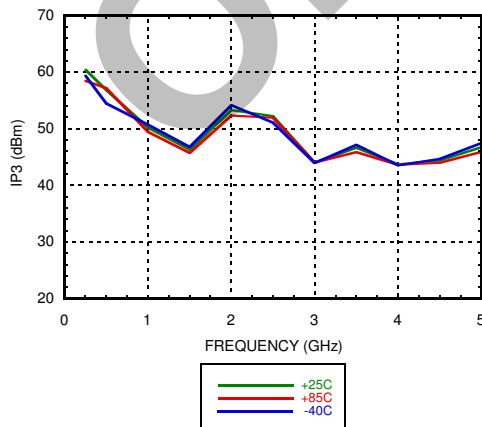

Input 0.1 dB & 1 dB Compression Point @ 5V

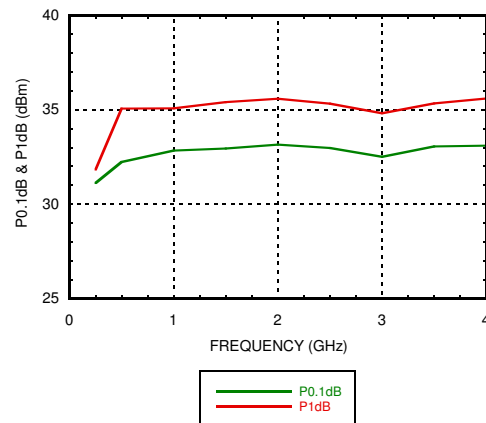

* Two-tone input power = +7 dBm each tone, 1 MHz spacing.

Information furnished by Analog Devices is believed to be accurate and reliable. However, no responsibility is assumed by Analog Devices for its use, nor for any infringements of patents or other rights of third parties that may result from its use. Specifications subject to change without notice. No license is granted by implication or otherwise under any patent or patent rights of Analog Devices. Trademarks and registered trademarks are the property of their respective owners.

For price, delivery, and to place orders: Analog Devices, Inc., One Technology Way, P.O. Box 9106, Norwood, MA 02062-9106 Phone: 781-329-4700 • Order online at www.analog.com Application Support: Phone: 1-800-ANALOG-D



GaAs MMIC NON-REFLECTIVE DIFFERENTIAL SPDT SWITCH, DC - 4 GHz

Input 0.1 dB Compression Point vs. Temperature @ 5V

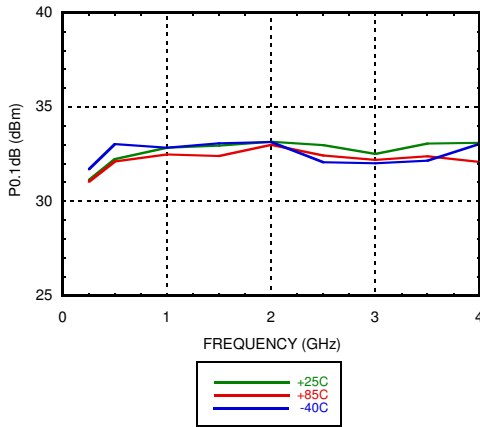

Insertion Loss Amplitude Mismatch

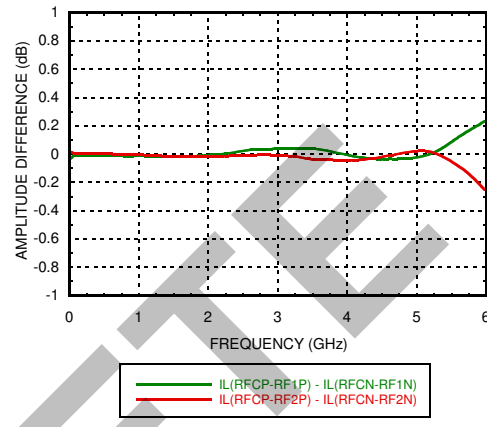

Insertion Loss Phase Mismatch

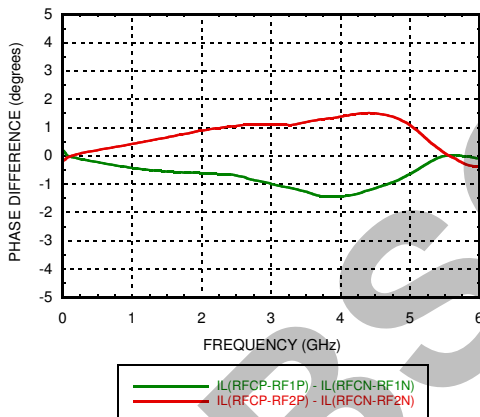

Group Delay Mismatch

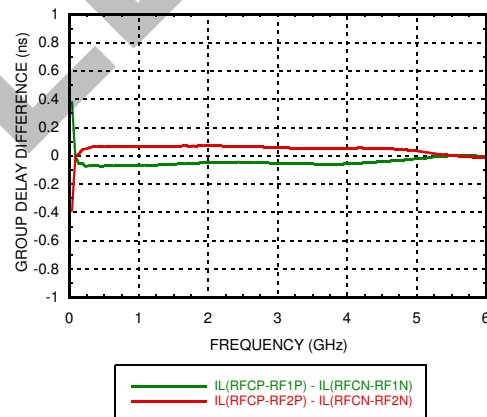

Absolute Maximum Ratings

Control Voltage (A, B)	-0.5V to 8V DC
RF Input Power	32 / 34 dBm Through Path 3V/5V Termination Path 3V/5V
Channel Temperature	150 °C
Thermal Resistance (channel to package ground paddle)	30 °C/W Through Path 79 °C/W Termination Path
Storage Temperature	-65 to +150 °C
Operating Temperature	-40 to +85 °C
ESD Sensitivity (HBM)	Class 1A

Control Voltages

State	Bias Condition
Low	0 to +0.5 Vdc @ < 1 µA Typ.
High	+3.0 to +5.5 Vdc @ 20 µA Typ.

Truth Table

	Control Input		Signal Path State	
	A	B	RFCP to:	RFNC to:
State 1	High	Low	RF1P	RF1N
State 2	Low	High	RF2P	RF2N

Do not operate continuously at RF power input greater than 1 dB compression and do not hot switch power levels greater than +27 dBm for control = 0/+3 Vdc, or +30 dBm for control = 0/+5 Vdc.



**ELECTROSTATIC SENSITIVE DEVICE
OBSERVE HANDLING PRECAUTIONS**

Information furnished by Analog Devices is believed to be accurate and reliable. However, no responsibility is assumed by Analog Devices for its use, nor for any infringements of patents or other rights of third parties that may result from its use. Specifications subject to change without notice. No license is granted by implication or otherwise under any patent or patent rights of Analog Devices. Trademarks and registered trademarks are the property of their respective owners.

For price, delivery, and to place orders: Analog Devices, Inc., One Technology Way, P.O. Box 9106, Norwood, MA 02062-9106
Phone: 781-329-4700 • Order online at www.analog.com
Application Support: Phone: 1-800-ANALOG-D



GaAs MMIC NON-REFLECTIVE DIFFERENTIAL SPDT SWITCH, DC - 4 GHz

Outline Drawing

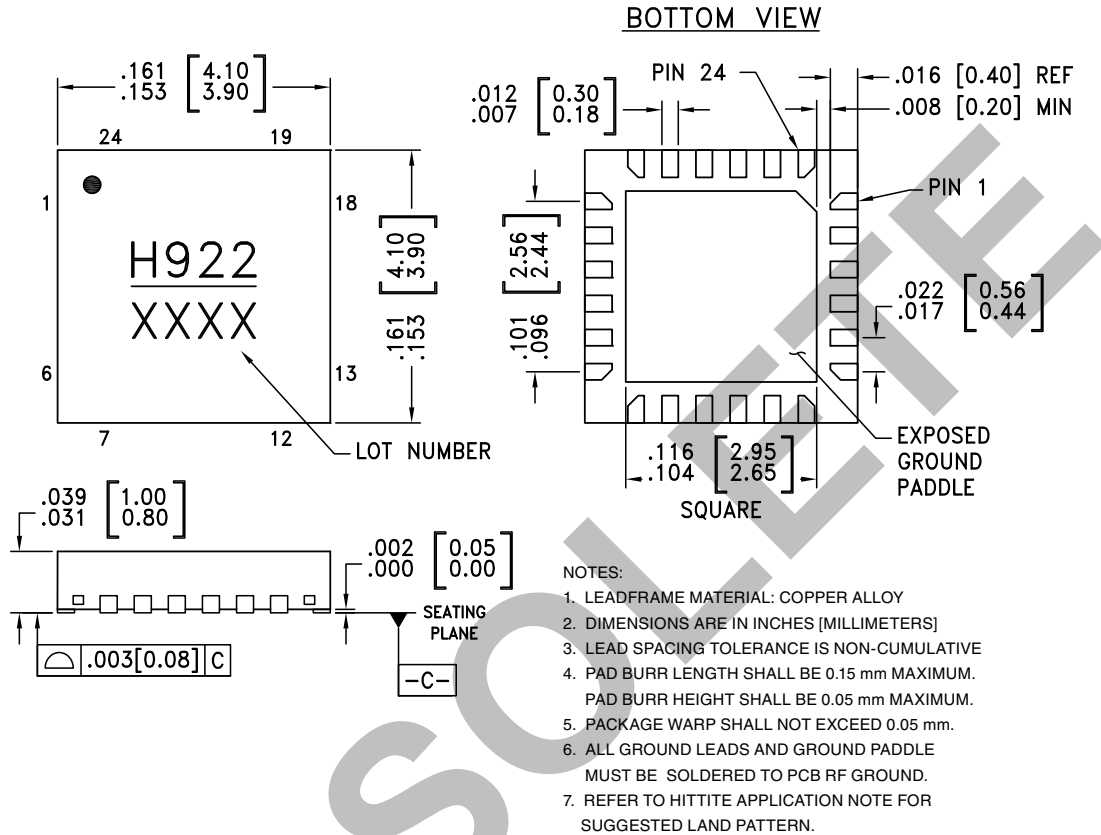

Package Information

Part Number	Package Body Material	Lead Finish	MSL Rating	Package Marking ^[1]
HMC922LP4E	RoHS-compliant Low Stress Injection Molded Plastic	100% matte Sn	MSL1 ^[2]	H922 XXXX

[1] 4-Digit lot number XXXX

[2] Max peak reflow temperature of 260 °C

Pin Descriptions

Pin Number	Function	Description	Interface Schematic
3, 4, 9, 10, 21, 22	RFCP, RFCN, RF1N, RF1P, RF2N, RF2P	These pins are DC coupled and matched to 50 Ohms. Blocking capacitors are required.	
1, 6, 7, 12, 13, 18, 19, 24	N/C	The pins are not connected internally; however, all data shown herein was measured with these pins connected to RF/DC ground externally.	
2, 5, 8, 11, 14, 17, 20, 23	GND	Package bottom has exposed metal paddle that must be connected to PCB RF ground as well.	
16	A	See truth and control voltage tables.	
15	B	See truth and control voltage tables.	

Information furnished by Analog Devices is believed to be accurate and reliable. However, no responsibility is assumed by Analog Devices for its use, nor for any infringements of patents or other rights of third parties that may result from its use. Specifications subject to change without notice. No license is granted by implication or otherwise under any patent or patent rights of Analog Devices. Trademarks and registered trademarks are the property of their respective owners.

For price, delivery, and to place orders: Analog Devices, Inc., One Technology Way, P.O. Box 9106, Norwood, MA 02062-9106 Phone: 781-329-4700 • Order online at www.analog.com Application Support: Phone: 1-800-ANALOG-D



**GaAs MMIC NON-REFLECTIVE
DIFFERENTIAL SPDT SWITCH, DC - 4 GHz**

Evaluation PCB

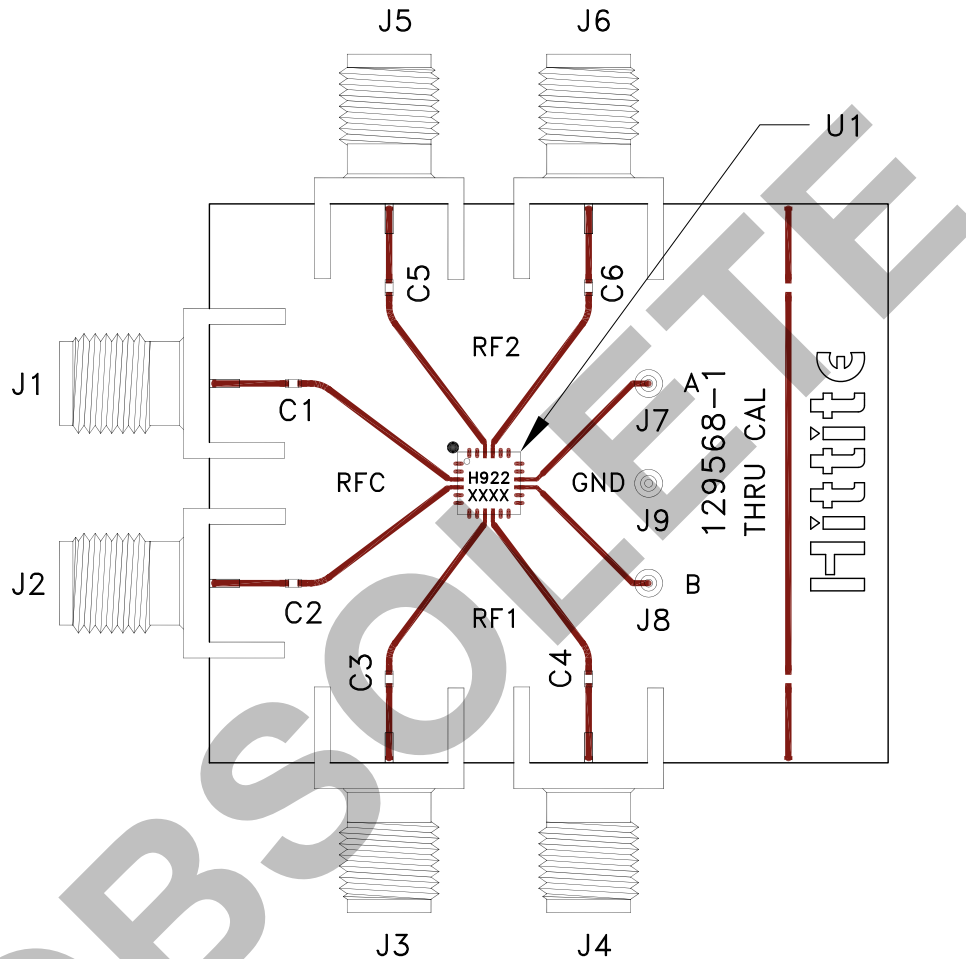

List of Materials for Evaluation PCB 129570 [1]

Item	Description
J1 - J6	PCB Mount SMA RF Connector
J7 - J9	DC Pin
C1 - C6	330 pF Capacitor, 0402 Pkg.
U1	HMC922LP4E SPDT Switch
PCB [2]	129568 Evaluation PCB

[1] Reference this number when ordering complete evaluation PCB

[2] Circuit Board Material: Rogers 4350

The circuit board used in the application should use RF circuit design techniques. Signal lines should have 50 Ohm impedance while the package ground leads and exposed paddle should be connected directly to the ground plane similar to that shown above. A sufficient number of via holes should be used to connect the top and bottom ground planes. The evaluation circuit board shown above is available from Hittite upon request.