

### LCE Series



#### Agency Approvals

AGENCY	AGENCY FILE NUMBER
	E230531

#### Maximum Ratings and Thermal Characteristics (T<sub>A</sub> = 25°C unless otherwise noted)

Parameter	Symbol	Value	Unit
Peak Pulse Power Dissipation by 10/1000µs Test Waveform (Fig.1) (Note 1)	P <sub>PPM</sub>	1500	W
Steady State Power Dissipation on Infinite Heat Sink at T <sub>L</sub> = 75°C (Fig. 5)	P <sub>D</sub>	6.5	W
Operating Junction and Storage Temperature Range	T <sub>J</sub> , T <sub>STG</sub>	-65 to 175	°C

**Note:**

1. Non-repetitive current pulse, per Fig. 3 and derated above T<sub>J</sub> (initial) = 25°C per Fig. 2.

#### Additional Information



Datasheet



Resources



Samples

#### Description

The LCE Series is designed specifically to protect sensitive electronic equipment from voltage transients induced by lightning and other transient voltage events.


#### Features

- 1500W peak pulse power capability at 10/1000µs waveform, repetition rate (duty cycles):0.01 %
- Glass passivated chip junction in DO-201 Package
- Fast response time: typically less than 1.0ps from 0 Volts to BV min
- Excellent clamping capability
- Typical failure mode is short from over-specified voltage or current
- Whisker test is conducted based on JEDEC JESD201A per its table 4a and 4c
- IEC-61000-4-2 ESD 30kV(Air), 30kV (Contact)
- ESD protection of data lines in accordance with IEC 61000-4-2
- EFT protection of data lines in accordance with IEC 61000-4-4
- Low incremental surge resistance
- High temperature to reflow soldering guaranteed: 260°C/40sec / 0.375"/(9.5mm) lead length, 5 lbs., (2.3kg) tension
- Plastic package is flammability rated V-0 per Underwriters Laboratories
- Matte tin lead-free plated
- Ideal for data line applications
- Halogen free and RoHS compliant
- Pb-free E3 means 2nd level interconnect is Pb-free and the terminal finish material is tin(Sn) (IPC/JEDEC J-STD-609A.01)

#### Applications

TVS devices are ideal for the protection of I/O interfaces, V<sub>CC</sub> bus and other vulnerable circuits used in telecom, computer, industrial and consumer electronic applications.

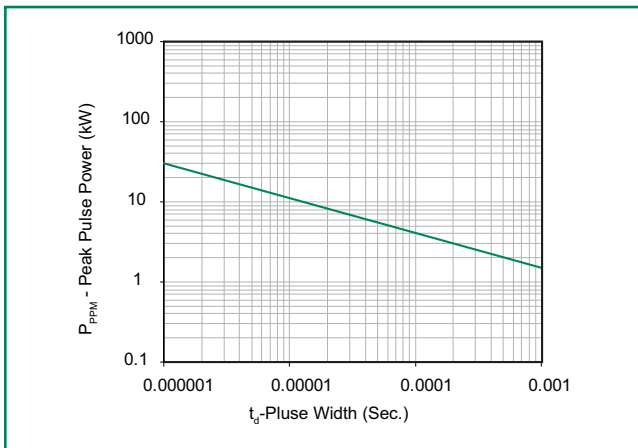
### Electrical Characteristics (T<sub>A</sub>=25°C unless otherwise noted)

Part Number	Reverse Stand off Voltage V <sub>R</sub> (V)	Breakdown Voltage V <sub>BR</sub> (V)		Test Current I <sub>T</sub> (mA)	Maximum Reverse Leakage I <sub>R</sub> @ V <sub>R</sub> (μA)	Maximum Clamping Voltage at I <sub>PP</sub> V <sub>C</sub> (V)	Maximum Peak Pulse Current (Fig.3) I <sub>PPM</sub> (A)	Maximum Junction Capacitance @ 0Volts (pF)	Working Inverse Blocking Voltage V <sub>WIB</sub> (V)	Inverse Blocking Leakage Current at I <sub>IB</sub> @ V <sub>WIB</sub> (mA)	Peak Inverse Blocking Voltage V <sub>PIB</sub> (V)	Agency Approval 
		MIN	MAX									
LCE6.5A	6.5	7.22	7.98	10	1000	11.2	100.0	100	75	1.0	100	X
LCE7.0A	7.0	7.78	8.60	10	500	12.0	100.0	100	75	1.0	100	X
LCE7.5A	7.5	8.33	9.21	10	250	12.9	100.0	100	75	1.0	100	X
LCE8.0A	8.0	8.89	9.83	1	100	13.6	100.0	100	75	1.0	100	X
LCE8.5A	8.5	9.44	10.40	1	50	14.4	100.0	100	75	1.0	100	X
LCE9.0A	9.0	10.00	11.10	1	10	15.4	97.0	100	75	1.0	100	X
LCE10A	10.0	11.10	12.30	1	5	17.0	88.0	100	75	1.0	100	X
LCE11A	11.0	12.20	13.50	1	1	18.2	82.0	100	75	1.0	100	X
LCE12A	12.0	13.30	14.70	1	1	19.9	75.0	100	75	1.0	100	X
LCE13A	13.0	14.40	15.90	1	1	21.5	70.0	100	75	1.0	100	X
LCE14A	14.0	15.60	17.20	1	1	23.2	65.0	100	75	1.0	100	X
LCE15A	15.0	16.70	18.50	1	1	24.4	61.0	100	75	1.0	100	X
LCE16A	16.0	17.80	19.70	1	1	26.0	57.0	100	75	1.0	100	X
LCE17A	17.0	18.90	20.90	1	1	27.6	54.0	100	75	1.0	100	X
LCE18A	18.0	20.00	22.10	1	1	29.2	51.0	100	75	1.0	100	X
LCE20A	20.0	22.20	24.50	1	1	32.4	46.0	100	75	1.0	100	X
LCE22A	22.0	24.40	26.90	1	1	35.5	42.0	100	75	1.0	100	X
LCE24A	24.0	26.70	29.50	1	1	38.9	39.0	100	75	1.0	100	X
LCE26A	26.0	28.90	31.90	1	1	42.1	36.0	100	75	1.0	100	X
LCE28A	28.0	31.10	34.40	1	1	45.5	33.0	100	75	1.0	100	X
LCE30A	30.0	33.30	36.80	1	1	48.4	31.0	100	75	1.0	100	X
LCE33A	33.0	36.70	40.60	1	1	53.3	28.1	100	75	1.0	100	X
LCE36A	36.0	40.00	44.20	1	1	58.1	25.8	100	75	1.0	100	X
LCE40A	40.0	44.40	49.10	1	1	64.5	23.3	100	75	1.0	100	X
LCE43A	43.0	47.80	52.80	1	1	69.4	21.6	100	75	1.0	100	X
LCE45A	45.0	50.00	55.30	1	1	72.7	20.6	100	75	1.0	100	X
LCE48A	48.0	53.30	58.90	1	1	77.4	19.4	100	75	1.0	100	X
LCE51A	51.0	56.70	62.70	1	1	82.4	18.2	100	75	1.0	100	X
LCE54A	54.0	60.00	66.30	1	1	87.1	17.2	100	100	1.0	125	X
LCE58A	58.0	64.40	71.20	1	1	93.6	16.0	100	100	1.0	125	X
LCE60A	60.0	66.70	73.70	1	1	96.8	15.5	100	100	1.0	125	X
LCE64A	64.0	71.10	78.60	1	1	103.0	14.6	100	100	1.0	125	X
LCE70A	70.0	77.80	86.00	1	1	113.0	13.3	100	125	1.0	150	X
LCE75A	75.0	83.30	92.10	1	1	121.0	12.4	100	125	1.0	150	X
LCE85A	85.0	94.40	104.00	1	1	129.0	11.6	100	125	1.0	150	X
LCE90A	90.0	100.00	111.00	1	1	146.0	10.3	100	125	1.0	150	X

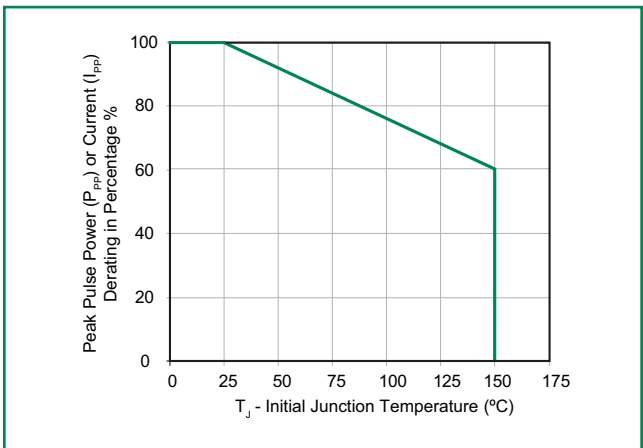
**Note:** For parts without A, the V<sub>BR</sub> is ±10% and V<sub>C</sub> is 5% higher than with A parts.

### Ratings and Characteristic Curves ( $T_A=25^\circ\text{C}$ unless otherwise noted)

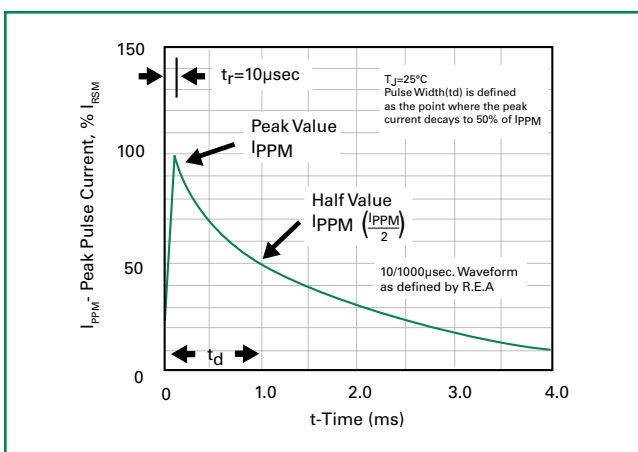
**Figure 1 - Peak Pulse Power Rating**



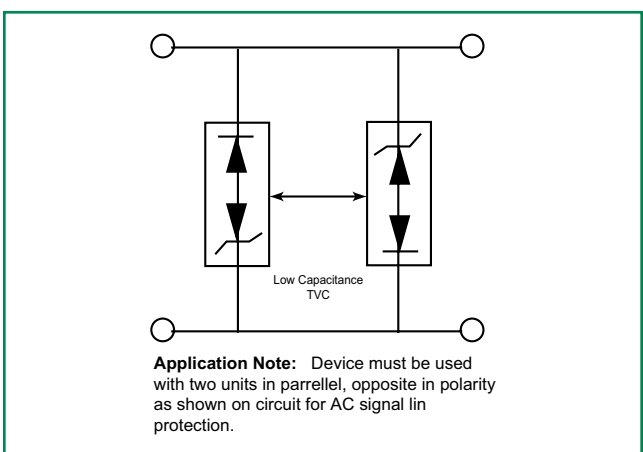
**Figure 2 - Peak Pulse Power Derating Curve**



**Figure 3 - Pulse Waveform**

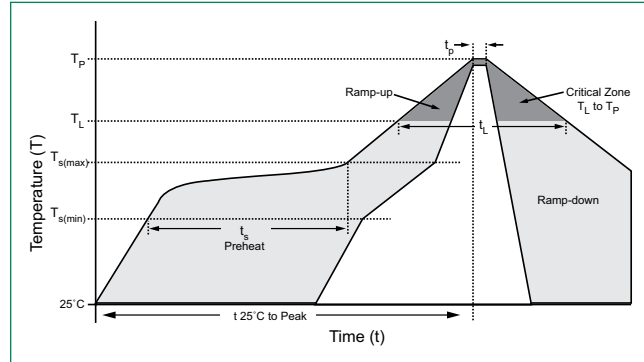


**Figure 4 - AC Line Protection Application**



### Soldering Parameters

Reflow Condition		Lead-free assembly
Pre Heat	- Temperature Min ( $T_{s(min)}$ )	150°C
	- Temperature Max ( $T_{s(max)}$ )	200°C
	- Time (min to max) ( $t_s$ )	60 – 180 secs
Average ramp up rate (Liquidus Temp ( $T_A$ ) to peak)		3°C/second max
$T_{s(max)}$ to $T_A$ - Ramp-up Rate		3°C/second max
Reflow	- Temperature ( $T_A$ ) (Liquidus)	217°C
	- Time (min to max) ( $t_s$ )	60 – 150 seconds
Peak Temperature ( $T_p$ )		260 <sup>+0/-5</sup> °C
Time within 5°C of actual peak Temperature ( $t_p$ )		20 – 40 seconds
Ramp-down Rate		6°C/second max
Time 25°C to peak Temperature ( $T_p$ )		8 minutes Max.
Do not exceed		260°C



### Flow/Wave Soldering (Solder Dipping)

<b>Peak Temperature :</b>	265°C
<b>Dipping Time :</b>	10 seconds
<b>Soldering :</b>	1 time

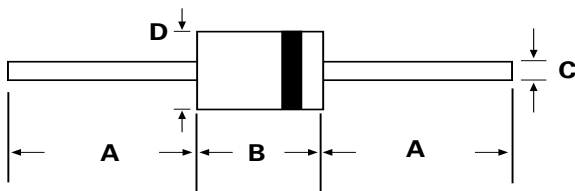
### Physical Specifications

<b>Weight</b>	0.045oz., 1.2g
<b>Case</b>	JEDEC DO-201 molded plastic body over passivated junction.
<b>Polarity</b>	Color band denotes the cathode except Bipolar.
<b>Terminal</b>	Matte Tin axial leads, solderable per JESD22-B102.

### Environmental Specifications

<b>High Temp. Storage</b>	JESD22-A103
<b>HTRB</b>	JESD22-A108
<b>Temperature Cycling</b>	JESD22-A104
<b>H3TRB</b>	JESD22-A101
<b>RSH</b>	JESD22-B106

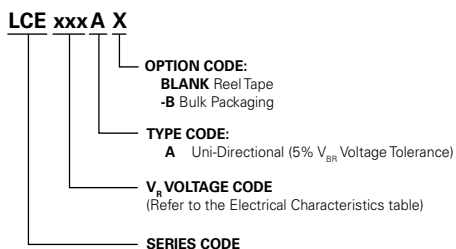
### Dimensions



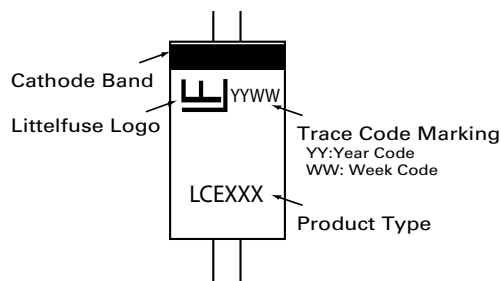
DO-201

Dimensions	Inches		Millimeters	
	Min	Max	Min	Max
A	1.000	-	25.40	-
B	0.285	0.375	7.20	9.50
C	0.038	0.042	0.96	1.07
D	0.190	0.210	4.80	5.30

### Part Numbering System



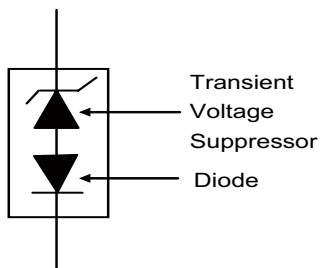
### Part Marking System



### Packaging

Part Number	Component Package	Quantity	Packaging Option	Packaging Specification
LCExxxXX	DO-201	1200	Tape & Reel	EIA STD RS-296
LCExxxXX-B	DO-201	500	BULK	Littelfuse Spec.

### Schematic



### Tape and Reel Specification

