

N-Channel Power MOSFET

150V, 1.4A, 480mΩ

FEATURES

- Low $R_{DS(on)}$ to minimize conductive losses
- Low gate charge for fast power switching
- Compliant to RoHS directive 2011/65/EU and in accordance to WEEE 2002/96/EC
- Halogen-free according to IEC 61249-2-21

KEY PERFORMANCE PARAMETERS

PARAMETER	VALUE	UNIT
V_{DS}	150	V
$R_{DS(on)}$ (max)	$V_{GS} = 10V$	480
	$V_{GS} = 6V$	520
Q_g	8	nC

APPLICATIONS

- Battery Management System
- LED Lighting



SOT-26

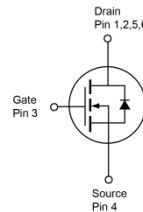
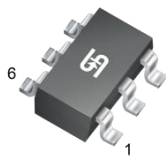

Note: MSL 3 (Moisture Sensitivity Level) per J-STD-020

ABSOLUTE MAXIMUM RATINGS ($T_A = 25^\circ\text{C}$ unless otherwise noted)

PARAMETER	SYMBOL	LIMIT	UNIT
Drain-Source Voltage	V_{DS}	150	V
Gate-Source Voltage	V_{GS}	± 20	V
Continuous Drain Current (Note 1)	I_D	$T_C = 25^\circ\text{C}$	1.4
		$T_A = 25^\circ\text{C}$	1.1
Pulsed Drain Current	I_{DM}	5.6	A
Total Power Dissipation	P_D	$T_C = 25^\circ\text{C}$	2.1
		$T_C = 125^\circ\text{C}$	0.4
Total Power Dissipation	P_D	$T_A = 25^\circ\text{C}$	1.5
		$T_A = 125^\circ\text{C}$	0.3
Operating Junction and Storage Temperature Range	T_J, T_{STG}	- 55 to +150	$^\circ\text{C}$

THERMAL PERFORMANCE

PARAMETER	SYMBOL	LIMIT	UNIT
Junction to Case Thermal Resistance	$R_{\theta JC}$	59	$^\circ\text{C/W}$
Junction to Ambient Thermal Resistance	$R_{\theta JA}$	83	$^\circ\text{C/W}$

Thermal Performance Note: $R_{\theta JA}$ is the sum of the junction-to-case and case-to-ambient thermal resistances. The case-thermal reference is defined at the solder mounting surface of the drain pins. $R_{\theta JA}$ is guaranteed by design while $R_{\theta CA}$ is determined by the user's board design.

ELECTRICAL SPECIFICATIONS ($T_A = 25^\circ\text{C}$ unless otherwise noted)						
PARAMETER	CONDITIONS	SYMBOL	MIN	TYP	MAX	UNIT
Static						
Drain-Source Breakdown Voltage	$V_{GS} = 0V, I_D = 250\mu A$	BV_{DSS}	150	--	--	V
Gate Threshold Voltage	$V_{GS} = V_{DS}, I_D = 250\mu A$	$V_{GS(TH)}$	2	2.9	3.5	V
Gate Threshold Voltage Temperature Coefficient	$I_D = 250\mu A$	$\frac{\Delta V_{GS(TH)}}{\Delta T_J}$	--	-6.4	--	mV/ $^\circ\text{C}$
Gate-Source Leakage Current	$V_{GS} = \pm 20V, V_{DS} = 0V$	I_{GSS}	--	--	± 100	nA
Drain-Source Leakage Current	$V_{GS} = 0V, V_{DS} = 150V$	I_{DSS}	--	--	1	μA
	$V_{GS} = 0V, V_{DS} = 150V$ $T_J = 125^\circ\text{C}$		--	--	100	
Drain-Source On-State Resistance (Note 2)	$V_{GS} = 10V, I_D = 1.1A$	$R_{DS(on)}$	--	392	480	m Ω
	$V_{GS} = 6V, I_D = 1.1A$		--	428	520	
Forward Transconductance (Note 2)	$V_{DS} = 5V, I_D = 1.1A$	g_{fs}	--	3.3	--	S
Dynamic (Note 3)						
Total Gate Charge	$V_{GS} = 10V, V_{DS} = 10V,$ $I_D = 1.1A$	Q_g	--	8	--	nC
Total Gate Charge	$V_{GS} = 6V, V_{DS} = 10V,$ $I_D = 1.1A$	Q_g	--	5	--	
Gate-Source Charge		Q_{gs}	--	2	--	
Gate-Drain Charge		Q_{gd}	--	2.7	--	
Input Capacitance	$V_{GS} = 0V, V_{DS} = 10V$ $f = 1.0\text{MHz}$	C_{iss}	--	332	--	pF
Output Capacitance		C_{oss}	--	20	--	
Reverse Transfer Capacitance		C_{rss}	--	1	--	
Gate Resistance	$f = 1.0\text{MHz}$	R_g	--	3.5	--	Ω
Switching (Note 3)						
Turn-On Delay Time	$V_{GS} = 10V, V_{DS} = 10V,$ $I_D = 1.1A, R_G = 2\Omega,$	$t_{d(on)}$	--	5	--	ns
Turn-On Rise Time		t_r	--	18	--	
Turn-Off Delay Time		$t_{d(off)}$	--	9	--	
Turn-Off Fall Time		t_f	--	18	--	
Source-Drain Diode						
Forward Voltage (Note 2)	$V_{GS} = 0V, I_S = 1.1A$	V_{SD}	--	--	1.2	V
Reverse Recovery Time	$I_S = 1.1A,$ $di/dt = 100A/\mu s$	t_{rr}	--	51	--	ns
Reverse Recovery Charge		Q_{rr}	--	59	--	nC

Notes:

1. Silicon limited current only.
2. Pulse test: Pulse Width $\leq 300\mu s$, duty cycle $\leq 2\%$.
3. Switching time is essentially independent of operating temperature.

ORDERING INFORMATION

PART NO.	PACKAGE	PACKING
TSM4800N15CX6 RFG	SOT-26	3,000pcs / 7" Reel

CHARACTERISTICS CURVES

($T_A = 25^\circ\text{C}$ unless otherwise noted)

Output Characteristics

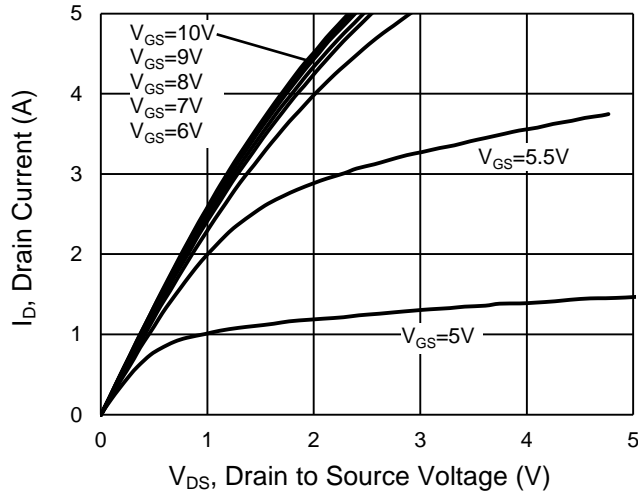

Transfer Characteristics

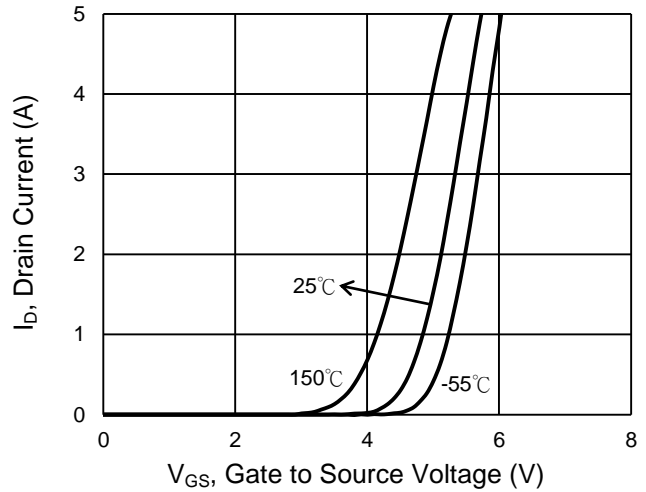

On-Resistance vs. Drain Current

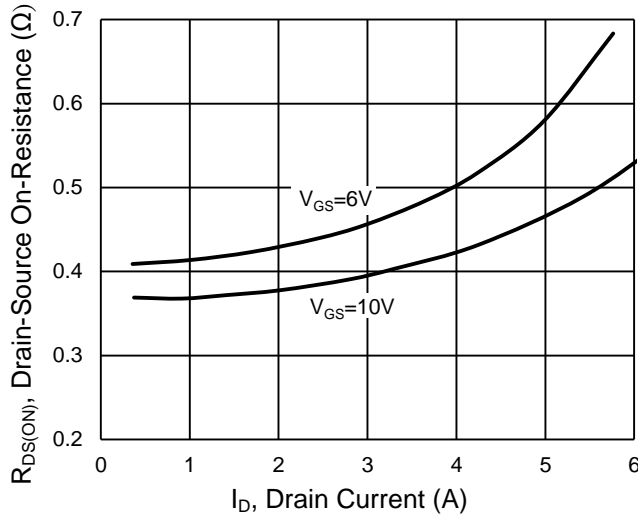

Gate-Source Voltage vs. Gate Charge

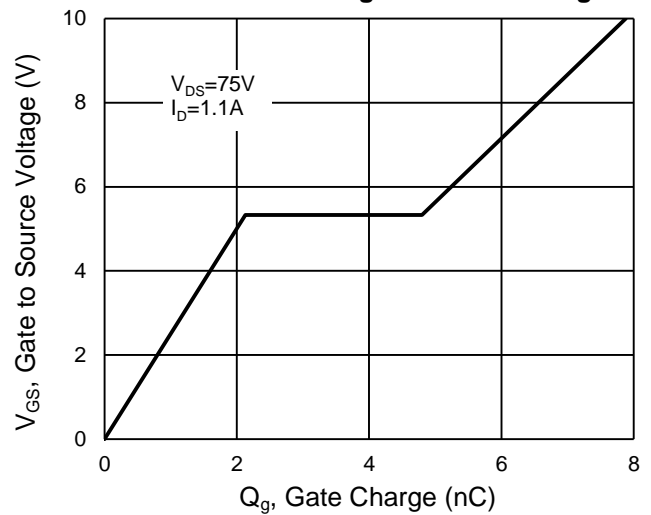

On-Resistance vs. Junction Temperature

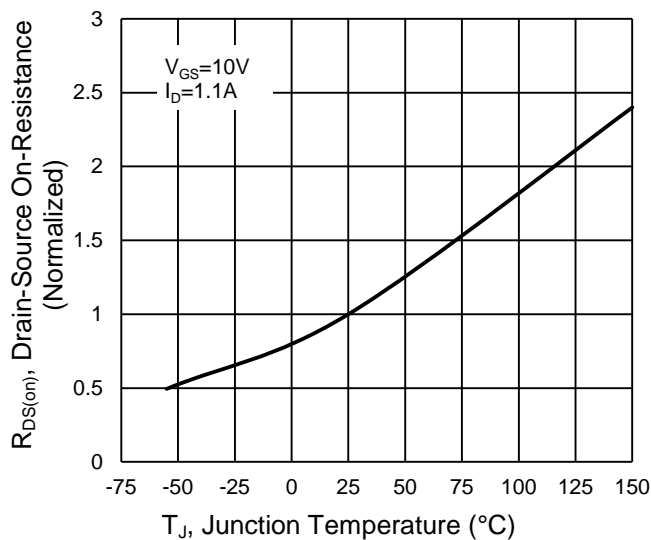

On-Resistance vs. Gate-Source Voltage

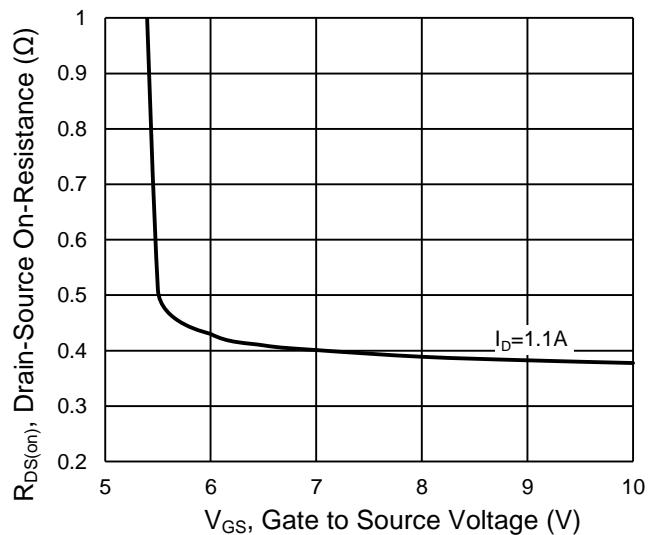

CHARACTERISTICS CURVES

($T_A = 25^\circ\text{C}$ unless otherwise noted)

Capacitance vs. Drain-Source Voltage

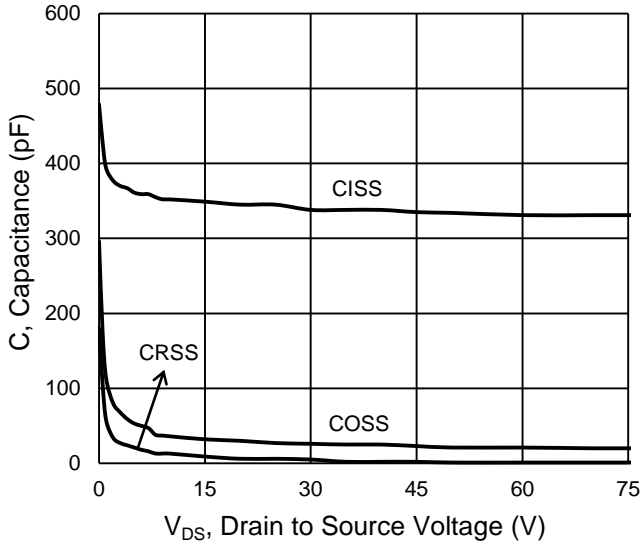

BV_{DSS} vs. Junction Temperature

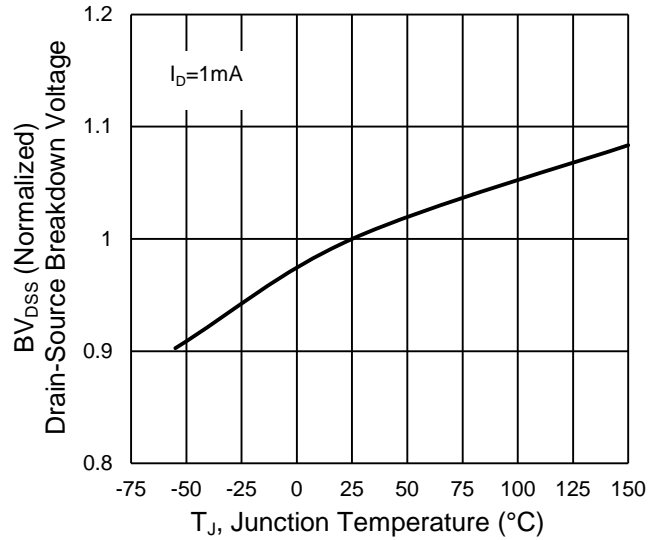

Maximum Safe Operating Area, Junction-to-Case

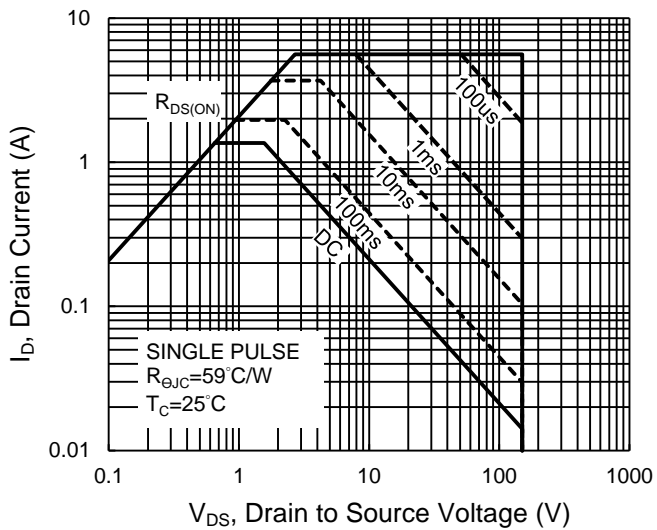

Source-Drain Diode Forward Current vs. Voltage

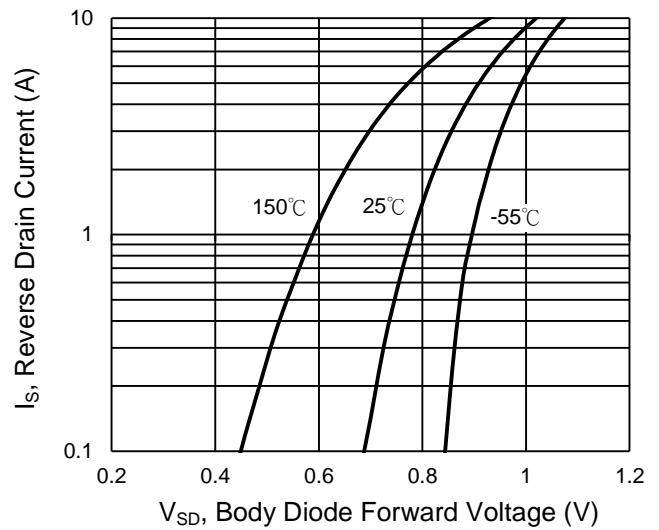

Normalized Thermal Transient Impedance, Junction-to-Case

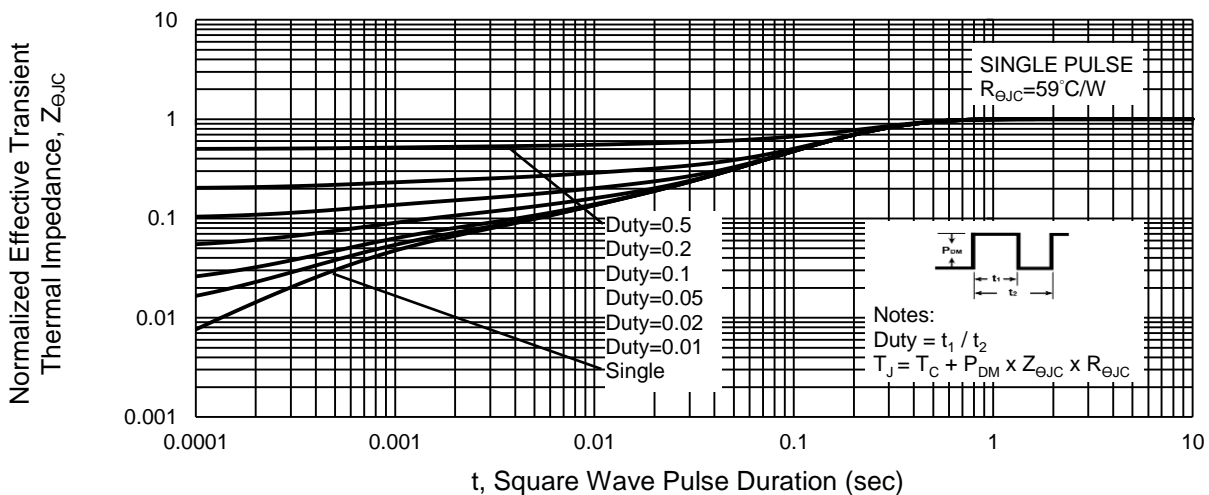

PACKAGE OUTLINE DIMENSIONS (Unit: Millimeters)

SOT-26

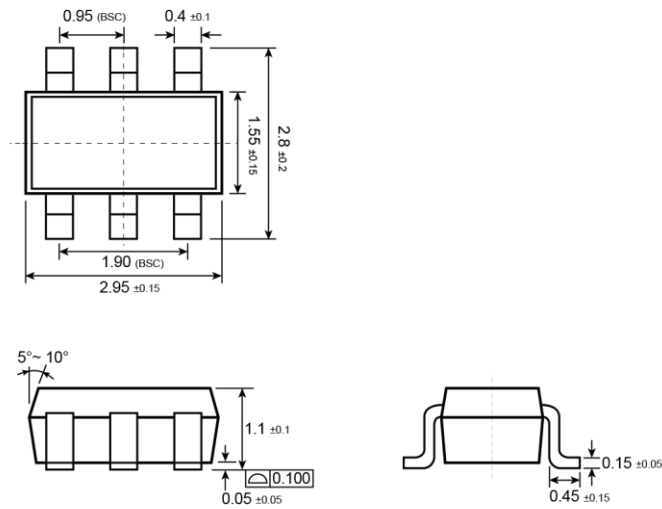

SUGGESTED PAD LAYOUT (Unit: Millimeters)

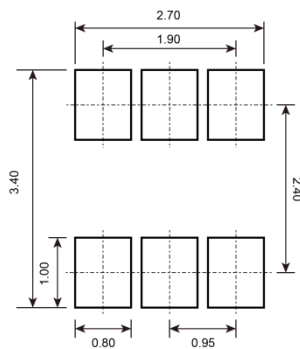

MARKING DIAGRAM

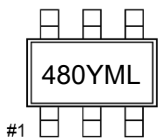

480 = Device Code

Y = Year Code

M = Month Code

O =Jan **P** =Feb **Q** =Mar **R** =Apr

S =May **T** =Jun **U** =Jul **V** =Aug

W =Sep **X** =Oct **Y** =Nov **Z** =Dec

L = Lot Code

Notice

Specifications of the products displayed herein are subject to change without notice. TSC or anyone on its behalf, assumes no responsibility or liability for any errors or inaccuracies.

Information contained herein is intended to provide a product description only. No license, express or implied, to any intellectual property rights is granted by this document. Except as provided in TSC's terms and conditions of sale for such products, TSC assumes no liability whatsoever, and disclaims any express or implied warranty, relating to sale and/or use of TSC products including liability or warranties relating to fitness for a particular purpose, merchantability, or infringement of any patent, copyright, or other intellectual property right.

The products shown herein are not designed for use in medical, life-saving, or life-sustaining applications. Customers using or selling these products for use in such applications do so at their own risk and agree to fully indemnify TSC for any damages resulting from such improper use or sale.