

MAX19005

Quad, Ultra-Low-Power, 200Mbps ATE Drivers/Comparators

General Description

The MAX19005 four-channel, ultra-low-power, pin-electronics IC includes a two-level pin driver, a window comparator, a passive load, and force-and-sense Kelvin-switched parametric measurement unit (PMU) connections for each channel. The driver features a -1V to +5.2V voltage range, includes high-impedance modes, and is highly linear even at low voltage swings. The window comparator features 240MHz equivalent input bandwidth and programmable output voltage levels. The passive load provides pullup and pulldown voltages to the device-under-test (DUT).

Low leakage and high impedance are operational configurations that are programmed through a 3-wire, low-voltage, CMOS-compatible serial interface. High-speed PMU switching is realized through dedicated digital control inputs.

This device is available in an 80-pin, 12mm x 12mm body, 0.5mm pitch TQFP with an exposed 6mm x 6mm die pad on the bottom of the package for efficient heat removal. The device is specified to operate over the 0°C to +70°C commercial temperature range and features a die temperature monitor output.

Ordering Information appears at end of data sheet.

Features

- ◆ **Small Footprint: Four Channels in 0.3in²**
- ◆ **Low-Power Dissipation: 340mW/Channel (typ)**
- ◆ **High Speed: 200Mbps at 3V_{p-p}**
- ◆ **-1V to +5.2V Operating Range**
- ◆ **Integrated Pin Switch (with -1V to +24V Off Range)**
- ◆ **Integrated PMU Switches with -1V to +24V Operating Range**
- ◆ **Passive Load**
- ◆ **Low-Leakage Mode by Pin Switch Off: 10nA (max)**
- ◆ **Low Gain and Offset Error**

Applications

NAND Flash Testers
DRAM Probe Testers
Low-Cost Mixed-Signal/System-on-Chip (SoC) Testers
Active Burn-In Systems
Structural Testers

For related parts and recommended products to use with this part, refer to: www.maxim-ic.com/MAX19005.related

Quad, Ultra-Low-Power, 200Mbps ATE Drivers/Comparators

ABSOLUTE MAXIMUM RATINGS

V _{DD} to GND.....	-0.3V to +9.4V
V _{SS} to GND	-6.25V to +0.3V
V _{DD} - V _{SS}	+15.65V
V _L to GND	-0.3V to +5V
DHV ₋ , DLV ₋ to GND with Integrated Pin Switch Off	V _{SS} - 0.3V to V _{DD} + 0.3V
DHV ₋ , DLV ₋ to GND with Integrated Pin Switch On	V _{SSSW} - 0.3V to V _{DD} + 0.3V
DATA ₋ , RCV ₋ , V _{BBI} to GND.....	-0.3V to +5V
LDV ₋ to GND.....	V _{SSSW} - 0.3V to V _{DD} + 0.3V
CHV ₋ , CLV ₋ , COMPHI, COMPL0 to GND.....	V _{SS} - 0.3V to V _{DD} + 0.3V
CMPL ₋ , CMPL ₋ , V _{BBO} to GND	-0.3V to V _{DD}
LD, DIN, SCLK, CS, SWEN to GND	-0.3V to +V _L
CHV ₋ , CLV ₋ to DUT ₋ with Integrated Pin Switch On.....	8V
DUT ₋ to GND with Integrated Pin Switch Off...V _{SSSW} to V _{DDSW}	
DUT ₋ to GND with Integrated Pin Switch On.....	V _{SSSW} to V _{DD}
FORCE, SENSE, PMU ₋ to GND	V _{SSSW} to V _{DDSW}
V _{DDSW} to V _{SSSW}	+27V

V _{DDSW} to V _{SS}	+31.35V
V _{DDSW} to GND.....	-0.3V to +26.1V
V _{SSSW} to GND.....	-2.4V to +0.3V
DUT ₋ , CMPH ₋ , CMPL ₋ Short-Circuit Duration.....	Continuous
DOUT to GND	-0.3V to +V _L
TEMP to GND	-0.3V to V _{DD}
TEMP Short-Circuit Duration	Continuous
PMU Force Switch Continuous Current	±35mA
PMU Force Switch Peak Current.....	±160mA
PMU Sense Switch Continuous Current.....	±1mA
PMU Sense Switch Peak Current.....	±30mA
All Digital Inputs	±30mA
Continuous Power Dissipation (T _A = +70°C)	
TQFP (derate 35.7mW/°C above +70°C)	2857mW
Storage Temperature Range.....	-65°C to +150°C
Junction Temperature	+150°C
Lead Temperature (soldering, 10s)	+300°C
Soldering Temperature (reflow)	+260°C

Stresses beyond those listed under "Absolute Maximum Ratings" may cause permanent damage to the device. These are stress ratings only, and functional operation of the device at these or any other conditions beyond those indicated in the operational sections of the specifications is not implied. Exposure to absolute maximum rating conditions for extended periods may affect device reliability.

ELECTRICAL CHARACTERISTICS

(V_{DD} = +8V, V_{SS} = -5V, V_L = +3V, V_{DDSW} = +24.6V, V_{SSSW} = -1.25V, V_{COMP} = +1V, V_{COMPL0} = 0V, V_{LDV₋} = 0V, LOAD EN LOW₋ = LOAD EN HIGH₋ = 0, SWEN = 1, T_J = +70°C with an accuracy of ±15°C. Specification compliance with supply and temperature variations is verified by guard-banding mean shifts of characterization data, unless otherwise noted. All temperature coefficients measured at T_J = +50°C to +90°C, unless otherwise noted.) (Note 1)

PARAMETER	SYMBOL	CONDITIONS	MIN	TYP	MAX	UNITS
DRIVER (all specifications apply when DUT₋ = DHV₋ or DUT₋ = DLV₋)						
DC CHARACTERISTICS (R_{DUT₋} ≥ 10MΩ, unless otherwise noted)						
Voltage Range			-1.0		+5.2	V
Gain		Measured at 0V and +3V	0.995	1	1.005	V/V
Gain Temperature Coefficient				50		ppm/°C
Offset		V _{DHV₋} = +2V, V _{DLV₋} = 0V			±10	mV
Offset Temperature Coefficient		V _{DHV₋} = +1.5V		±250		μV/°C
Power-Supply Rejection Ratio	PSRR	V _{DD} , V _{SS} independently varied over full range, V _{DHV₋} = +1.5V			±18	mV/V
		V _{DDSW} , V _{SSSW} independently varied over full range, V _{DHV₋} = +1.5V			±10	mV/V
Maximum DC Drive Current	I _{DUT₋}		±40			mA
DC Output Resistance		I _{DUT₋} = ±10mA, DATA ₋ = 1, trim condition, target = 49.5Ω	47.5	49.5	51.5	Ω
DC Output Resistance (V _{DDSW} = +15V)		I _{DUT₋} = ±10mA, DATA ₋ = 1	49.0	52.0	55.0	Ω

Quad, Ultra-Low-Power, 200Mbps ATE Drivers/Comparators

ELECTRICAL CHARACTERISTICS (continued)

($V_{DD} = +8V$, $V_{SS} = -5V$, $V_L = +3V$, $V_{DDSW} = +24.6V$, $V_{SSSW} = -1.25V$, $V_{COMP HI} = +1V$, $V_{COMP LO} = 0V$, $V_{LDV_} = 0V$, $LOAD\ EN\ LOW_ = LOAD\ EN\ HIGH_ = 0$, $SWEN = 1$, $T_J = +70^\circ C$ with an accuracy of $\pm 15^\circ C$. Specification compliance with supply and temperature variations is verified by guard-banding mean shifts of characterization data, unless otherwise noted. All temperature coefficients measured at $T_J = +50^\circ C$ to $+90^\circ C$, unless otherwise noted.) (Note 1)

PARAMETER	SYMBOL	CONDITIONS	MIN	TYP	MAX	UNITS
DC Output Resistance Variation		$I_{DUT_} = -40mA$ to $+40mA$, $DATA_ = 1$ (Note 2)			5.0	Ω
DC Output Resistance Variation ($V_{DDSW} = +15V$)		$I_{DUT_} = -40mA$ to $+40mA$, $DATA_ = 1$ (Note 2)			8.0	Ω
DC Crosstalk, $DHV_ \text{ to } DLV_$, $DLV_ \text{ to } DHV_$		$V_{DLV_} = +1.5V$, $V_{DHV_} = -1V, +5.2V$			± 5	mV
		$V_{DHV_} = +1.5V$, $V_{DLV_} = -1V, +5.2V$			± 5	
Linearity Error		+1.5V (Note 3)			± 5	mV
		-1V and +5.2V (Note 3)			± 15	
AC CHARACTERISTICS ($R_{DUT_} = 50\Omega$ to GND, unless otherwise noted) (Note 4)						
Dynamic Output Current		(Note 5)		± 60		mA
Drive Mode Overshoot, Undershoot, and Preshoot		+0.2V to $4V_{P-P}$ swing (Note 6)		5% + 10		mV
High-Impedance Mode Spike		$DHV_/high-Z$, $V_{DLV_} = -1V$, $V_{DHV_} = 0V$		25		mV
		$DLV_/high-Z$, $V_{DLV_} = 0V$, $V_{DHV_} = +1V$		25		
Propagation Delay, Data to Output		$V_{DHV_} = +3V$, $V_{DLV_} = 0V$, average of t_{LH} and t_{HL}	2.5	3.5	5.1	ns
Propagation Delay Temperature Coefficient		$V_{DHV_} = +3V$, $V_{DLV_} = 0V$		1		ps/ $^\circ C$
Propagation Delay Match, t_{LH} vs. t_{HL}		$V_{DHV_} = +3V$, $V_{DLV_} = 0V$		70		ps
Propagation Delay Skew, Drivers Within Package		$V_{DHV_} = +3V$, $V_{DLV_} = 0V$		100		ps
Propagation Delay Change vs. Pulse Width		Relative to 12.5ns pulse	$3V_{P-P}$, 40MHz, PW = 4ns to 21ns		± 40	ps
			$1V_{P-P}$, 40MHz, PW = 2.5ns to 22.5ns		± 90	
Propagation Delay Change vs. Common-Mode Voltage		$1V_{P-P}$, $V_{DLV_} = 0V$ to $+3V$, relative to delay at $V_{DLV_} = +1V$		± 80		ps
Propagation Delay, Drive to High Impedance, High Impedance to Drive		$V_{DHV_} = +1.5V$, $V_{DLV_} = -1V$, average of both directions of t_{LH} and t_{HL}		3.9		ns
Minimum Voltage Swing		(Note 7)		100		mV

Quad, Ultra-Low-Power, 200Mbps ATE Drivers/Comparators

ELECTRICAL CHARACTERISTICS (continued)

($V_{DD} = +8V$, $V_{SS} = -5V$, $V_L = +3V$, $V_{DDSW} = +24.6V$, $V_{SSSW} = -1.25V$, $V_{COMPHI} = +1V$, $V_{COMPLO} = 0V$, $V_{LDV_} = 0V$, $LOAD\ EN\ LOW_ = LOAD\ EN\ HIGH_ = 0$, $SWEN = 1$, $T_J = +70^\circ C$ with an accuracy of $\pm 15^\circ C$. Specification compliance with supply and temperature variations is verified by guard-banding mean shifts of characterization data, unless otherwise noted. All temperature coefficients measured at $T_J = +50^\circ C$ to $+90^\circ C$, unless otherwise noted.) (Note 1)

PARAMETER	SYMBOL	CONDITIONS	MIN	TYP	MAX	UNITS
Rise/Fall Time (Average Rise/Fall Time)		$V_{DHFV_} = +0.2V$, $V_{DLV_} = 0V$, 20% to 80%		0.8		ns
		$V_{DHFV_} = +1V$, $V_{DLV_} = 0$, 20% to 80%		0.8		
		$V_{DHFV_} = +3V$, $V_{DLV_} = 0V$, 10% to 90%	1.4	2.0	2.7	
		$V_{DHFV_} = +4V$, $V_{DLV_} = 0V$, $R_{DUT_} = 500\Omega$, 10% to 90%		2.5		
		$V_{DHFV_} = +5V$, $V_{DLV_} = 0V$, $R_{DUT_} = 500\Omega$, 10% to 90%		3.1		
Rise/Fall Time Matching		$V_{DHFV_} = +0.2V$		± 50		%
		$V_{DHFV_} = +1V$	$V_{DLV_} = 0V$	± 15		
		$V_{DHFV_} = +3V$ and $+5V$		± 5		
Minimum Pulse Width (Average Positive/Negative Pulse) (Note 8)		$0.2V_{P-P}$, $V_{DHFV_} = +0.2V$, $V_{DLV_} = 0V$		1.8		ns
		$1V_{P-P}$, $V_{DHFV_} = +1V$, $V_{DLV_} = 0V$		2.0		
		$3V_{P-P}$, $V_{DHFV_} = +3V$, $V_{DLV_} = 0V$		2.6		
COMPARATOR (driver in high-impedance mode) (Note 9)						
DC CHARACTERISTICS						
Input Voltage Range			-1.0		+5.2	V
Differential Input Voltage		$V_{DUT_} - V_{CHV_}$, $V_{DUT_} - V_{CLV_}$	-6.2		+6.2	V
Hysteresis		$V_{CHV_} = V_{CLV_} = +1.5V$		8		mV
Input Offset Voltage		$V_{DUT_} = +1.5V$, $V_{COMPHI} = +0.8V$, $V_{COMPLO} = +0.2V$ (Note 10)			± 10	mV
Input Offset Temperature Coefficient		(Note 10)		± 25		$\mu V/^\circ C$
Common-Mode Rejection Ratio	CMRR	$V_{DUT_} = 0V$ and $+3V$ (Note 10)	60			dB
Linearity Error		$V_{DUT_} = +1.5V$ (Notes 3, 10)			± 5	mV
		$V_{DUT_} = -1V$, $+5.2V$ (Notes 3, 10)			± 10	
Power-Supply Rejection Ratio	PSRR	$V_{DUT_} = +1.5V$, V_{DD} , V_{SS} , V_{DDSW} , V_{SSSW} supplies independently varied over full range (Note 10)			± 5	mV/V
AC CHARACTERISTICS (Note 11)						
Equivalent Input Bandwidth		$V_{DLV_} = 0V$ termination mode, $V_{DUT_} = 1V_{P-P}$, $t_R = t_F = 500ps$ input, calculated from 10% to 90% redigitization waveform		300		MHz
Prop Delay		$V_{DUT_} = 1V_{P-P}$, $V_{CHV_}$ or $V_{CLV_} = +0.5V$	1.1	2.0	3.3	ns
Prop-Delay Temperature Coefficient		$V_{DUT_} = 1V_{P-P}$, $V_{CHV_}$ or $V_{CLV_} = +0.5V$		2		ps/ $^\circ C$
Prop-Delay Match, t_{LH} to t_{HL}		Absolute value of delta for each comparator, $V_{DUT_} = 1V_{P-P}$		± 250		ps

Quad, Ultra-Low-Power, 200Mbps ATE Drivers/Comparators

ELECTRICAL CHARACTERISTICS (continued)

($V_{DD} = +8V$, $V_{SS} = -5V$, $V_L = +3V$, $V_{DDSW} = +24.6V$, $V_{SSSW} = -1.25V$, $V_{COMPHI} = +1V$, $V_{COMPLO} = 0V$, $V_{LDV_} = 0V$, $LOAD\ EN\ LOW_ = LOAD\ EN\ HIGH_ = 0$, $SWEN = 1$, $T_J = +70^\circ C$ with an accuracy of $\pm 15^\circ C$. Specification compliance with supply and temperature variations is verified by guard-banding mean shifts of characterization data, unless otherwise noted. All temperature coefficients measured at $T_J = +50^\circ C$ to $+90^\circ C$, unless otherwise noted.) (Note 1)

PARAMETER	SYMBOL	CONDITIONS	MIN	TYP	MAX	UNITS
Prop-Delay Skew, Comparators Within Package		Same edges (LH and HL), $V_{DUT_} = 1V_{P-P}$		± 100		ps
Prop-Delay Dispersions vs. Common-Mode Voltage (Note 12)		$V_{CHV_}$ or $V_{CLV_} = 0$ to $+4.9V$, $V_{DUT_} = 0.2V_{P-P}$		± 20		ps
		$V_{CHV_}$ or $V_{CLV_} = -0.9$ to $+4.9V$, $V_{DUT_} = 0.2V_{P-P}$		± 30		
Prop-Delay Dispersions vs. Overdrive		$V_{DLV_} = 0V$ termination mode, $V_{DUT_} = 1V_{P-P}$, $t_R = t_F = 500ps$ input, 90% (rising edge) and 10% (falling edge) relative to timing at 50% point		± 600		ps
Prop-Delay Dispersions vs. Pulse Width		2ns to 23ns pulse width, relative to 12.5ns pulse width		± 60		ps
Prop-Delay Dispersions vs. Slew Rate		$+0.5V/ns$ to $+2V/ns$		± 50		ps
LOGIC INPUTS AND OUTPUTS (COMPHI, COMPLO, CMPH_, CMPL_, VBBO)						
Input Voltage Range, V_{COMPHI} and V_{COMPLO}			0		3.6	V
Differential Input Voltage, $V_{COMPHI} - V_{COMPLO}$		$V_{COMPHI} \geq V_{COMPLO}$, $CMPH_ and CMPL_ with no load$	0		3.6	V
Differential Input Voltage, $V_{COMPHI} - V_{COMPLO}$		$V_{COMPHI} \geq V_{COMPLO}$, $CMPH_ and CMPL_ with 50\Omega$ to V_{TTCMP} , $V_{COMPHI} \geq V_{TTCMP} \geq V_{COMPLO}$	0		1.0	V
Reference Output, V_{BBO}		Relative to $(V_{COMPHI} + V_{COMPLO})/2$ at $V_{COMPHI} = +1V$ and $V_{COMPLO} = 0V$			± 50	mV
Output High-Voltage Offset		$I_{OUT} = 0mA$, relative to V_{COMPHI} at $V_{COMPHI} = +1V$			± 65	mV
Output Low-Voltage Offset		$I_{OUT} = 0mA$, relative to V_{COMPLO} at $V_{COMPLO_} = 0V$			± 65	mV
Output Resistance, $CMPH_ and CMPL_$		$I_{CMPH_} = I_{CMPL_} = \pm 10mA$, $V_{COMPHI} = +1V$, $V_{COMPLO} = 0V$, $CMPH_ , CMPL_ at high-level output$	40	50	60	Ω
Maximum Current Limit, $CMPH_ and CMPL_$		$V_{COMPHI} = +1.8V$, $V_{COMPLO} = 0V$, $CMPH_ , CMPL_ at high-level output$, $V_{FORCE} = 0V, +3.6V$	-15		+15	mA
Maximum Current Limit, V_{BBO}		$V_{COMPHI} = +1V$, $V_{COMPLO} = 0V$, at $V_{BBO} = +0.5V$ output	-1		+1	mA

Quad, Ultra-Low-Power, 200Mbps ATE Drivers/Comparators

ELECTRICAL CHARACTERISTICS (continued)

($V_{DD} = +8V$, $V_{SS} = -5V$, $V_L = +3V$, $V_{DDSW} = +24.6V$, $V_{SSSW} = -1.25V$, $V_{COMPHI} = +1V$, $V_{COMPLO} = 0V$, $V_{LDV_} = 0V$, $LOAD\ EN\ LOW_ = LOAD\ EN\ HIGH_ = 0$, $SWEN = 1$, $T_J = +70^{\circ}C$ with an accuracy of $\pm 15^{\circ}C$. Specification compliance with supply and temperature variations is verified by guard-banding mean shifts of characterization data, unless otherwise noted. All temperature coefficients measured at $T_J = +50^{\circ}C$ to $+90^{\circ}C$, unless otherwise noted.) (Note 1)

PARAMETER	SYMBOL	CONDITIONS	MIN	TYP	MAX	UNITS
Rise/Fall Time, CMPH_ and CMPL_		20% to 80%, $V_{COMPHI_} = +1V$, $V_{COMPLO_} = 0V$, load = T-line, $50\Omega > 1ns$, 50Ω to GND		0.7		ns
PASSIVE LOAD (driver in high-impedance mode) (Note 13)						
DC CHARACTERISTICS $R_{DUT_} \geq 10M\Omega$, unless otherwise noted)						
LDV_ Voltage Range			-1.0		+5.2	V
Gain		Measured at 0V and +3V	0.99		1.01	V/V
Gain Temperature Coefficient		Measured at 0V and +3V		50		ppm/ $^{\circ}C$
Offset		$V_{LDV_} = +1.5V$			± 100	mV
Offset Temperature Coefficient				0.02		mV/ $^{\circ}C$
Power-Supply Rejection Ratio	PSRR	V_{DD} and V_{SS} independently varied over full range, $V_{LDV_} = +1.5V$	-18		+18	mV/V
		V_{DDSW} and V_{SSSW} independently varied over full range, $V_{LDV_} = +1.5V$	-10		+10	mV/V
Output Resistance Tolerance— High Value		$I_{DUT_} = \pm 2mA$, $V_{LDV_} = +1.5V$	710	750	790	Ω
Output Resistance Tolerance— Low Value		$I_{DUT_} = \pm 4mA$, $V_{LDV_} = +1.5V$	335	375	415	Ω
Output Resistance, Tolerance— High Value ($V_{DDSW} = +15V$)		$I_{DUT_} = \pm 2mA$, $V_{LDV_} = +1.5V$	735	800	865	Ω
Output Resistance, Tolerance— Low Value ($V_{DDSW} = +15V$)		$I_{DUT_} = \pm 4mA$, $V_{LDV_} = +1.5V$	360	425	490	Ω
Switch Resistance Variation		0 to +3V (relative to +1.5V)		± 10		%
		Full range (relative to +1.5V)		± 30		
Switch Resistance Variation ($V_{DDSW} = +15V$)		0 to +3V (relative to +1.5V)		± 10		%
		Full range (relative to +1.5V)		± 30		
Maximum Output Current		$V_{LDV_} = -1V$, $V_{DUT_} = +5V$	-4			mA
		$V_{LDV_} = +5V$, $V_{DUT_} = -1V$			+4	
Linearity Error, Full Range		Measured at -1V, +1.5V, and +5.2V (Notes 3, 14)			± 25	mV
AC CHARACTERISTICS						
Settling Time, LDV_ to Output		$V_{LDV_} = -1V$ to +5V step, $R_{DUT_} = 100k\Omega$ (Note 15)		0.5		μs
Output Transient Response		$V_{LDV_} = +1.5V$, $V_{DUT_} = -1V$ to +5V square wave at 1MHz, $R_{DUT_} = 50k\Omega$		20		ns

Quad, Ultra-Low-Power, 200Mbps ATE Drivers/Comparators

ELECTRICAL CHARACTERISTICS (continued)

($V_{DD} = +8V$, $V_{SS} = -5V$, $V_L = +3V$, $V_{DDSW} = +24.6V$, $V_{SSSW} = -1.25V$, $V_{COMPHI} = +1V$, $V_{COMPL0} = 0V$, $V_{LDV_} = 0V$, $LOAD\ EN\ LOW_ = LOAD\ EN\ HIGH_ = 0$, $SWEN = 1$, $T_J = +70^\circ C$ with an accuracy of $\pm 15^\circ C$. Specification compliance with supply and temperature variations is verified by guard-banding mean shifts of characterization data, unless otherwise noted. All temperature coefficients measured at $T_J = +50^\circ C$ to $+90^\circ C$, unless otherwise noted.) (Note 1)

PARAMETER	SYMBOL	CONDITIONS	MIN	TYP	MAX	UNITS
PMU SWITCHES (FORCE, SENSE, PMU_) (Note 13)						
Voltage Range			-1.0		+24	V
Voltage Range ($V_{DDSW} = +15V$)			-1.0		+10	V
Force Switch Resistance		$V_{FORCE} = +1.5V$, $I_{PMU_} = \pm 10mA$			40	Ω
Force Switch Resistance ($V_{DDSW} = +15V$)		$V_{FORCE} = +1.5V$, $I_{PMU_} = \pm 10mA$			47	Ω
Force Path Current		$V_{PMU_} = -1V$ to $+24V$, $V_{FORCE} = -1V$ to $+24V$			± 30	mA
Force Path Current ($V_{DDSW} = +15V$)		$V_{PMU_} = -1V$ to $+10V$, $V_{FORCE} = -1V$ to $+10V$			± 30	mA
Force Switch Resistance Variation		0V to +3V (relative to $V_{FORCE} = +1.5V$)			± 10	%
		Full range (Note 16)			± 40	
Force Switch Resistance Variation ($V_{DDSW} = +15V$)		0V to +3V (relative to $V_{FORCE} = +1.5V$)			± 15	%
		Full range (Note 16)			± 45	
Sense Switch Resistance		$V_{SENSE} = +1.5V$, $I_{PMU_} = \pm 0.4mA$	650	1000	1350	Ω
Sense Switch Resistance ($V_{DDSW} = +15V$)		$V_{SENSE} = +1.5V$, $I_{PMU_} = \pm 0.4mA$	850	1250	1800	Ω
Sense Switch Resistance Variation		Relative to +11.5V, full range			± 40	%
Sense Switch Resistance Variation ($V_{DDSW} = +15V$)		Relative to +4.5V, full range			± 40	%
PMU_ Capacitance		Force and sense switches open			6	pF
FORCE Capacitance		All channels of force and sense switches open			36	pF
SENSE Capacitance		All channels of force and sense switches open			8	pF
FORCE External Capacitance		Allowable external capacitance			2	nF
SENSE External Capacitance		Allowable external capacitance			1	nF
FORCE and SENSE Switching Speed		Connect, $PMU_ = +5V$, FORCE or SENSE 10M Ω 8pF			10	μs
		Disconnect, $PMU_ = +5V$, FORCE or SENSE 10M Ω 8pF			100	
PMU_ Leakage		$SWEN = 0$, or $PMU\ EN_ = 0$, $V_{FORCE_} = V_{SENSE_} = -1V$ to $+24V$		± 0.5	± 5	nA
PMU_ Leakage ($V_{DDSW} = +15V$)		$SWEN = 0$, or $PMU\ EN_ = 0$, $V_{FORCE_} = V_{SENSE_} = -1V$ to $+10V$		± 0.5	± 5	nA

MAX19005

Quad, Ultra-Low-Power, 200Mbps ATE Drivers/Comparators

ELECTRICAL CHARACTERISTICS (continued)

($V_{DD} = +8V$, $V_{SS} = -5V$, $V_L = +3V$, $V_{DDSW} = +24.6V$, $V_{SSSW} = -1.25V$, $V_{COMP HI} = +1V$, $V_{COMP LO} = 0V$, $V_{LDV} = 0V$, LOAD EN LOW_ = LOAD EN HIGH_ = 0, SWEN = 1, $T_J = +70^\circ C$ with an accuracy of $\pm 15^\circ C$. Specification compliance with supply and temperature variations is verified by guard-banding mean shifts of characterization data, unless otherwise noted. All temperature coefficients measured at $T_J = +50^\circ C$ to $+90^\circ C$, unless otherwise noted.) (Note 1)

PARAMETER	SYMBOL	CONDITIONS	MIN	TYP	MAX	UNITS
TOTAL FUNCTION						
DUT_						
Leakage, High-Impedance Mode		Passive load switches open, pin switch short, $V_{DUT_} = +5.2V$, $V_{CLV_} = V_{CHV_} = -1V$, $V_{DUT_} = -1V$, $V_{CLV_} = V_{CHV_} = +5.2V$, full range			2	μA
Low-Leakage Recovery Time		Confirmed simulation only (Note 17)		10		μs
Combined Capacitance		High-impedance mode, passive load switches open, pin switch short		10		pF
Load Resistance Range		(Note 18)		1		G Ω
Load Capacitance Range		(Note 18)		12		nF
Leakage, Pin Switch Off Mode		-1V to +24V, pin switch open		± 1	± 10	nA
Leakage, Pin Switch Off Mode ($V_{DDSW} = +15V$)		-1V to +10V, pin switch open		± 1	± 10	nA
Pin Switch Switching Speed		Connect or disconnect, $V_{DH_} = +5V$, $DUT_ = 10M\Omega \parallel 8pF$		10		μs
VOLTAGE REFERENCE INPUTS (DHV_, DLV_, CHV_, CLV_, LDV_, COMP HI, COMP LO)						
Input Bias Current					± 100	μA
SINGLE-ENDED CONTROL INPUTS (DATA_, RCV_)						
Input High Voltage			$V_{BBI} + 0.2$		3.2	V
Input Low Voltage			0	$V_{BBI} - 0.2$		V
Voltage Between Inputs and V_{BBI}			$V_{BBI} - 1.6$	$V_{BBI} + 1.6$		V
Input Offset Voltage				± 50		mV
Input Bias Current				± 100		μA
REFERENCE INPUT (V_{BBI})						
Input Voltage Range			0.2		3.0	V
Input Bias Current					± 100	μA
DIGITAL INPUTS (\overline{LD}, DIN, SCLK, \overline{CS})						
Input High Voltage		(Note 19)	$2/3 (V_L)$		V_L	V
Input Low Voltage		(Note 19)	-0.1		$1/3 (V_L)$	V
Input Bias Current					± 1	μA
SERIAL-DATA OUTPUT (DOUT)						
Output High Voltage		$I_{OH} = -1mA$	$V_L - 0.4$		$V_L + 0.1$	V
Output Low Voltage		$I_{OL} = +1mA$	$V_{DGND} - 0.1$		$V_{DGND} + 0.4$	V
Output Rise-and-Fall Time		$C_L = 10pF$		5.0		ns

MAX19005

Quad, Ultra-Low-Power, 200Mbps ATE Drivers/Comparators

ELECTRICAL CHARACTERISTICS (continued)

($V_{DD} = +8V$, $V_{SS} = -5V$, $V_L = +3V$, $V_{DDSW} = +24.6V$, $V_{SSSW} = -1.25V$, $V_{COMPHI} = +1V$, $V_{COMPL0} = 0V$, $V_{LDV_} = 0V$, $LOAD\ EN\ LOW_ = LOAD\ EN\ HIGH_ = 0$, $SWEN = 1$, $T_J = +70^\circ C$ with an accuracy of $\pm 15^\circ C$. Specification compliance with supply and temperature variations is verified by guard-banding mean shifts of characterization data, unless otherwise noted. All temperature coefficients measured at $T_J = +50^\circ C$ to $+90^\circ C$, unless otherwise noted.) (Note 1)

PARAMETER	SYMBOL	CONDITIONS	MIN	TYP	MAX	UNITS
SCLK Low to DOUT Delay		$C_L = 10pF$	4		45	ns
SERIAL-INTERFACE TIMING						
SCLK Frequency					20	MHz
SCLK Pulse-Width High	t_{CH}		20			ns
SCLK Pulse-Width Low	t_{CL}		20			ns
\overline{CS} Low to SCLK High Setup	t_{CSS0}		5			ns
SCLK High to \overline{CS} Low Hold	t_{CSH0}		0			ns
\overline{CS} High to SCLK High Setup	t_{CSS1}		20			ns
SCLK High to \overline{CS} High Hold	t_{CSH1}		20			ns
DIN to SCLK High Setup	t_{DS}		10			ns
DIN to SCLK High Hold	t_{DH}		10			ns
\overline{CS} High to \overline{LD} Low Hold	t_{CSHLD}		20			ns
\overline{CS} High Pulse Width	t_{CSWH}		20			ns
\overline{LD} Low Pulse Width	t_{LDW}		20			ns
V_L Rising to \overline{CS} Low		Power-on delay		2		μs
TEMPERATURE SENSOR						
Nominal Voltage		$T_J = +70^\circ C$, $R_L \geq 10M\Omega$		3.43		V
Temperature Coefficient				+10		mV/ $^\circ C$
Output Resistance				17		k Ω
POWER SUPPLIES						
Positive Supply Voltage	V_{DD}	(Note 20)	7.6	8	8.4	V
Negative Supply Voltage	V_{SS}	(Note 20)	-5.25	-5	-4.75	V
Logic Supply Voltage	V_L		2.3	3	3.6	V
Switch Positive Supply Voltage	V_{DDSW}	(Notes 20, 21)	24.1	24.6	25.1	V
Switch Positive Supply Voltage	V_{DDSW}	(Notes 20, 22)	14.5	15	15.5	V
Switch Negative Supply Voltage	V_{SSSW}	(Note 20)	-1.4	-1.25	-1.1	V
Positive Supply Current	I_{DD}	$f_{OUT} = 0MHz$		105	120	mA
Negative Supply Current	I_{SS}	$f_{OUT} = 0MHz$		105	120	mA
Logic Supply Current	I_L	$f_{OUT} = 0MHz$		1	4	mA
Switch Positive Supply Current	I_{DDSW}	$f_{OUT} = 0MHz$		2	6	mA
Switch Negative Supply Current	I_{SSSW}	$f_{OUT} = 0MHz$		1.5	5	mA
Static Power Dissipation		$f_{OUT} = 0MHz$		1.35	1.56	W
Operating Power Dissipation		$f_{OUT} = 100Mbps$ (Note 23)		1.45		W

Quad, Ultra-Low-Power, 200Mbps ATE Drivers/Comparators

ELECTRICAL CHARACTERISTICS (continued)

($V_{DD} = +8V$, $V_{SS} = -5V$, $V_L = +3V$, $V_{DDSW} = +24.6V$, $V_{SSSW} = -1.25V$, $V_{COMPHI} = +1V$, $V_{COMPL0} = 0V$, $V_{LDV_} = 0V$, $LOAD\ EN\ LOW_ = LOAD\ EN\ HIGH_ = 0$, $SWEN = 1$, $T_J = +70^{\circ}C$ with an accuracy of $\pm 15^{\circ}C$. Specification compliance with supply and temperature variations is verified by guard-banding mean shifts of characterization data, unless otherwise noted. All temperature coefficients measured at $T_J = +50^{\circ}C$ to $+90^{\circ}C$, unless otherwise noted.) (Note 1)

- Note 1:** All minimum and maximum DC, rise/fall time at +3V swing tests are 100% production tested. The propagation-delay data to output and propagation-delay comparator tests are guaranteed by design. All specifications are with DUT_ and PMU_ electrically isolated, unless otherwise noted.
- Note 2:** Resistance measurements are made using $\pm 2.5mA$ current changes in the loading instrument about the noted value. Absolute value of the difference in measured resistance over the specified range, tested separately for each current polarity. Test conditions are at $I_{DUT_} = \pm 1mA$, $\pm 12mA$, and $\pm 40mA$, respectively.
- Note 3:** Relative to a straight line through 0V and +3V.
- Note 4:** $V_{DHFV_} = +3V$, $V_{DLV_} = 0V$, unless otherwise specified. $DATA_ and RCV_ V_{HIGH} = +2V$, $V_{LOW} = 1V$, $V_{BBI} = +1.5V$.
- Note 5:** Current supplied for a minimum of 10ns. Verified to be greater than or equal to DC drive current by design and characterization.
- Note 6:** Undershoot is any reflection of the signal back towards its starting voltage after it has reached 90% of its swing. Preshoot is any aberration in the signal before it reaches 10% of its swing.
- Note 7:** At the minimum voltage swing, undershoot is less than 20%. DHV_ and DLV_ references are adjusted to result in the specified swing.
- Note 8:** At this pulse width, the output reaches at least 90% of its nominal (DC) amplitude. The pulse width is measured at DATA_.
- Note 9:** With the exception of offset and gain/CMRR tests, reference input values are calibrated for offset and gain.
- Note 10:** Measured by using a servo to locate comparator thresholds.
- Note 11:** Unless otherwise noted, all propagation delays are measured at 40MHz, $V_{DUT_} = 0$ to +1V, $V_{CHV_} = V_{CLV_} = +0.5V$, $t_R = t_F = 500ps$, $Z_S = 50\Omega$, driver in high-impedance mode. Comparator outputs are terminated with 50Ω to GND. Measured from $V_{DUT_}$ crossing calibrated CHV_/CLV_ threshold to midpoint of nominal comparator output swing.
- Note 12:** $V_{DUT_} = 200mV_{P-P}$. Propagation delay is compared to a reference time at +2V.
- Note 13:** Operating output voltage/current range of passive load and PMU force switch at +24.6V supply. See Figure 1.
- Note 14:** $LOAD\ EN\ LOW_ = LOAD\ EN\ HIGH_ = 1$.
- Note 15:** Waveform settles to within 5% of final value into $100k\Omega$ load.
- Note 16:** $I_{PMU_} = \pm 2mA$ at $V_{FORCE} = -1V$, +11.5V, and +24V. Percent variation relative to value calculated at $V_{FORCE} = +11.5V$.
- Note 17:** Time to return to the specified maximum leakage after a +3V, +4V/ns step at DUT_.
- Note 18:** Load at end of 2ns transmission line; for stability only, AC performance could be degraded.
- Note 19:** The driver meets all of its timing specifications at the specified digital input voltages.
- Note 20:** Specifications are simulated and characterized over the full power-supply range. Production tests are performed with power supplies at typical values.
- Note 21:** DUT_ (pin switch off), PMU_ maximum voltage is +24V.
- Note 22:** DUT_ (pin switch off), PMU_ maximum voltage is +10V.
- Note 23:** All channels driven at $3V_{P-P}$, load = 2ns, 50Ω transmission line terminated with 3pF.

MAX19005

Quad, Ultra-Low-Power, 200Mbps ATE Drivers/Comparators

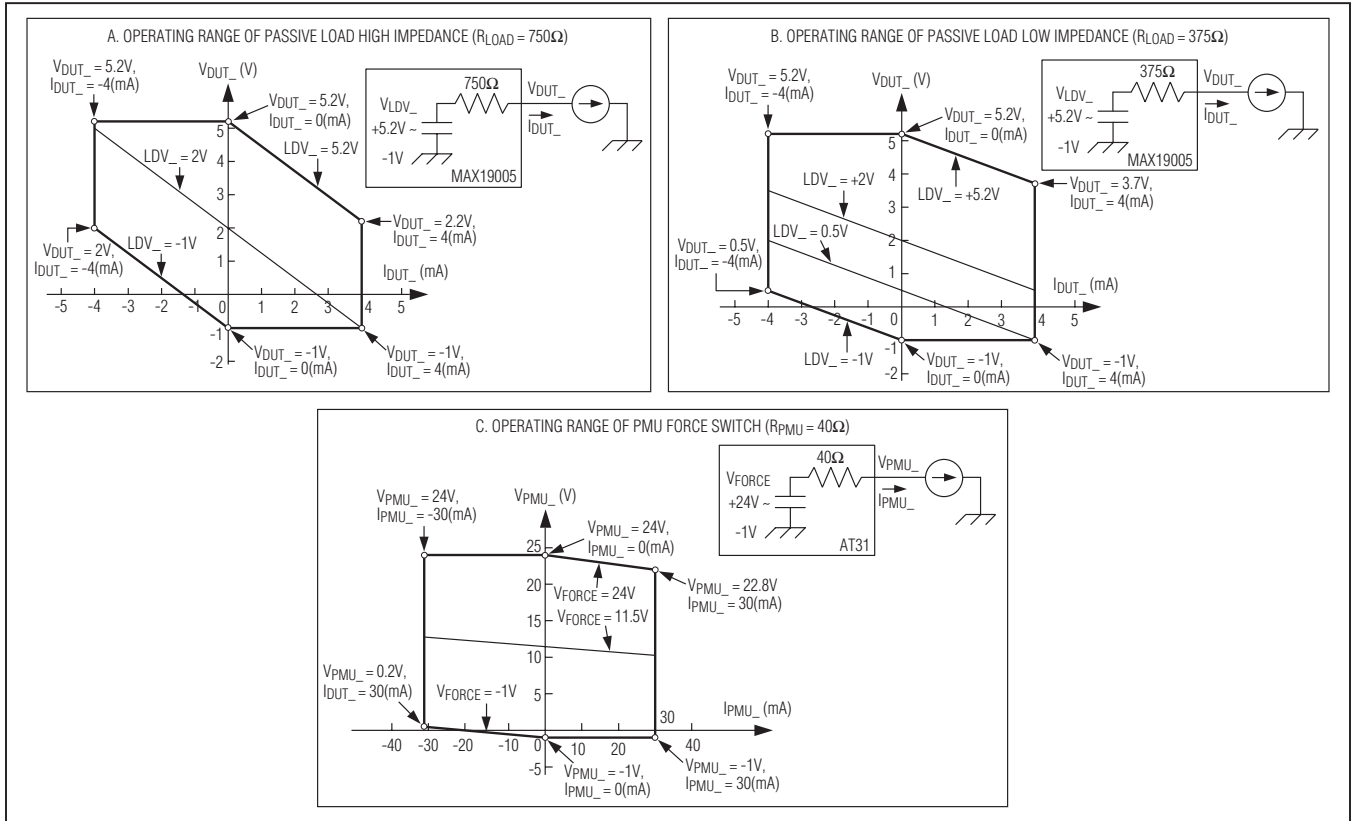

Figure 1. Operating Ranges

MAX19005

Quad, Ultra-Low-Power, 200Mbps ATE Drivers/Comparators

Typical Operating Characteristics

($V_{DD} = 8V$, $V_{SS} = -5V$, $V_L = 3V$, $V_{DDSW} = 24.6V$, $V_{SSSW} = 1.25V$, $V_{COMP HI} = 1V$, $V_{COMP LO} = 0V$, $V_{LDV_} = 0V$, LOAD EN LOW = LOAD EN HIGH = 0, SWEN = 1, temperature coefficients $T_J = +70^\circ C$ are measured at $T_J = +50^\circ C$ to $+90^\circ C$, unless otherwise noted.)

DRIVER SMALL-SIGNAL RESPONSE

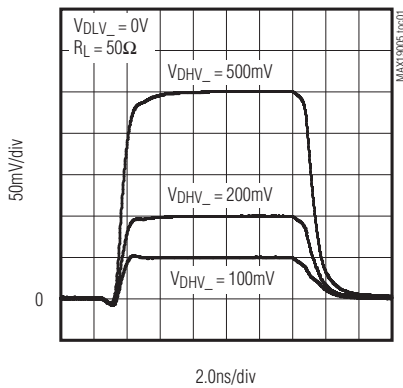

DRIVER LARGE-SIGNAL RESPONSE

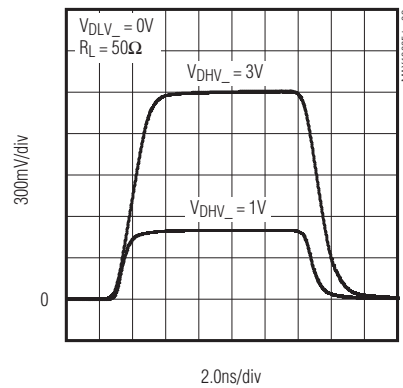

DRIVER LARGE-SIGNAL RESPONSE INTO 500Ω

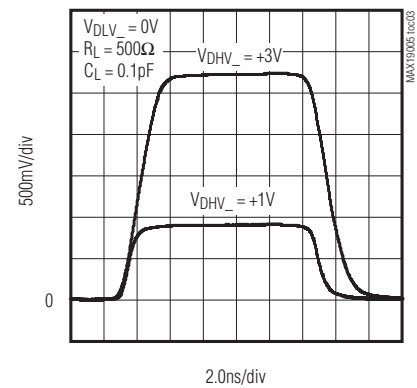

DRIVER 1Vp-p, 150Mbps SIGNAL RESPONSE

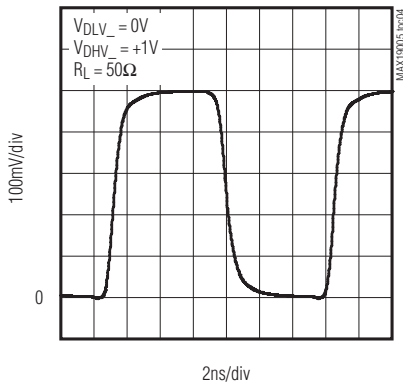

DRIVER 1Vp-p, 400Mbps SIGNAL RESPONSE

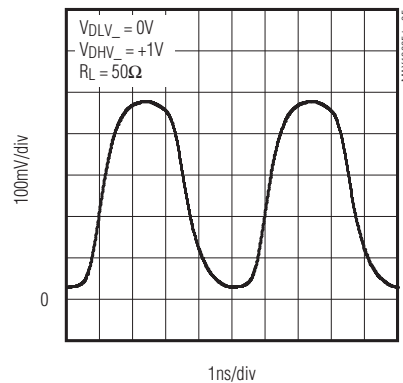

DRIVER 3Vp-p, 100Mbps SIGNAL RESPONSE

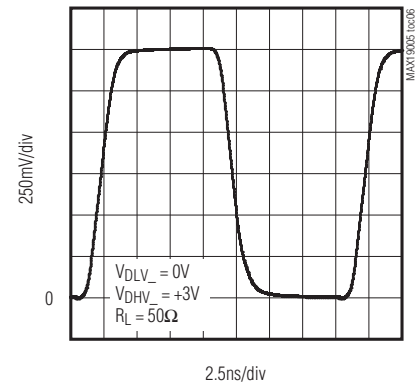

DRIVER 3Vp-p, 250Mbps SIGNAL RESPONSE

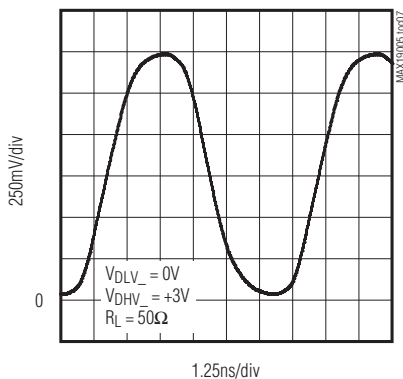

DRIVER DC CURRENT—LIMIT RESPONSE

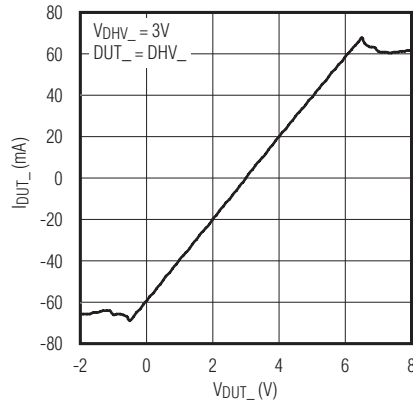

DRIVER 3V TRAILING-EDGE TIMING ERROR vs. PULSE WIDTH

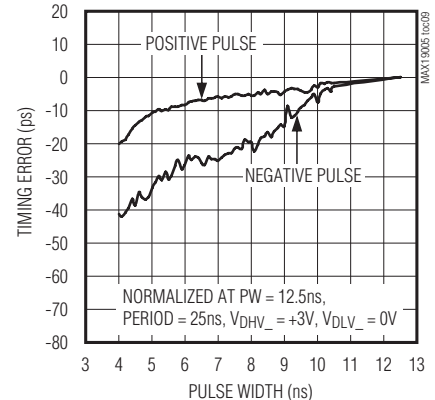

MAX19005

Quad, Ultra-Low-Power, 200Mbps ATE Drivers/Comparators

Typical Operating Characteristics (continued)

($V_{DD} = 8V$, $V_{SS} = -5V$, $V_L = 3V$, $V_{DDSW} = 24.6V$, $V_{SSSW} = 1.25V$, $V_{COMPHI} = 1V$, $V_{COMPLO} = 0V$, $V_{LDV} = 0V$, LOAD EN LOW = LOAD EN HIGH = 0, SWEN = 1, temperature coefficients $T_J = +70^\circ C$ are measured at $T_J = +50^\circ C$, to $+90^\circ C$ unless otherwise noted.)

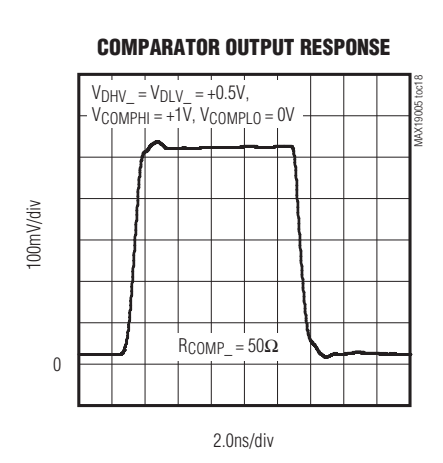
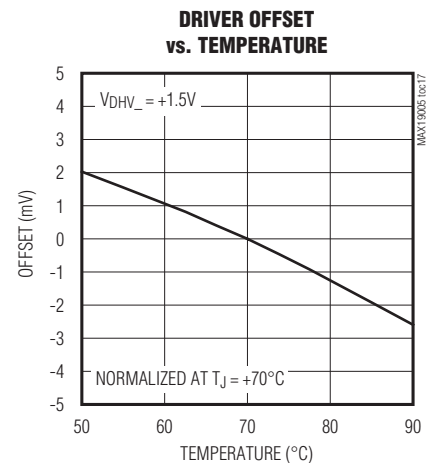
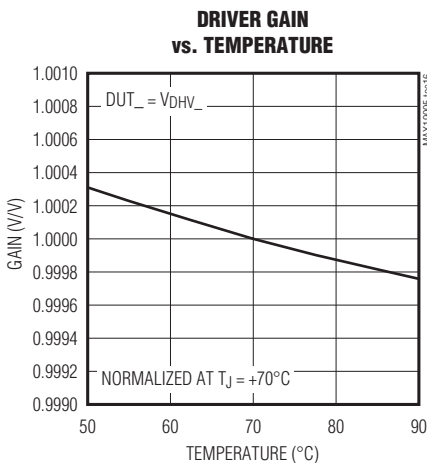
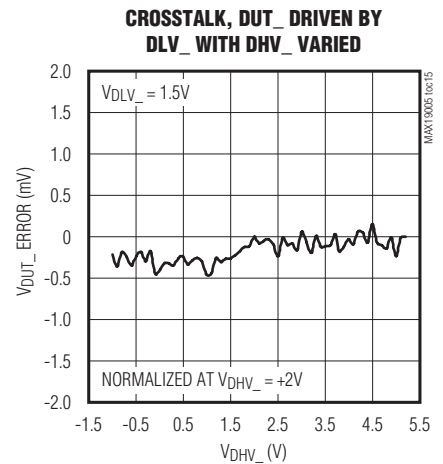
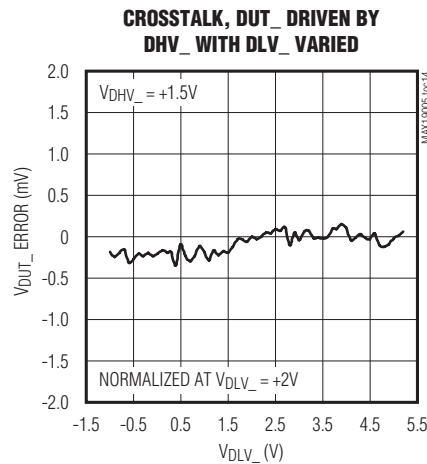
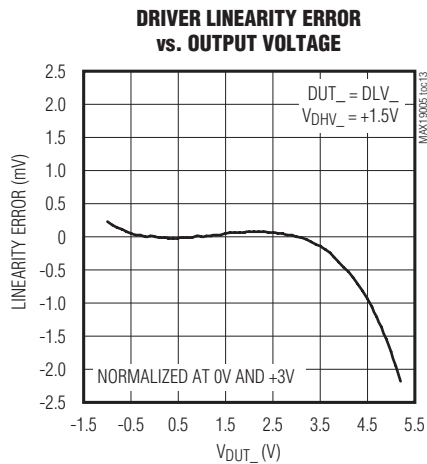
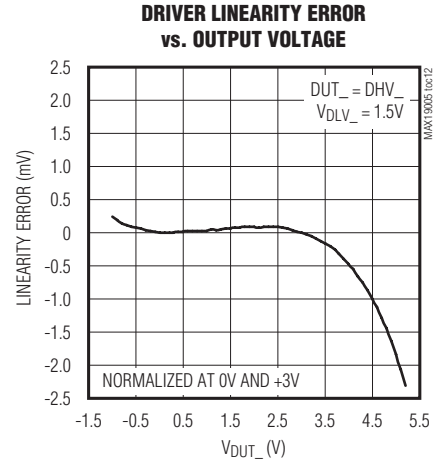
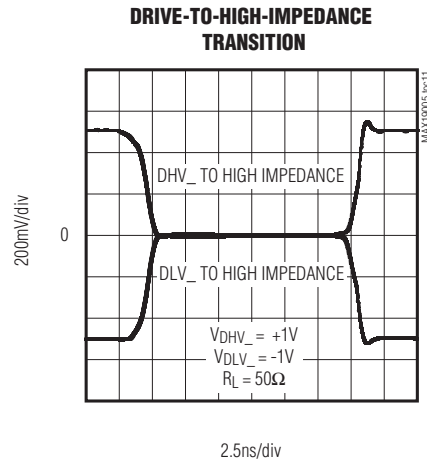
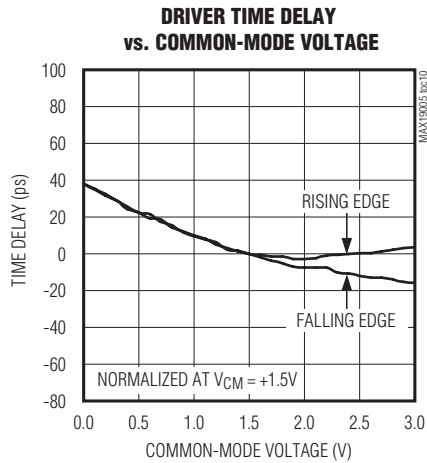

Quad, Ultra-Low-Power, 200Mbps ATE Drivers/Comparators

Typical Operating Characteristics (continued)

($V_{DD} = 8V$, $V_{SS} = -5V$, $V_L = 3V$, $V_{DDSW} = 24.6V$, $V_{SSSW} = 1.25V$, $V_{COMPHI} = 1V$, $V_{COMPL0} = 0V$, $V_{LDV_} = 0V$, $LOAD\ EN\ LOW = 0$, $LOAD\ EN\ HIGH = 0$, $SWEN = 1$, temperature coefficients $T_J = +70^\circ C$ are measured at $T_J = +50^\circ C$, to $+90^\circ C$ unless otherwise noted.)

COMPARATOR OFFSET vs. COMMON-MODE VOLTAGE

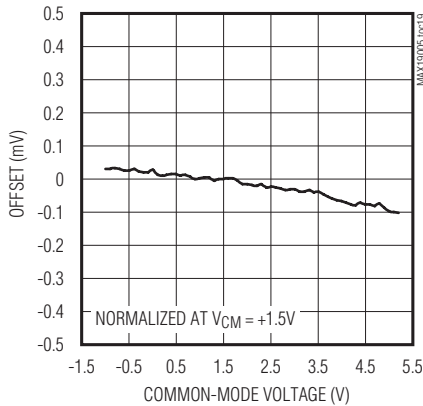

COMPARATOR OFFSET vs. TEMPERATURE

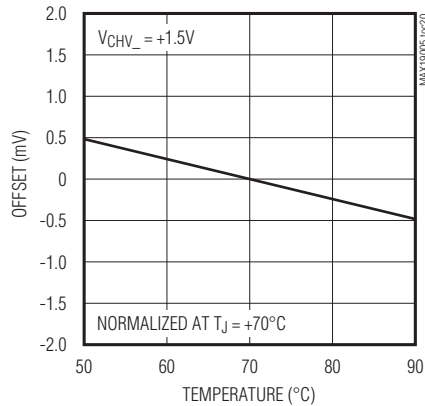

COMPARATOR WAVEFORM TRACKING

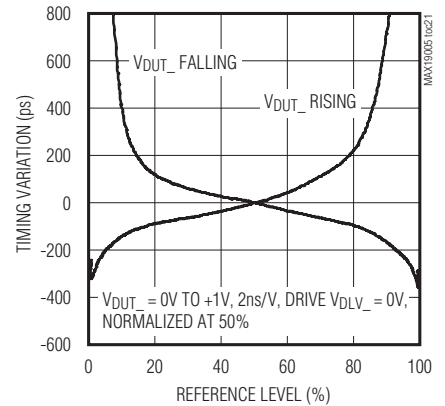

COMPARATOR RESPONSE vs. HIGH SLEW-RATE OVERDRIVE

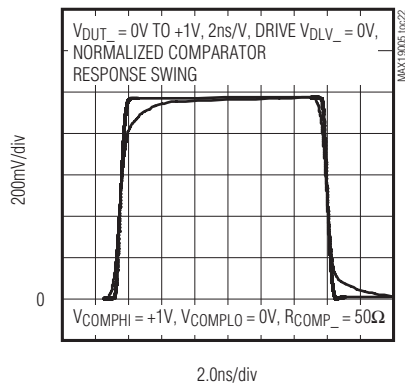

COMPARATOR TIMING VARIATION vs. PULSE WIDTH

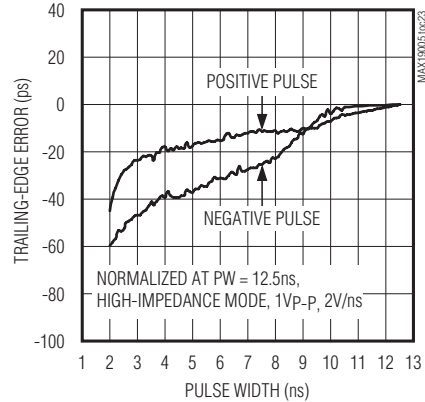

COMPARATOR TIMING VARIATION vs. INPUT SLEW RATE

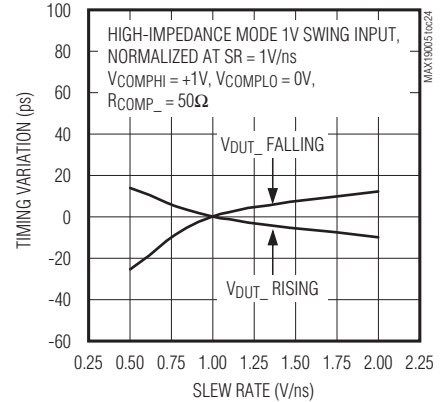

PASSIVE LOAD OFFSET vs. TEMPERATURE

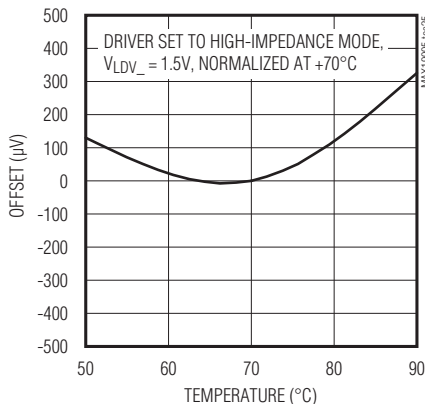

PASSIVE LOAD HIGH RESISTOR vs. VOLTAGE

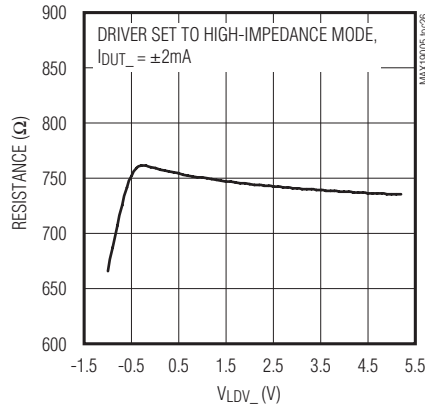

PASSIVE LOAD LOW RESISTOR vs. VOLTAGE

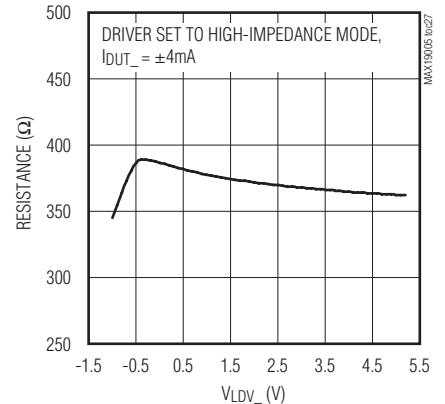

MAX19005

Quad, Ultra-Low-Power, 200Mbps ATE Drivers/Comparators

Typical Operating Characteristics (continued)

($V_{DD} = 8V$, $V_{SS} = -5V$, $V_L = 3V$, $V_{DDSW} = 24.6V$, $V_{SSSW} = 1.25V$, $V_{COMPHI} = 1V$, $V_{COMPLO} = 0V$, $V_{LDV_} = 0V$, LOAD EN LOW = LOAD EN HIGH = 0, SWEN = 1, temperature coefficients $T_J = +70^\circ C$ are measured at $T_J = +50^\circ C$, to $+90^\circ C$ unless otherwise noted.)

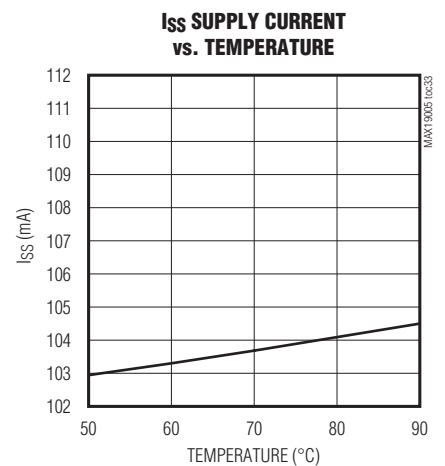
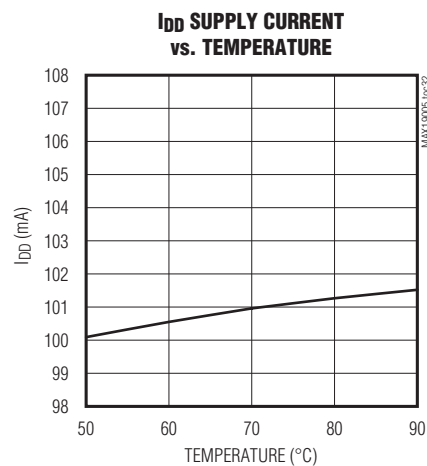
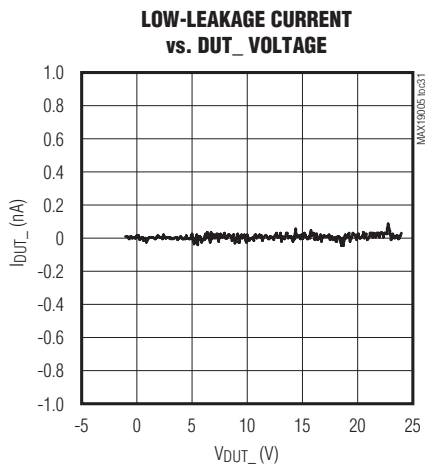
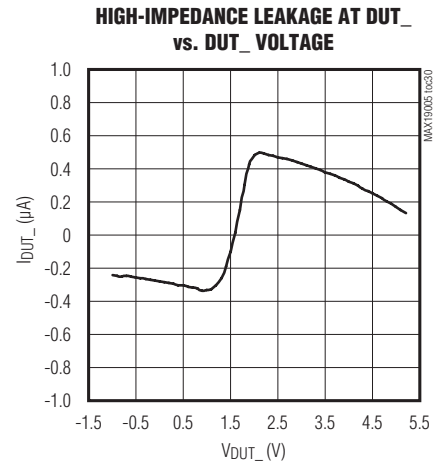
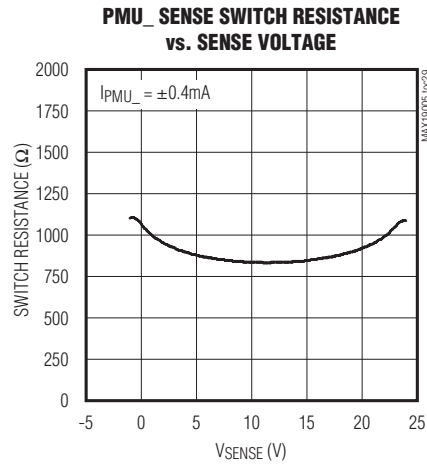
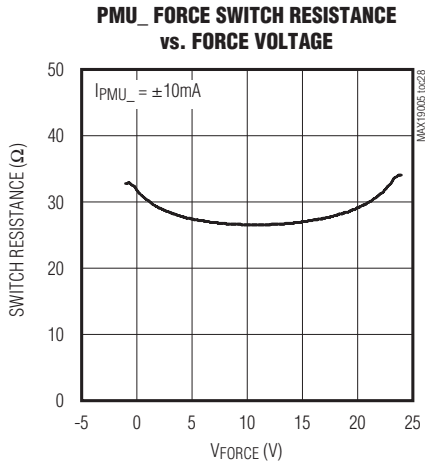

MAX19005

Quad, Ultra-Low-Power, 200Mbps ATE Drivers/Comparators

Pin Configuration

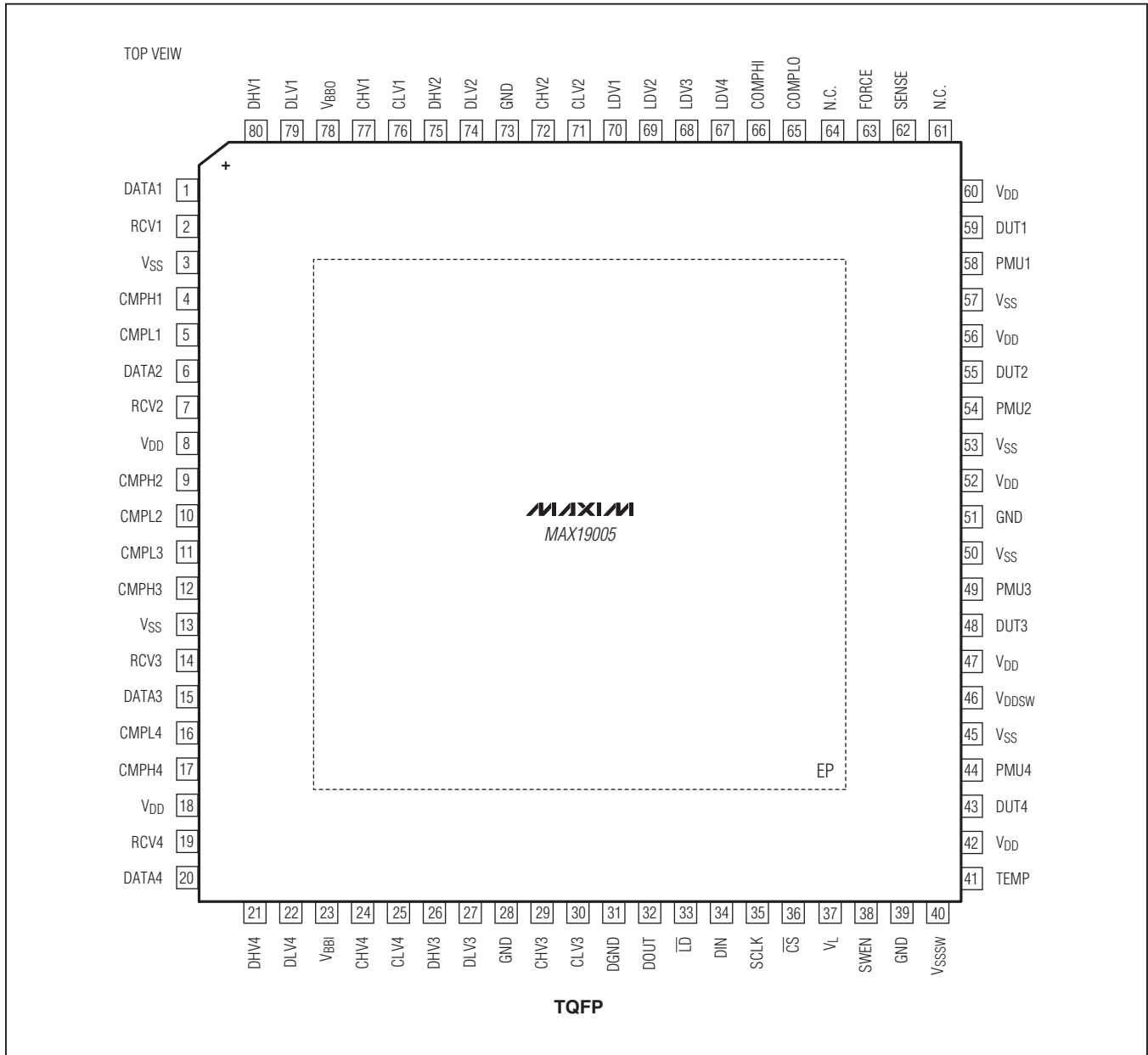

MAX19005

Quad, Ultra-Low-Power, 200Mbps ATE Drivers/Comparators

Pin Description

PIN	NAME	FUNCTION
1	DATA1	Channel 1 Multiplexer Control Input. Selects the driver 1 input from DHV1 or DLV1 in drive mode. See Table 1 and Figure 2.
2	RCV1	Channel 1 Multiplexer Control Input. Sets the channel 1 mode to drive or receive. See Table 1 and Figure 2.
3, 13, 45, 50, 53, 57	V _{SS}	Negative Power-Supply Input
4	CMPH1	Channel 1 High-Side Comparator Output
5	CMPL1	Channel 1 Low-Side Comparator Output
6	DATA2	Channel 2 Multiplexer Control Input. Selects the driver 2 input from DHV2 or DLV2 in drive mode. See Table 1 and Figure 2.
7	RCV2	Channel 2 Multiplexer Control Input. Sets the channel 2 mode to drive or receive. See Table 1 and Figure 2.
8, 18, 42, 47, 52, 56, 60	V _{DD}	Positive Power-Supply Input
9	CMPH2	Channel 2 High-Side Comparator Output
10	CMPL2	Channel 2 Low-Side Comparator Output
11	CMPL3	Channel 3 Low-Side Comparator Output
12	CMPH3	Channel 3 High-Side Comparator Output
14	RCV3	Channel 3 Multiplexer Control Input. Sets the channel 3 mode to drive or receive. See Table 1 and Figure 2.
15	DATA3	Channel 3 Multiplexer Control Input. Selects the driver 3 input from DHV3 or DLV3 in drive mode. See Table 1 and Figure 2.
16	CMPL4	Channel 4 Low-Side Comparator Output
17	CMPH4	Channel 4 High-Side Comparator Output
19	RCV4	Channel 4 Multiplexer Control Input. Sets the channel 4 mode to drive or receive. See Table 1 and Figure 2.
20	DATA4	Channel 4 Multiplexer Control Input. Selects driver 4 input from DHV4 or DLV4 in drive mode. See Table 1 and Figure 2.
21	DHV4	Channel 4 Driver High-Voltage Input
22	DLV4	Channel 4 Driver Low-Voltage Input
23	V _{BBI}	DATA_/RCV_ Threshold Voltage Input
24	CHV4	Channel 4 High-Side Comparator Threshold Voltage Input
25	CLV4	Channel 4 Low-Side Comparator Threshold Voltage Input
26	DHV3	Channel 3 Driver High-Voltage Input
27	DLV3	Channel 3 Driver Low-Voltage Input
28, 39, 51, 73	GND	Analog Ground
29	CHV3	Channel 3 High-Side Comparator Threshold Voltage Input
30	CLV3	Channel 3 Low-Side Comparator Threshold Voltage Input
31	DGND	Digital Ground Connection

MAX19005

Quad, Ultra-Low-Power, 200Mbps ATE Drivers/Comparators

Pin Description (continued)

PIN	NAME	FUNCTION
32	DOUT	Serial-Interface Data Output
33	$\overline{\text{LD}}$	Load Input. Latches data from the serial input register to the control register on rising edge. Transparent when low.
34	DIN	Serial-Interface Data Input
35	SCLK	Serial Clock
36	$\overline{\text{CS}}$	Chip Select
37	V_L	Logic Power-Supply Input
38	SWEN	PMU Switch and Pin Switch Enable Input
40	V_{SSSW}	PMU Switch and Pin Switch Negative Power-Supply Input
41	TEMP	Temperature Sensor Output
43	DUT4	Channel 4 Device-Under-Test Connection. Driver, comparator, and load I/O node for channel 4.
44	PMU4	Channel 4 Parametric Measurement Unit Connection. PMU switch I/O node for channel 4.
46	V_{DDSW}	Positive PMU Switch and Pin Switch Power-Supply Input
48	DUT3	Channel 3 Device-Under-Test Connection. Driver, comparator, and load I/O node for channel 3.
49	PMU3	Channel 3 Parametric Measurement Unit Connection. PMU switch I/O node for channel 3.
54	PMU2	Channel 2 Parametric Measurement Unit Connection. PMU switch I/O node for channel 2.
55	DUT2	Channel 2 Device-Under-Test Connection. Driver, comparator, and load I/O node for channel 2.
58	PMU1	Channel 1 Parametric Measurement Unit Connection. PMU switch I/O node for channel 1.
59	DUT1	Channel 1 Device-Under-Test Connection. Driver, comparator, and load I/O node for channel 1.
61, 64	N.C.	No Connection. Not internally connected.
62	SENSE	PMU Sense Connection
63	FORCE	PMU Force Connection
65	COMPLO	Comparator Output Low-Voltage Reference Input
66	COMPHI	Comparator Output High-Voltage Reference Input
67	LDV4	Channel 4 Load Voltage Input
68	LDV3	Channel 3 Load Voltage Input
69	LDV2	Channel 2 Load Voltage Input
70	LDV1	Channel 1 Load Voltage Input
71	CLV2	Channel 2 Low-Side Comparator Threshold Voltage Input
72	CHV2	Channel 2 High-Side Comparator Threshold Voltage Input
74	DLV2	Channel 2 Driver Low-Voltage Input
75	DHV2	Channel 2 Driver High-Voltage Input
76	CLV1	Channel 1 Low-Side Comparator Threshold Voltage Input
77	CHV1	Channel 1 High-Side Comparator Threshold Voltage Input
78	V_{BBO}	Comparator Output Threshold Voltage Output
79	DLV1	Channel 1 Driver Low-Voltage Input
80	DHV1	Channel 1 Driver High-Voltage Input
—	EP	Exposed Pad. Leave unconnected or connect to GND.

MAX19005

Quad, Ultra-Low-Power, 200Mbps ATE Drivers/Comparators

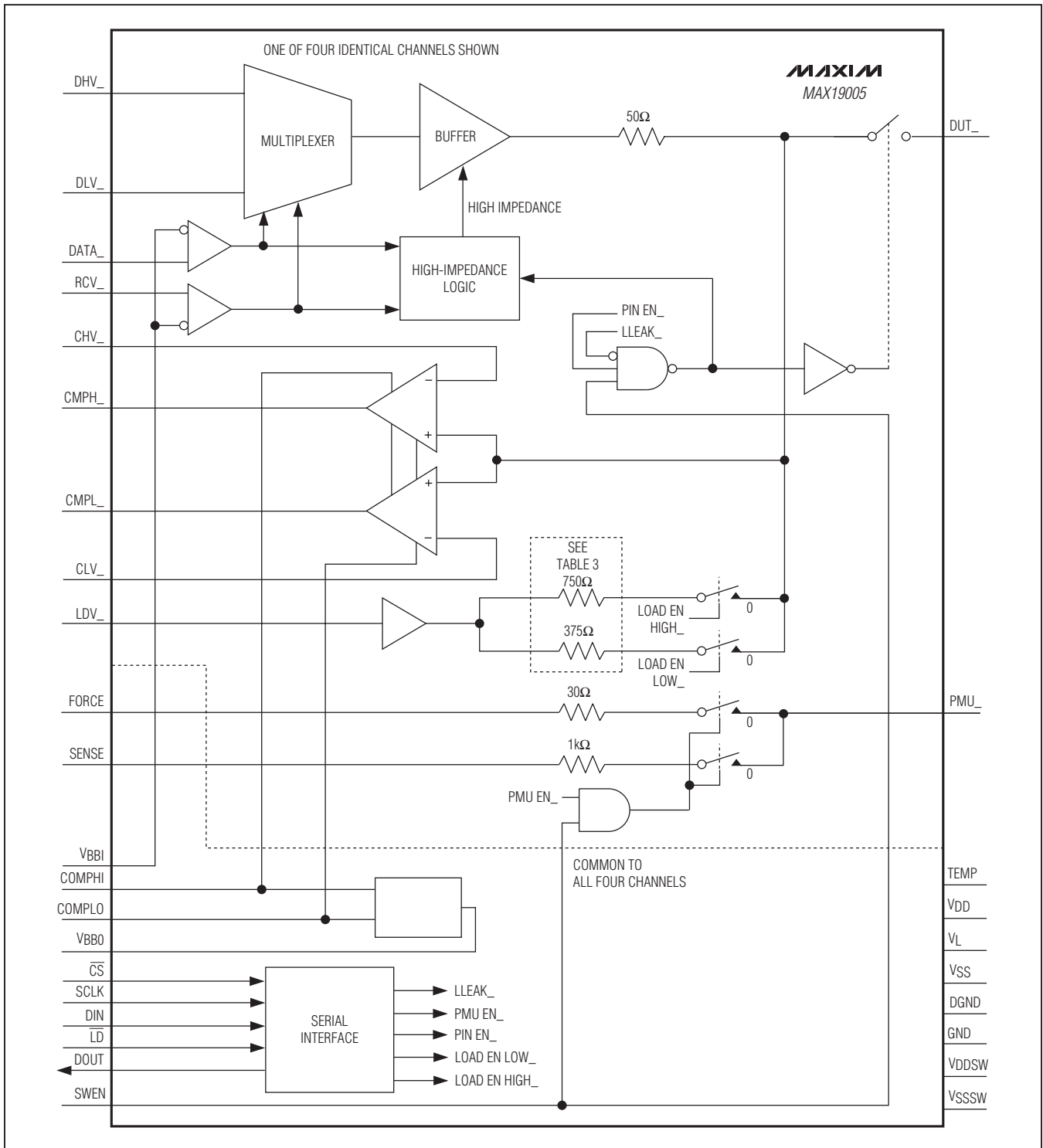

Figure 2. Block Diagram

MAX19005

Quad, Ultra-Low-Power, 200Mbps ATE Drivers/Comparators

Detailed Description

The MAX19005 is a four-channel, ultra-low-power, pin-electronics IC for automated test equipment that includes, for each channel, a two-level pin driver, a window comparator, a passive load, and a Kelvin instrument connection (Figure 2). All functions feature a -1V to +5.2V operating range and the drivers include a high-impedance mode. The comparators feature programmable output voltages, allowing optimization for different CMOS interface standards. The loads have selectable output resistance for optimizing DUT_ current loading. The Kelvin paths allow accurate connection of an instrument with $\pm 25\text{mA}$ source/sink capability. Additionally, the IC offers a low-leakage mode that reduces DUT_ leakage current to less than 20nA.

Each of the four channels feature single-ended CMOS-compatible inputs (DATA_ and RCV_) for control of the driver signal path (Figure 3). The IC mode operations

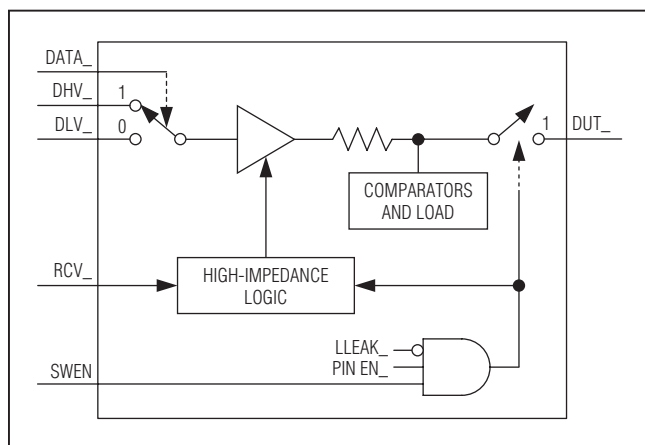

Figure 3. Multiplexer and Driver Channel

are programmed through a 3-wire, low-voltage CMOS-compatible serial interface.

The driver input is a high-speed multiplexer that selects one of two voltage inputs: DHV_ and DLV_. This switching is controlled by high-speed inputs DATA_ and RCV_. DATA_ and RCV_ are single-ended inputs with threshold levels (VBB1). Each channel's threshold levels are independently buffered to minimize crosstalk.

DUT_ can be toggled at high speed between the buffer output and high-impedance mode, or it can be placed into low-leakage mode (Figure 3, Table 1). High-speed input RCV_ and mode-control bit LLEAK_ control these modes. In high-impedance mode, the bias current at DUT_ is less than 2 μA over the -1V to +5.2V range, while the node maintains its ability to track high-speed signals. In low-leakage mode, the bias current at DUT_ is further reduced to less than 20nA, and signal tracking slows.

The nominal driver output resistance is 49.5 Ω .

Comparators

The IC provides two independent high-speed comparators for each channel. Each comparator has one input connected internally to DUT_ and the other input connected to either CHV_ or CLV_ (Figure 2). Comparator outputs are a logical result of the input conditions, as indicated in Table 2.

The comparator output voltages are easily interfaced to a wide variety of logic standards. Use buffered inputs COMPHI and COMPLO to set the high and low output voltages. For correct operation, COMPHI should be greater than or equal to COMPLO. The comparator 50 Ω output impedance provides source termination (Figure 4). VBB0 output voltage is provided, (COMPHI + COMPLO)/2.

Table 1. Component List

EXTERNAL PIN CONNECTIONS			INTERNAL REGISTER CONTROL BITS		DRIVER STATUS	PIN SWITCH STATUS
RCV_	DATA_	SWEN	PIN EN_	LLEAK_		
0	0	1	1	0	DUT_ = DLV_	Short
0	1	1	1	0	DUT_ = DHV_	Short
1	X	1	1	0	High impedance	Short
X	X	0	X	0	0V	Open
X	X	X	0	0	0V	Open
X	X	X	X	1	0V (low power)	Open

X = Don't care.

Quad, Ultra-Low-Power, 200Mbps ATE Drivers/Comparators

Table 2. Comparator Logic

CONDITION		CMPH_	CMPL_
DUT_ < CHV_	DUT_ < CLV_	0	0
DUT_ < CHV_	DUT_ > CLV_	0	1
DUT_ > CHV_	DUT_ < CLV_	1	0
DUT_ > CHV_	DUT_ > CLV_	1	1

Table 3. Passive Load Logic

INTERNAL CONTROL BITS		PASSIVE LOAD STATUS
LOAD EN HIGH_	LOAD EN LOW_	
0	0	Disconnect
0	1	375Ω load connect
1	0	750Ω load connect
1	1	750Ω 375Ω load connect

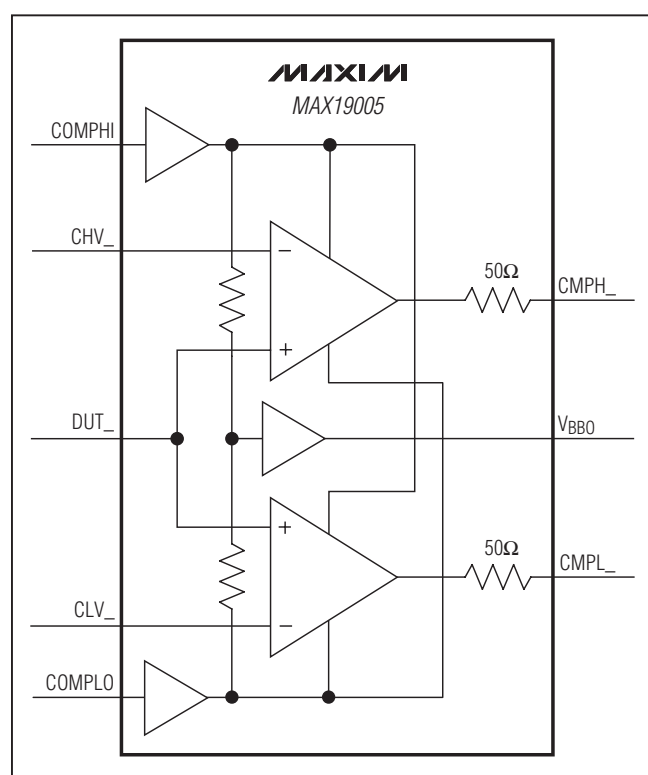

Figure 4. Complementary 50Ω Comparator Outputs

Passive Load

The IC channels each feature a passive load consisting of a buffered input voltage (LDV_) connected to DUT_ through two resistive paths (Figure 2). Each path connects to DUT_ individually by a switch controlled through the serial interface. Programming options include none (load disconnected), either, or both paths connected. The loads facilitate fast open/short testing in conjunction with the comparator, and pullup of open-drain DUT_ outputs. See Table 3.

Table 4. PMU Switch Logic

EXTERNAL CONNECTION	INTERNAL CONTROL BIT	PMU SWITCH STATUS
SWEN	PMU EN_	
0	X	Open
1	0	Open
1	1	Short

X = Don't care.

Parametric Switches

Each of the four IC channels provide force-and-sense paths for connection of a PMU or other DC resource to the device-under-test (Figure 2). Both force and sense switches are simultaneously controlled through the serial interface providing maximum application flexibility. PMU_ and DUT_ are provided on separate pins, allowing designs that do not require the parametric switch feature to avoid the added capacitance of PMU_. It also allows PMU_ to connect to DUT_, either directly or with an impedance-matching network. See Table 4.

Low-Leakage Mode (LLEAK_)

Asserting LLEAK_ through the serial port places the IC into a very-low-leakage state. See the Electrical Characteristics section. This mode is convenient for making IDDQ and PMU measurements without the need for an output disconnect relay. LLEAK_ control is independent for each channel.

When DUT_ is driven with a high-speed signal while LLEAK_ is asserted, the leakage current momentarily increases beyond the limits specified for normal operation. The low-leakage recovery specification in the Electrical Characteristics section indicates device behavior under this condition.

MAX19005

Quad, Ultra-Low-Power, 200Mbps ATE Drivers/Comparators

Temperature Monitor

Each device supplies a single temperature output signal (TEMP) that asserts a nominal +3.43V output voltage at a +70°C (343K) die temperature. The output voltage increases proportionately with temperature at a rate of 10mV/°C. The temperature sensor output impedance is 17kΩ (typ).

Serial Interface and Device Control

A CMOS-compatible serial interface controls the IC modes (Figure 5). Control data flow into a 12-bit shift register (LSB first) and are latched when CS is taken high. Data from the shift register are then loaded to the per-channel control latches, as determined by bits D[8:11] (Figure 5 and Table 5). The latches contain the five mode bits for each channel of the device. The mode bits, in conjunction with external inputs DATA_ and

RCV_, manage the features of each channel. Transfer data asynchronously from the input registers to the channel registers by forcing LD low. With LD always low, data transfer on the rising edge of CS.

Heat Removal

With adequate airflow, no external heat sinking is needed under most operating conditions. If excess heat must be dissipated through the exposed pad, solder it to circuit-board copper. The exposed pad must be either left unconnected, isolated, or connected to GND.

Power Minimization

To minimize power consumption, activate only the needed channels. Each channel placed in low-leakage mode saves approximately 240mW.

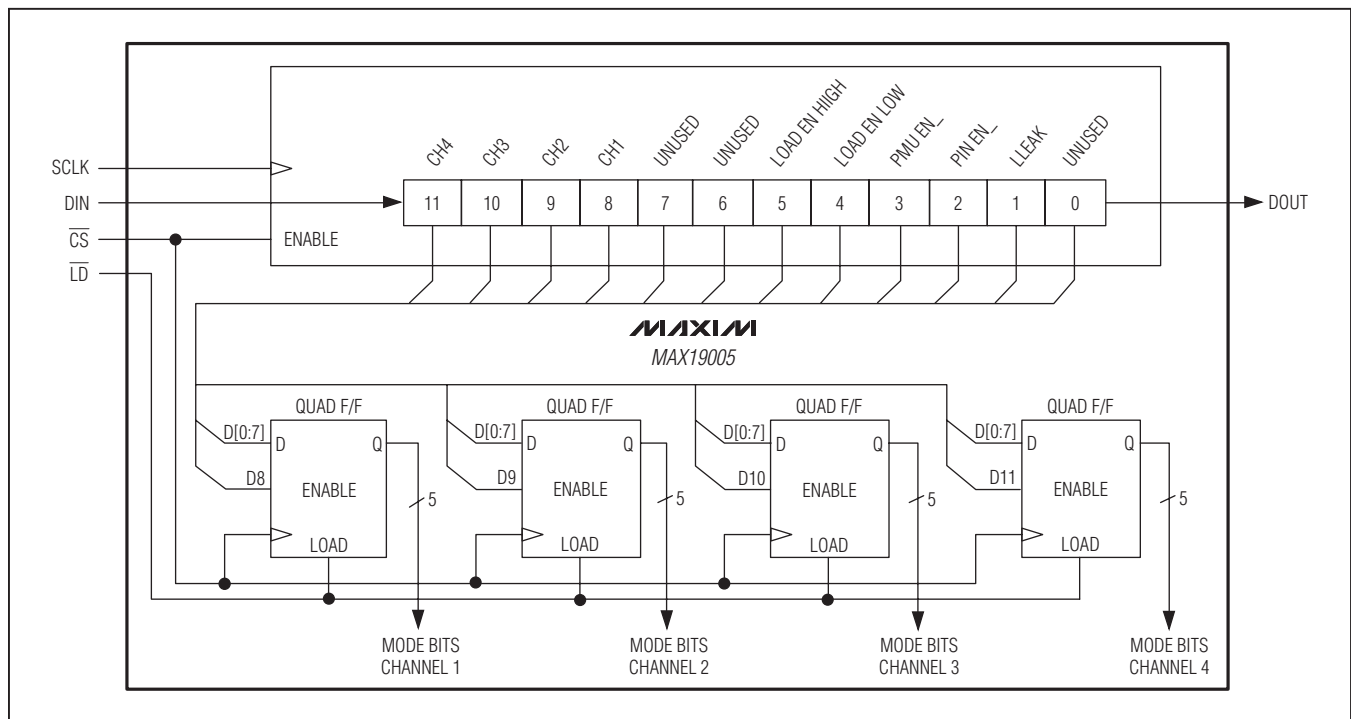

Figure 5. Serial Interface

Quad, Ultra-Low-Power, 200Mbps ATE Drivers/Comparators

Table 5. Control Register Bits

BIT	NAME	FUNCTION	BIT STATE		POWER-UP STATE
			0	1	
D0	—	Unused	X	X	0
D1	LLEAK	Assert low-leakage mode	Active	Low leakage	0
D2	PIN EN	Enable pin switch	Disabled	Enabled	0
D3	PMU EN	Enable PMU switch	Disabled	Enabled	0
D4	LOAD EN LOW	Enable low load resistor	Disabled	Enabled	0
D5	LOAD EN HIGH	Enable high load resistor	Disabled	Enabled	0
D6	—	Unused	X	X	0
D7	—	Unused	X	X	0
D8	CH1	Update channel 1 control register	Disabled	Enabled	1
D9	CH2	Update channel 2 control register	Disabled	Enabled	1
D10	CH3	Update channel 3 control register	Disabled	Enabled	1
D11	CH4	Update channel 4 control register	Disabled	Enabled	1

X = Don't care.

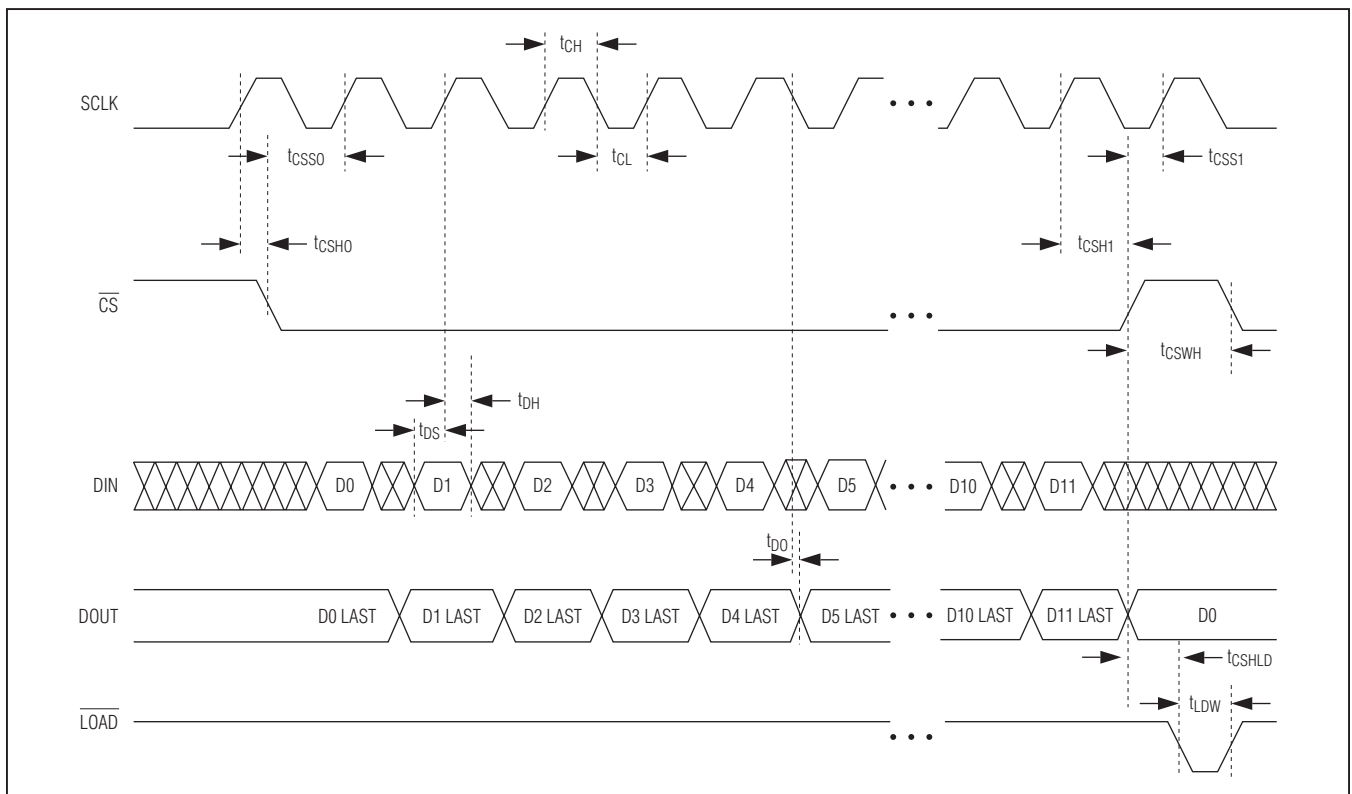

Figure 6. Serial-Interface Timing

MAX19005

Quad, Ultra-Low-Power, 200Mbps ATE Drivers/Comparators

Ordering Information

PART	TEMP RANGE	PIN-PACKAGE	HEAT EXTRACTION
MAX19005CCS+	0°C to +70°C	80 TQFP-EP*	Bottom

+Denotes a lead(Pb)-free/RoHS-compliant package.

*EP = Exposed pad.

Chip Information

PROCESS: BiCMOS

Package Information

For the latest package outline information and land patterns (footprints), go to www.maxim-ic.com/packages. Note that a "+", "#", or "-" in the package code indicates RoHS status only. Package drawings may show a different suffix character, but the drawing pertains to the package regardless of RoHS status.

PACKAGE TYPE	PACKAGE CODE	OUTLINE NO.	LAND PATTERN NO.
80 TQFP-EP	C80E+4	21-0115	90-0152

MAX19005

Quad, Ultra-Low-Power, 200Mbps ATE Drivers/Comparators

Revision History

REVISION NUMBER	REVISION DATE	DESCRIPTION	PAGES CHANGED
0	12/11	Initial release	—

Maxim cannot assume responsibility for use of any circuitry other than circuitry entirely embodied in a Maxim product. No circuit patent licenses are implied. Maxim reserves the right to change the circuitry and specifications without notice at any time. The parametric values (min and max limits) shown in the Electrical Characteristics table are guaranteed. Other parametric values quoted in this data sheet are provided for guidance.

Maxim Integrated Products, 120 San Gabriel Drive, Sunnyvale, CA 94086 408-737-7600 _____ **25**