

## FEATURES

**Operation: 2.3 GHz to 4.0 GHz**  
**Gain of 14.0 dB at 2.6 GHz**  
**OIP3 of 41.0 dBm at 2.6 GHz**  
**P1dB of 25.7 dBm at 2.6 GHz**  
**Noise figure: 4.0 dB at 2.6 GHz**  
**Power supply voltage: 3.3 V to 5 V**  
**Power supply current: 37 mA to 90 mA**  
**Dynamically adjustable bias**  
**No bias resistor required**  
**Thermally efficient, MSL-1 rated SOT-89 package**  
**Operating temperature range: -40°C to +105°C**  
**ESD rating of ±2 kV (Class 3A)**

## APPLICATIONS

**Wireless infrastructure**  
**Automated test equipment**  
**ISM/AMR applications**

## GENERAL DESCRIPTION

The **ADL5321** incorporates a dynamically adjustable biasing circuit that allows for the customization of OIP3 and P1dB performance from 3.3 V to 5 V without the need for an external bias resistor. This feature gives the designer the ability to tailor driver amplifier performance to the specific needs of the design. This feature also creates the opportunity for dynamic biasing of the driver amplifier, where a variable supply is used to allow for full 5 V biasing under large signal conditions and then can reduce the supply voltage when signal levels are smaller and lower power consumption is desirable. This scalability reduces the need to evaluate and inventory multiple driver amplifiers for different output power requirements from 22 dBm to 26 dBm output power levels.

The **ADL5321** is also rated to operate across the wide temperature range of -40°C to +105°C for reliable performance in designs that experience higher temperatures, such as power amplifiers. The ¼ watt driver amplifier covers the 2.3 GHz to 4.0 GHz wide frequency range and only requires a few external components to be tuned to a specific band within that wide range. This high performance, broadband RF driver amplifier is well suited for a variety of wired and wireless applications including cellular infrastructure, ISM band power amplifiers, defense equipment, and instrumentation equipment. A fully populated evaluation board is available.

## FUNCTIONAL BLOCK DIAGRAM

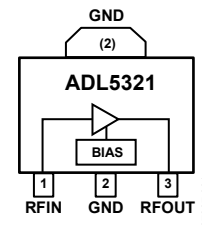

Figure 1.

The **ADL5321** also delivers excellent adjacent channel leakage ratio (ACLR) vs.  $P_{OUT}$ . For output powers up to 10 dBm rms, the **ADL5321** adds very little distortion to the output spectrum. At 2.6 GHz, the ACLR is -59 dB and a relative constellation error of -46.6 dB (<0.5% EVM) at an output power of 10 dBm rms.

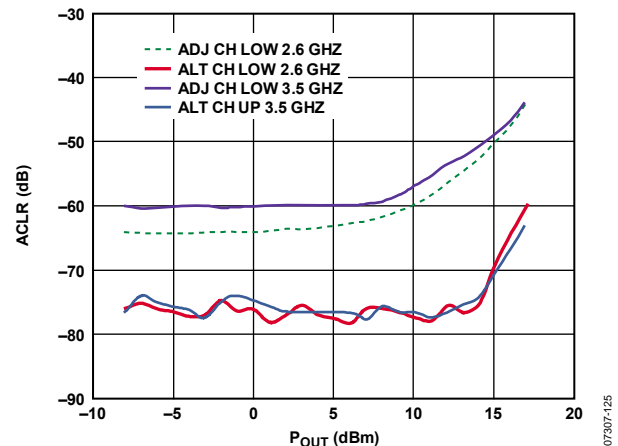

Figure 2. WiMAX 64 QAM, 10 MHz Bandwidth, Single Carrier

Rev. D

[Document Feedback](#)

Information furnished by Analog Devices is believed to be accurate and reliable. However, no responsibility is assumed by Analog Devices for its use, nor for any infringements of patents or other rights of third parties that may result from its use. Specifications subject to change without notice. No license is granted by implication or otherwise under any patent or patent rights of Analog Devices. Trademarks and registered trademarks are the property of their respective owners.

# ADL5321\* PRODUCT PAGE QUICK LINKS

Last Content Update: 02/23/2017

---

## COMPARABLE PARTS

View a parametric search of comparable parts.

## EVALUATION KITS

- ADL5321 Evaluation Board

## DOCUMENTATION

### Application Notes

- AN-1363: Meeting Biasing Requirements of Externally Biased RF/Microwave Amplifiers with Active Bias Controllers
- Broadband Biasing of Amplifiers General Application Note
- MMIC Amplifier Biasing Procedure Application Note
- Thermal Management for Surface Mount Components General Application Note

### Data Sheet

- ADL5321: 2.3 GHz to 4.0 GHz ¼ Watt RF Driver Amplifier Data Sheet

## TOOLS AND SIMULATIONS

- ADI RF Amplifier Library for Agilent ADS
- ADIsimPLL™
- ADIsimRF
- ADL5321 S Parameters

## REFERENCE MATERIALS

### Press

- New Version of Simulation Tool Significantly Eases Development of RF Systems

### Product Selection Guide

- RF Source Booklet

## DESIGN RESOURCES

- ADL5321 Material Declaration
- PCN-PDN Information
- Quality And Reliability
- Symbols and Footprints

## DISCUSSIONS

View all ADL5321 EngineerZone Discussions.

## SAMPLE AND BUY

Visit the product page to see pricing options.

## TECHNICAL SUPPORT

Submit a technical question or find your regional support number.

## DOCUMENT FEEDBACK

Submit feedback for this data sheet.

---

## TABLE OF CONTENTS

Features .....	1	Typical Performance Characteristics .....	7
Applications .....	1	High Temperature and 3.3 V Operation .....	10
Functional Block Diagram .....	1	Basic Layout Connections .....	11
General Description .....	1	Soldering Information and Recommended PCB Land Pattern .....	11
Revision History .....	2	Matching Procedure .....	12
Specifications .....	3	WiMAX Operation .....	13
Typical Scattering Parameters .....	4	Evaluation Board .....	14
Absolute Maximum Ratings .....	5	Outline Dimensions .....	16
Thermal Resistance .....	5	Ordering Guide .....	16
ESD Caution .....	5		
Pin Configuration and Function Descriptions .....	6		

## REVISION HISTORY

### 3/14—Rev. C to Rev. D

Changes to Figure 29 .....	11
Updated Outline Dimensions .....	16

### 7/12—Rev. B to Rev. C

Change to Title .....	1
Changes to Table 1 .....	3
Replaced Table 2 .....	4
Changes to Table 3 and Table 4 .....	5
Added Figure 20; Renumbered Sequentially .....	9
Moved High Temperature and 3.3 V Operation Section and added Figure 30 to Figure 32 .....	10
Changes to Soldering Information and Recommended PCB Land Pattern Section and changes to Figure 22 .....	11

### 6/10—Rev. A to Rev. B

Changes to General Description Section .....	1
Changes to Operating Temperature Range, Table 3 .....	4
Added High Temperature Operation Section, Figure 27, Figure 28, and Figure 29 .....	13
Changes to Ordering Guide .....	16

### 2/09—Rev. 0 to Rev. A

Updated Outline Dimensions .....	15
Changes to Ordering Guide .....	15

### 5/08—Revision 0: Initial Version

## SPECIFICATIONS

T<sub>A</sub> = 25°C, unless otherwise noted.

Table 1.

Parameter	Conditions	3.3 V			5 V			Unit
		Min	Typ	Max	Min	Typ	Max	
OVERALL FUNCTION								
Frequency Range		2.3		4.0	2.3		4.0	GHz
FREQUENCY = 2.6 GHz								
Gain <sup>1</sup>			12.6		13.2	14.0	14.6	dB
vs. Frequency	±100 MHz		±0.3			±0.4		dB
vs. Temperature	−40°C ≤ T <sub>A</sub> ≤ +85°C		±0.6			±0.7		dB
vs. Supply	3.2 V to 3.4 V, 4.75 V to 5.25 V		±0.16			±0.07		dB
Output 1 dB Compression Point, P1dB			22.0			25.7		dBm
Output Third-Order Intercept, OIP3	Δf = 1 MHz, P <sub>OUT</sub> = 5 dBm per tone		31			41		dBm
Noise Figure			3.5			4.0		dB
FREQUENCY = 3.5 GHz								
Gain <sup>1</sup>			10.4		11.1	12.0	12.9	dB
vs. Frequency	±100 MHz		±0.17			±0.05		dB
vs. Temperature	−40°C ≤ T <sub>A</sub> ≤ +85°C		±0.7			±0.8		dB
vs. Supply	3.2 V to 3.4 V, 4.75 V to 5.25 V		±0.2			±0.07		dB
Output 1 dB Compression Point, P1dB			24.7			25.7		dBm
Output Third-Order Intercept, OIP3	Δf = 1 MHz, P <sub>OUT</sub> = 5 dBm per tone		27			38		dBm
Noise Figure			4.3			4.9		dB
POWER INTERFACE	Pin RFOUT							
Supply Voltage			3.3		4.5	5	5.5	V
Supply Current			37			90	100	mA
vs. Temperature	−40°C ≤ T <sub>A</sub> ≤ +85°C		±4.0			±6.0		mA
Power Dissipation	VCC = 3.3 V, VCC = 5 V		122			520		mW

<sup>1</sup> Guaranteed maximum and minimum specified limits on this parameter are based on six sigma calculations.

**TYPICAL SCATTERING PARAMETERS**

VCC = 5 V and T<sub>A</sub> = 25°C; the effects of the test fixture have been de-embedded up to the pins of the device.

Table 2.

Frequency (MHz)	S11		S21		S12		S22	
	Magnitude (dB)	Angle (°)	Magnitude (dB)	Angle (°)	Magnitude (dB)	Angle (°)	Magnitude (dB)	Angle (°)
2400	-4.54	129.60	11.90	21.92	-26.72	-33.83	-8.18	-166.39
2450	-4.65	126.65	11.89	18.30	-26.63	-36.64	-8.27	-169.02
2500	-4.79	123.62	11.88	14.57	-26.55	-39.62	-8.37	-171.83
2550	-4.92	120.44	11.87	10.68	-26.48	-42.70	-8.45	-175.32
2600	-5.04	117.31	11.85	6.80	-26.42	-45.95	-8.44	-179.11
2650	-5.17	114.43	11.83	2.90	-26.37	-49.25	-8.39	177.31
2700	-5.33	111.78	11.80	-1.06	-26.34	-52.65	-8.33	173.43
2750	-5.50	109.21	11.77	-5.17	-26.31	-56.16	-8.15	169.22
2800	-5.70	106.84	11.74	-9.36	-26.30	-59.84	-7.90	165.46
2850	-5.94	104.85	11.71	-13.64	-26.30	-63.64	-7.63	161.87
2900	-6.25	103.23	11.66	-18.05	-26.31	-67.63	-7.31	158.01
2950	-6.61	101.91	11.62	-22.58	-26.34	-71.77	-6.88	154.58
3000	-7.03	101.06	11.56	-27.18	-26.37	-76.13	-6.44	151.64
3050	-7.53	100.92	11.50	-31.98	-26.44	-80.76	-6.00	148.53
3100	-8.12	101.82	11.40	-36.95	-26.55	-85.61	-5.53	145.65
3150	-8.78	104.04	11.29	-42.09	-26.68	-90.69	-5.03	143.14
3200	-9.47	107.91	11.15	-47.34	-26.85	-95.96	-4.56	140.74
3250	-10.07	113.72	10.97	-52.74	-27.06	-101.50	-4.08	138.36
3300	-10.45	121.55	10.76	-58.29	-27.32	-107.30	-3.61	136.16
3350	-10.45	130.87	10.49	-63.95	-27.65	-113.32	-3.19	133.97
3400	-10.02	140.04	10.17	-69.56	-28.05	-119.45	-2.80	131.77
3450	-9.25	147.61	9.80	-75.16	-28.49	-125.70	-2.43	129.85
3500	-8.28	153.06	9.39	-80.70	-29.00	-132.04	-2.13	128.08
3550	-7.27	156.76	8.92	-86.04	-29.58	-138.45	-1.89	126.22
3600	-6.34	159.01	8.39	-91.20	-30.20	-144.79	-1.66	124.51
3650	-5.51	160.11	7.83	-96.07	-30.88	-151.12	-1.48	123.23
3700	-4.78	160.43	7.26	-100.64	-31.57	-157.36	-1.37	122.16
3750	-4.14	160.36	6.66	-104.97	-32.29	-163.69	-1.27	121.07
3800	-3.60	160.07	6.04	-108.96	-33.02	-170.01	-1.19	120.25
3850	-3.16	159.62	5.43	-112.61	-33.74	-176.34	-1.14	119.79
3900	-2.78	158.95	4.82	-116.07	-34.44	177.21	-1.12	119.31
3950	-2.45	158.24	4.20	-119.27	-35.12	170.60	-1.10	118.94
4000	-2.17	157.64	3.60	-122.18	-35.74	163.89	-1.09	118.86

## ABSOLUTE MAXIMUM RATINGS

Table 3.

Parameter	Rating
Supply Voltage, VCC	6.5 V
Input Power, 50 $\Omega$ Impedance	20 dBm
Internal Power Dissipation, Paddle Soldered	683 mW
$\theta_{JC}$ , Junction to Paddle	28.5°C/W
Maximum Junction Temperature	150°C
Operating Temperature Range	-40°C to +105°C
Storage Temperature Range	-65°C to +150°C

Stresses above those listed under Absolute Maximum Ratings may cause permanent damage to the device. This is a stress rating only; functional operation of the device at these or any other conditions above those indicated in the operational section of this specification is not implied. Exposure to absolute maximum rating conditions for extended periods may affect device reliability.

## THERMAL RESISTANCE

Table 4 lists the junction-to-air thermal resistance ( $\theta_{JA}$ ) and the junction-to-paddle thermal resistance ( $\theta_{JC}$ ) for the [ADL5321](#).

Table 4. Thermal Resistance

Package Type	$\theta_{JA}$ <sup>1</sup>	$\theta_{JC}$ <sup>2</sup>	Unit
3-Lead SOT-89	35	11	°C/W

<sup>1</sup> Measured on Analog Devices evaluation board. For more information about board layout, see the Soldering Information and Recommended PCB Land Pattern section.

<sup>2</sup> Based on simulation with JEDEC standard JESD51.

## ESD CAUTION



**ESD (electrostatic discharge) sensitive device.** Charged devices and circuit boards can discharge without detection. Although this product features patented or proprietary protection circuitry, damage may occur on devices subjected to high energy ESD. Therefore, proper ESD precautions should be taken to avoid performance degradation or loss of functionality.

## PIN CONFIGURATION AND FUNCTION DESCRIPTIONS

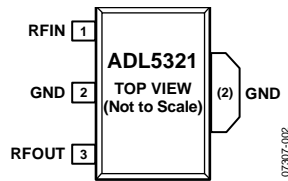

Figure 3. Pin Configuration

Table 5. Pin Function Descriptions

Pin No.	Mnemonic	Description
1	RFIN	RF Input. This pin requires a dc blocking capacitor.
2	GND	Ground. Connect this pin to a low impedance ground plane.
3	RFOUT	RF Output and Supply Voltage. DC bias is provided to this pin through an inductor that is connected to the external power supply. RF path requires a dc blocking capacitor.
Exposed Paddle		Expose Paddle. Internally connected to GND. Solder to a low impedance ground plane.

# TYPICAL PERFORMANCE CHARACTERISTICS

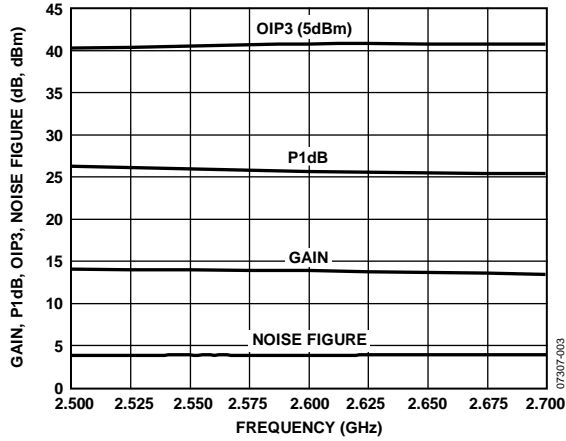

Figure 4. Gain, P1dB, OIP3, and Noise Figure vs. Frequency, 2.5 GHz to 2.7 GHz

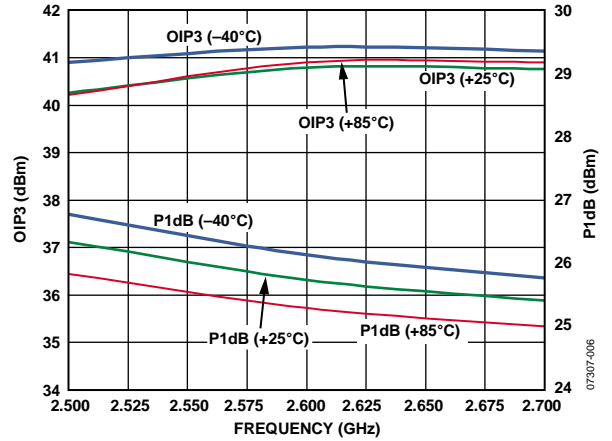

Figure 7. OIP3 and P1dB vs. Frequency and Temperature, 2.5 GHz to 2.7 GHz

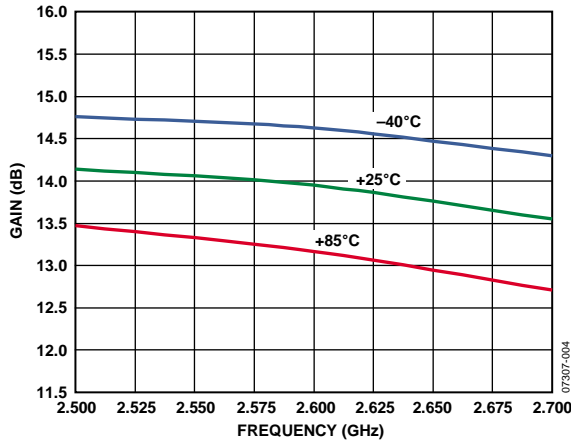

Figure 5. Gain vs. Frequency and Temperature, 2.5 GHz to 2.7 GHz

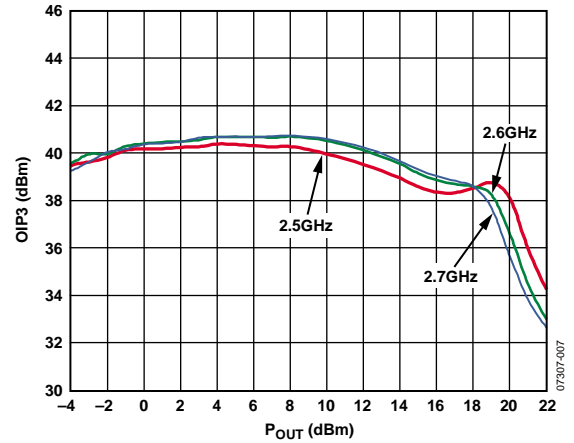

Figure 8. OIP3 vs. Pout and Frequency, 2.5 GHz to 2.7 GHz

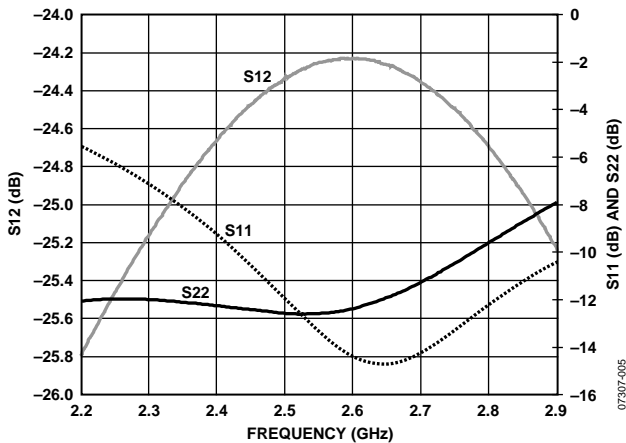

Figure 6. Reverse Isolation (S12), Input Return Loss (S11), and Output Return Loss (S22) vs. Frequency, 2.2 GHz to 2.9 GHz

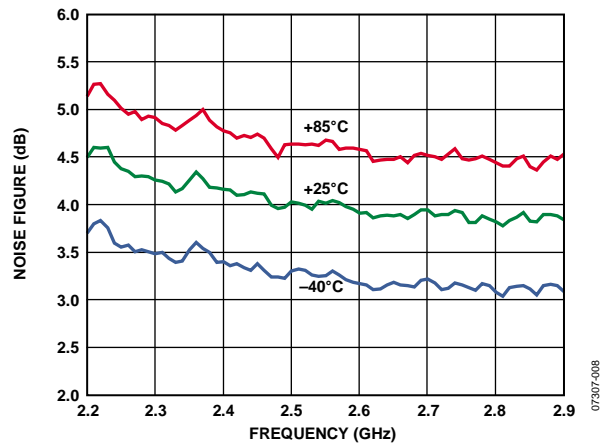

Figure 9. Noise Figure vs. Frequency and Temperature, 2.2 GHz to 2.9 GHz



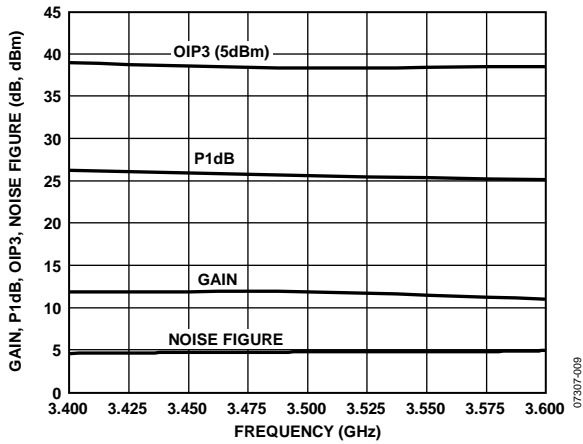

Figure 10. Gain, P1dB, OIP3, and Noise Figure vs. Frequency, 3.4 GHz to 3.6 GHz

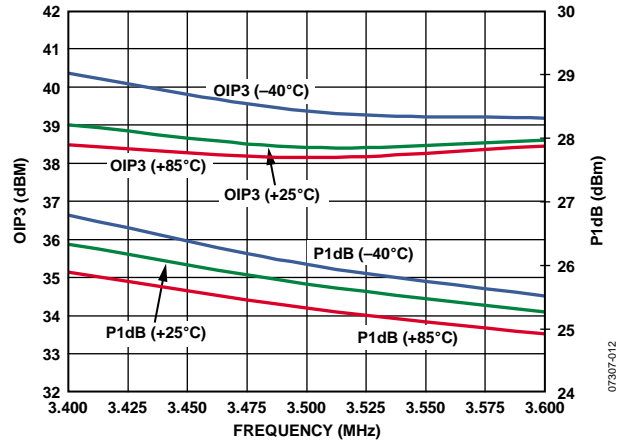

Figure 13. OIP3 and P1dB vs. Frequency and Temperature, 3.4 GHz to 3.6 GHz

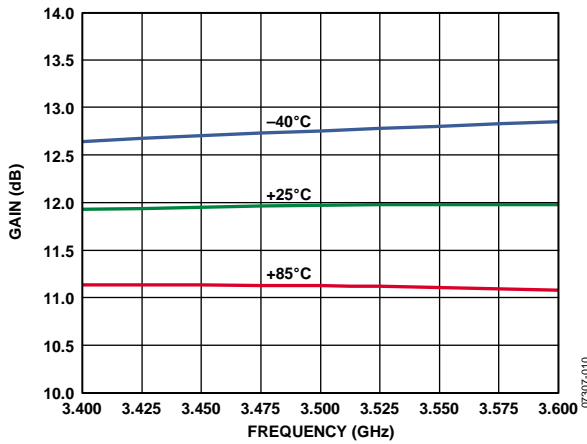

Figure 11. Gain vs. Frequency and Temperature, 3.4 GHz to 3.6 GHz

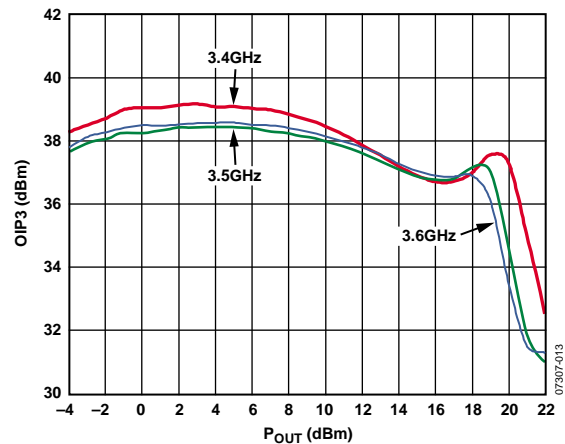

Figure 14. OIP3 vs. P<sub>OUT</sub> and Frequency, 3.4 GHz to 3.6 GHz

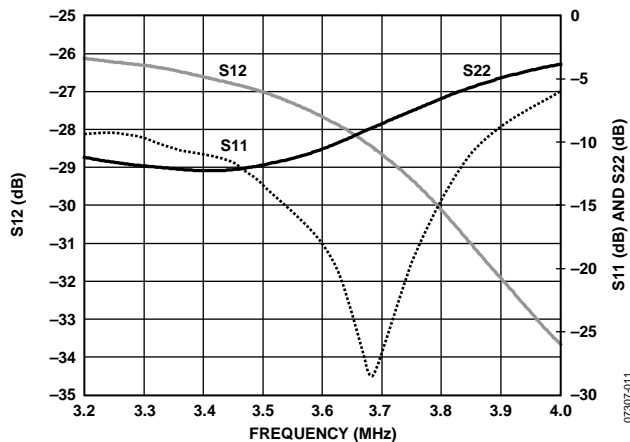

Figure 12. Reverse Isolation (S12), Input Return Loss (S11), and Output Return Loss (S22) vs. Frequency, 3.2 GHz to 4.0 GHz

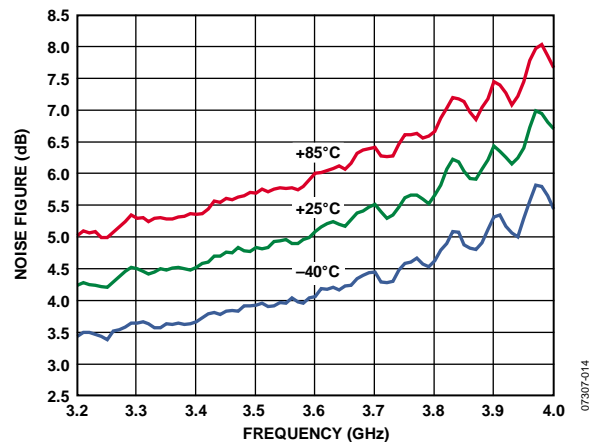

Figure 15. Noise Figure vs. Frequency and Temperature, 3.2 GHz to 4.0 GHz

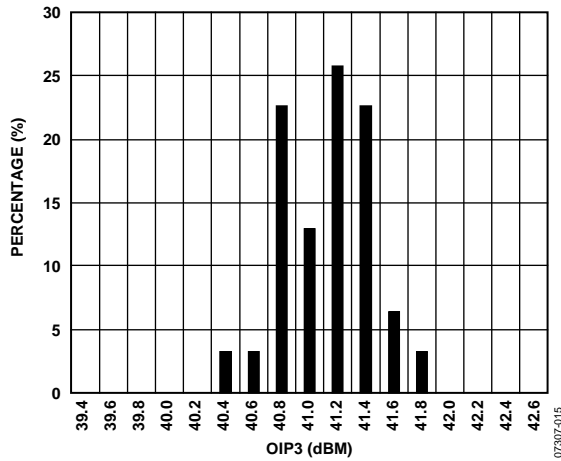

Figure 16. OIP3 Distribution at 2.6 GHz

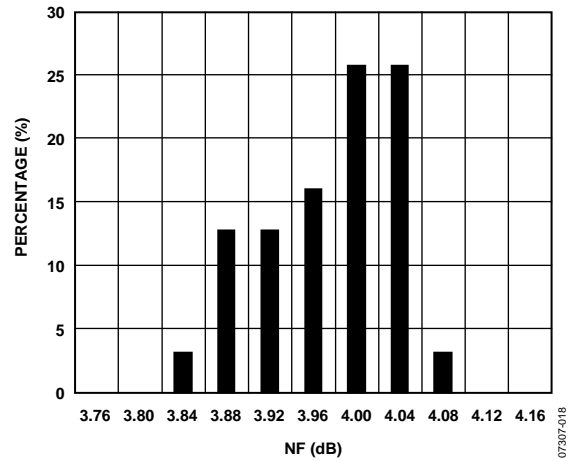

Figure 19. Noise Figure (NF) Distribution at 2.6 GHz

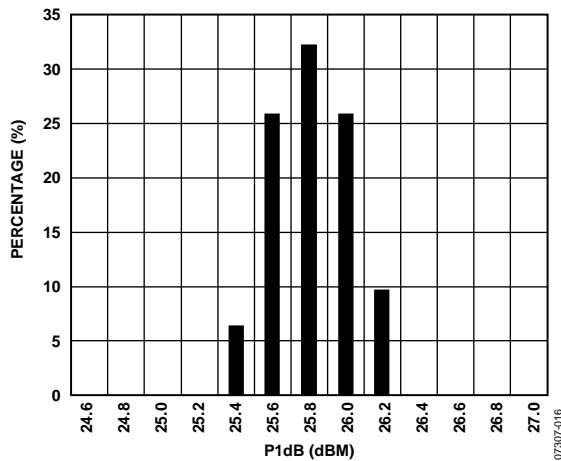

Figure 17. P1dB Distribution at 2.6 GHz

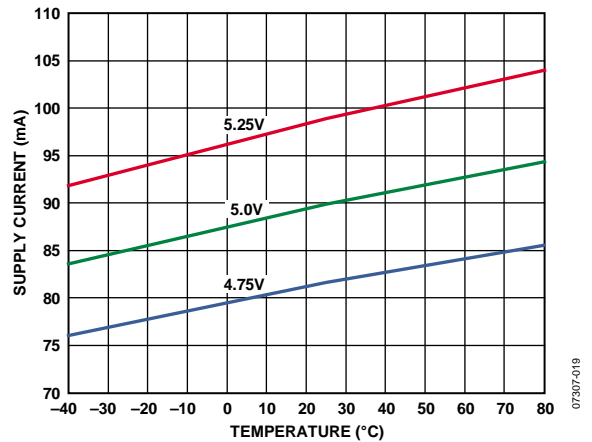

Figure 20. Supply Current vs. Temperature and Supply Voltage (Using 2.6 GHz Matching Components)

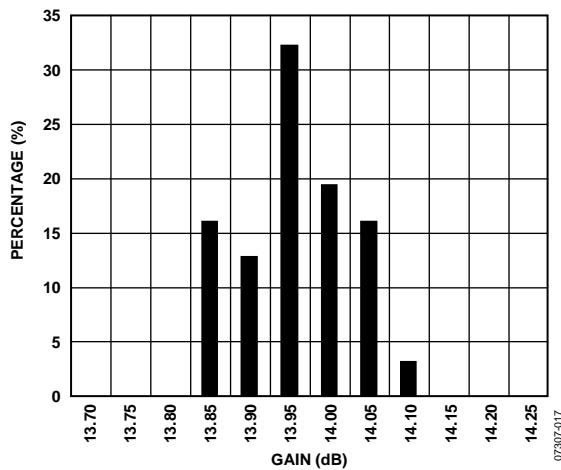

Figure 18. Gain Distribution at 2.6 GHz

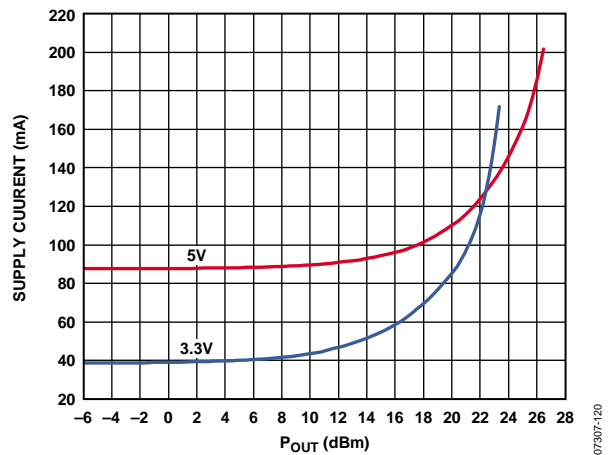

Figure 21. Supply Current vs. P<sub>OUT</sub> 3.3 V and 5 V (2.6 GHz Matching Components)

## HIGH TEMPERATURE AND 3.3 V OPERATION

The ADL5321 has excellent performance at temperatures above 85°C. At 105°C, the gain and P1dB decrease by 0.2 dB, the OIP3 decreases by 0.1 dB, and the noise figure increases by 0.31 dB compared with the data at 85°C. Figure 25 through Figure 27 show the performance at 105°C.

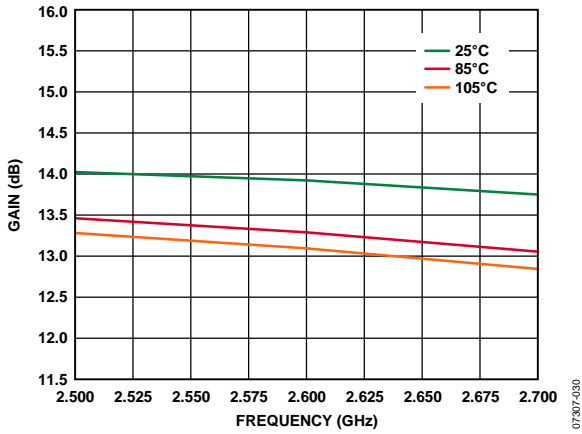

Figure 22. Gain vs. Frequency and Temperature, 5 V Supply, 2.5 GHz to 2.7 GHz

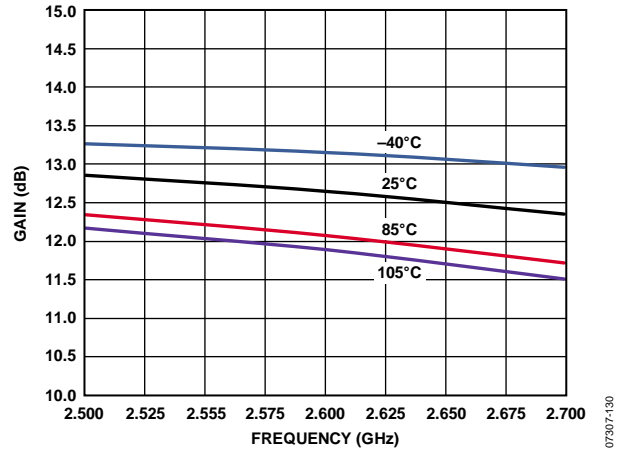

Figure 25. Gain vs. Frequency and Temperature, 3.3 V Supply, 2.5 GHz to 2.7 GHz

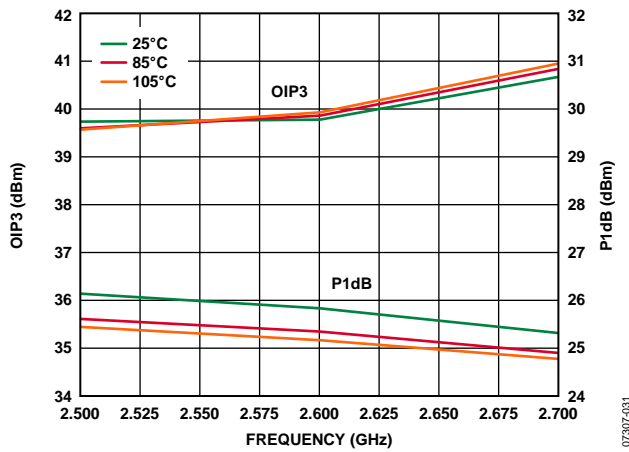

Figure 23. OIP3 and P1dB vs. Frequency and Temperature, 5 V Supply, 2.5 GHz to 2.7 GHz

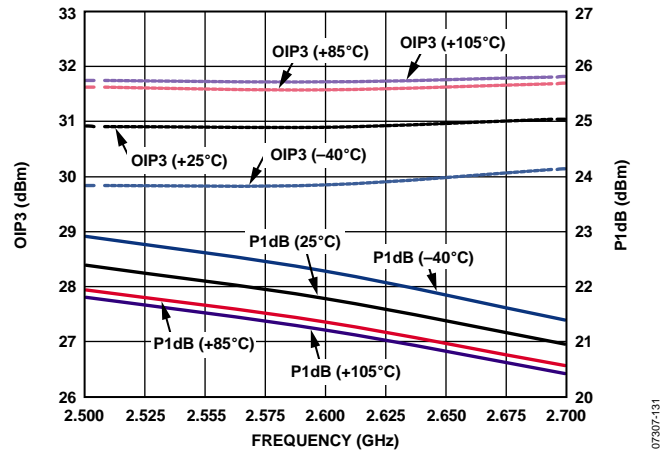

Figure 26. OIP3 and P1dB vs. Frequency and Temperature, 3.3 V Supply, 2.5 GHz to 2.7 GHz

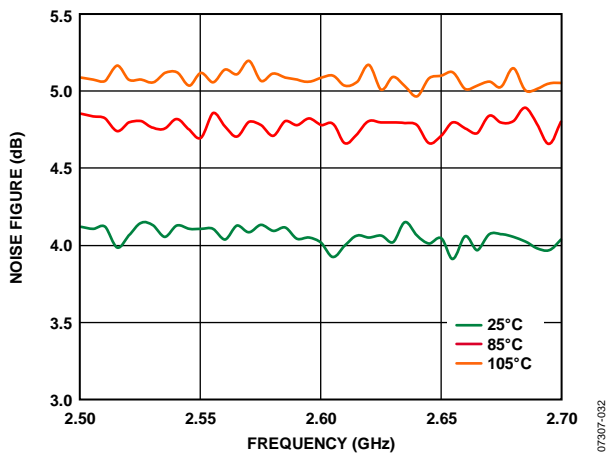

Figure 24. Noise Figure vs. Frequency and Temperature, 5 V Supply, 2.5 GHz to 2.7 GHz

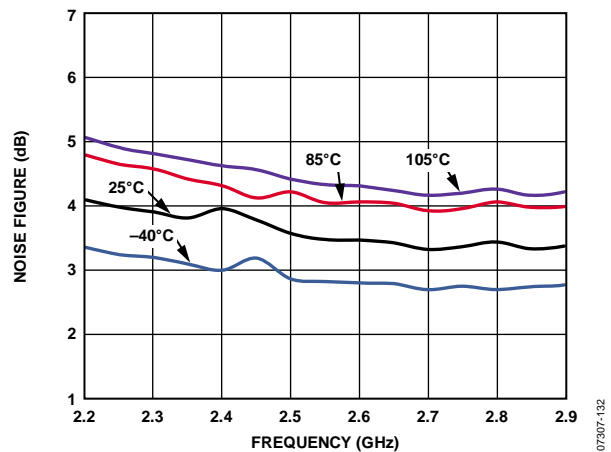

Figure 27. Noise Figure vs. Frequency and Temperature, 3.3 V Supply, 2.5 GHz to 2.7 GHz

## BASIC LAYOUT CONNECTIONS

The basic connections for operating the ADL5321 are shown in Figure 28.

Table 6 lists the required matching components. Capacitors C1, C2, C3, C4, and C7 are Murata GRM155 series (0402 size) and Inductor L1 is a Coilcraft 0603CS series (0603 size). For all frequency bands, the placement of C3 and C7 is critical. From 2500 MHz to 2700 MHz, the placement of C1 is also important. Table 7 lists the recommended component placement for various frequencies.

A 5 V dc bias is supplied through L1 that is connected to RFOUT (Pin 3). In addition to C4, 10 nF and 10  $\mu$ F power supply decoupling capacitors are also required. The typical current consumption for the ADL5321 is 90 mA.

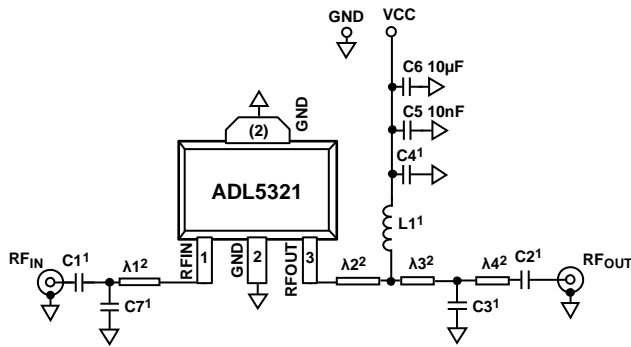

<sup>1</sup>SEE TABLE 5 FOR FREQUENCY SPECIFIC COMPONENTS.  
<sup>2</sup>SEE TABLE 6 FOR RECOMMENDED COMPONENT SPACING.

Figure 28. Basic Connections

07307-026

## SOLDERING INFORMATION AND RECOMMENDED PCB LAND PATTERN

Figure 29 shows the recommended land pattern for the ADL5321. To minimize thermal impedance, the exposed paddle on the SOT-89 package underside is soldered down to a ground plane along with (GND) Pin 2. If multiple ground layers exist, they should be stitched together using vias. For more information on land pattern design and layout, refer to the AN-772 Application Note, A Design and Manufacturing Guide for the Lead Frame Chip Scale Package (LFCSP).

This land pattern, on the ADL5321 evaluation board, provides a measured thermal resistance ( $\theta_{JA}$ ) of 35°C/W. To measure  $\theta_{JA}$ , the temperature at the top of the SOT-89 package is found with an IR temperature gun. Thermal simulation suggests a junction temperature 10°C higher than the top of package temperature. With additional ambient temperature and I/O power measurements,  $\theta_{JA}$  could be determined.

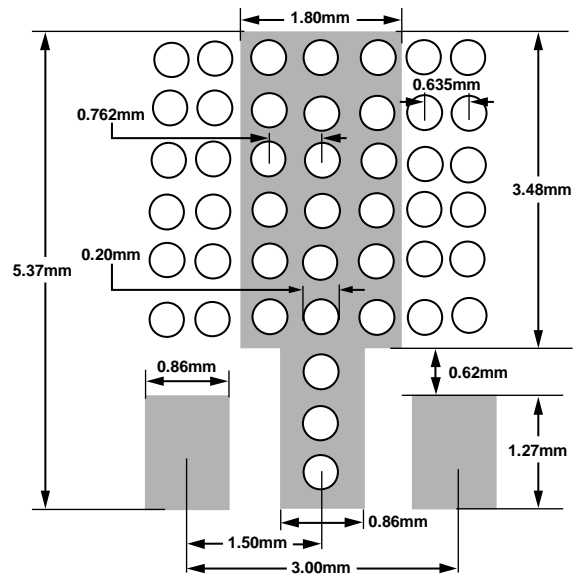

Figure 29. Recommended Land Pattern

07307-051

Table 6. Recommended Components for Basic Connections

Frequency (MHz)	C1 (pF)	C2 (pF)	C3 (pF)	C4 (pF)	C7 (pF)	L1 (nH)
2500 to 2700	1.0	10	1.2	10	Open	9.5
3400 to 3850	10	10	1.2	10	1.0	9.5

Table 7. Matching Component Spacing

Frequency (MHz)	$\lambda$ 1 (mils)	$\lambda$ 2 (mils)	$\lambda$ 3 (mils)	$\lambda$ 4 (mils)
2500 to 2700	240	75	89	325
3400 to 3850	90	35	40	416

## MATCHING PROCEDURE

The ADL5321 is designed to achieve excellent gain and IP3 performance. To achieve this, both input and output matching networks must present specific impedance to the device. The matching components listed in Table 6 were chosen to provide -14 dB input return loss while maximizing OIP3. The load-pull plots (see Figure 30, Figure 31, and Figure 32) show the load impedance points on the Smith chart where optimum OIP3, gain, and output power can be achieved. These load impedance values (that is, the impedance that the device sees when looking into the output matching network) are listed in Table 8 and Table 9 for maximum gain and maximum OIP3, respectively. The contours show how each parameter degrades as it is moved away from the optimum point.

From the data shown in Table 8 and Table 9, it becomes clear that maximum gain and maximum OIP3 do not occur at the same impedance. This can also be seen on the load-pull contours in Figure 30 through Figure 32. Therefore, output matching generally involves compromising between gain and OIP3. In addition, the load-pull plots demonstrate that the quality of the output impedance match must be compromised to optimize gain and/or OIP3. In most applications where line lengths are short and where the next device in the signal chain presents a low input return loss, compromising on the output match is acceptable.

To adjust the output match for operation at a different frequency or if a different trade-off between OIP3, gain, and output impedance is desired, the following procedure is recommended.

For example, to optimize the ADL5321 for optimum OIP3 and gain at 2300 MHz, use the following steps:

1. Install the recommended tuning components for a 2500 MHz to 2700 MHz tuning band, but do not install C3 and C7.
2. Connect the evaluation board to a vector network analyzer so that input and output return loss can be viewed simultaneously.
3. Starting with the recommended values and positions for C3 and C7, adjust the positions of these capacitors along the transmission line until the return loss and gain are acceptable. Push-down capacitors that are mounted on small sticks can be used in this case as an alternative to soldering. If moving the component positions does not yield satisfactory results, then the values of C3 and C7 should be increased or decreased (most likely increased in this case because the user is tuning for a lower frequency). Repeat the process.
4. Once the desired gain and return loss are realized, OIP3 should be measured. It may be necessary to go back and forth between return loss/gain and OIP3 measurements (probably compromising most on output return loss) until an acceptable compromise is achieved.

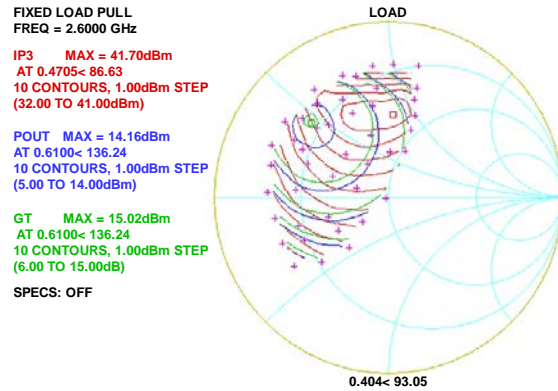

Figure 30. Load-Pull Contours, 2600 MHz

07307-022

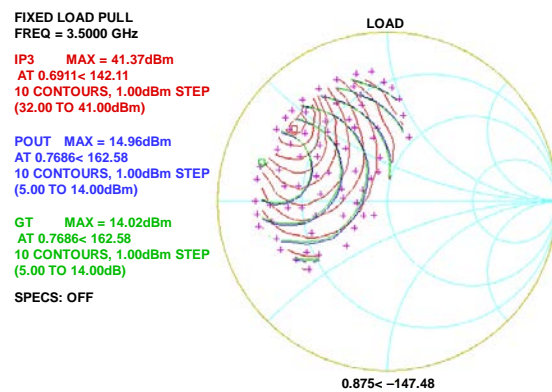

Figure 31. Load-Pull Contours, 3500 MHz

07307-023

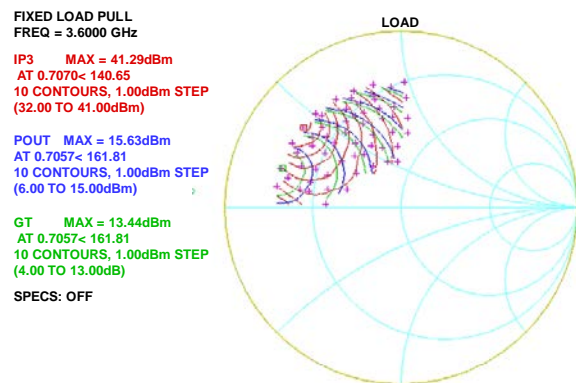

Figure 32. Load-Pull Contours, 3600 MHz

07307-024

Table 8. Load Conditions for Gain<sub>MAX</sub>

Frequency (MHz)	$\Gamma_{Load}$ (Magnitude)	$\Gamma_{Load}$ (°)	Gain <sub>MAX</sub> (dB)
2600	0.6100	136.24	15.02
3500	0.7686	162.58	14.02
3600	0.7057	161.81	13.44

Table 9. Load Conditions for OIP<sub>3MAX</sub>

Frequency (MHz)	$\Gamma_{Load}$ (Magnitude)	$\Gamma_{Load}$ (°)	IP <sub>3 MAX</sub> (dBm)
2600	0.4705	86.63	41.7
3500	0.6911	142.11	41.37
3600	0.7070	140.65	41.29

**WiMAX OPERATION**

Figure 33 shows a plot of adjacent channel leakage ratio (ACLR) vs. P<sub>OUT</sub> for the ADL5321. The signal type used is a WiMAX, 64 QAM, single carrier with a 10 MHz channel bandwidth. This signal is generated by a WiMAX-enabled source and followed with suitable band-pass filtering. The band-pass filter helps reduce the adjacent and alternate channel noise and distortion out of the signal generator down to -63 dB in the adjacent channels and -76 dB in the alternate channels at 2.6 GHz and -60 dB at 3.5 GHz.

Below an output power of 7 dBm, measured ADL5321 output spectral performance is limited by the signal quality from the signal source used (-63 dB at 2.6 GHz and -60 dB at 3.5 GHz). At high power operation, input power to the ADL5321 is 1 dBm for 15 dBm output power and the source ACLR is -60.2 dB. It is expected that with a better signal source, the ADL5321 output spectral quality improves further, especially at output power levels ≤10 dBm. For instance, the ADL5373 quadrature modulator measured ACLR is -69 dB for an output power of -10 dBm.

For output powers up to 10 dBm rms, the ADL5321 adds very little distortion to the output spectrum. At 2.6 GHz, the ACLR is -59 dB and a relative constellation error of -46.6 dB (<0.5% EVM) at an output power of 10 dBm rms.

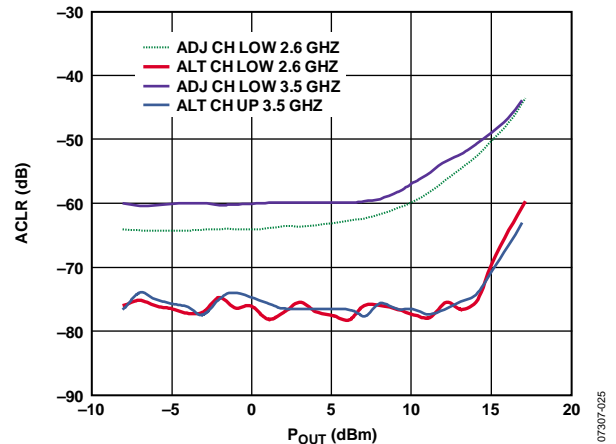

Figure 33. ACLR vs. P<sub>OUT</sub>, WiMAX 64 QAM, 10 MHz Bandwidth, Single Carrier

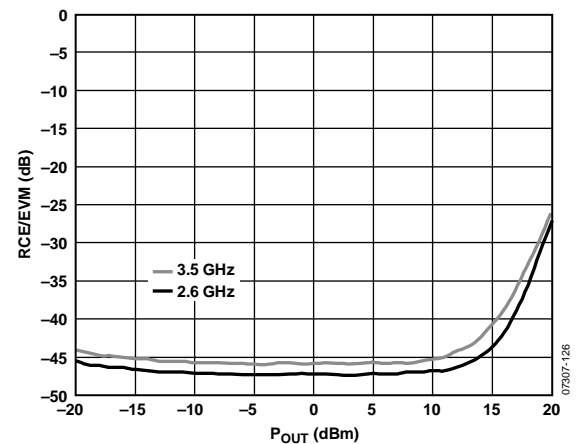

Figure 34. RCE/EVM vs. P<sub>OUT</sub>, WiMAX 64 QAM, 10 MHz Bandwidth, Single Carrier

## EVALUATION BOARD

The schematic of the [ADL5321](#) evaluation board is shown in Figure 35. This evaluation board uses 25 mil wide traces and is made from IS410 material (lead-free version of FR4). The evaluation board comes tuned for operation in the 2500 MHz to 2700 MHz tuning band. Tuning options for other frequency bands

are also provided in Table 10. The recommended placement for these components is provided in Table 11. The inputs and outputs should be ac-coupled with appropriately sized capacitors. DC bias is provided to the amplifier via an inductor connected to the RFOUT pin. A bias voltage of 5 V is recommended.

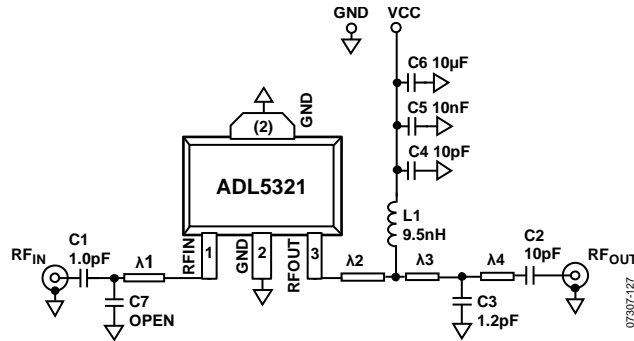

Figure 35. Evaluation Board, 2500 MHz to 2700 MHz

Table 10. Evaluation Board Configuration Options

Component	Function	2500 MHz to 2700 MHz	3400 MHz to 3850 MHz
C1, C2	AC coupling capacitors	C1 = 0402, 1.0 pF C2 = 0402, 10 pF	C1 = 0402, 10 pF C2 = 0402, 10 pF
C4, C5, C6	Power supply bypassing capacitors	C4 = 0603, 10 pF C5 = 0603, 10 nF C6 = 1206, 10 μF	C4 = 0603, 10 pF C5 = 0603, 10 nF C6 = 1206, 10 μF
L1	DC bias inductor	0603, 9.5 nH	0603, 9.5 nH
C3, C7	Tuning capacitors	C3 = 0402, 1.2 pF C7 = 0402, open	C3 = 0402, 1.2 pF C7 = 0402, 1.0 pF
VCC, GND	Power supply connections	VCC, red test loop GND, black test loop	VCC, red test loop GND, black test loop

Table 11. Recommended Component Spacing on Evaluation Board

Frequency (MHz)	λ1 (mils)	λ2 (mils)	λ3 (mils)	λ4 (mils)
2500 to 2700	240	75	89	325
3400 to 3850	90	35	40	416

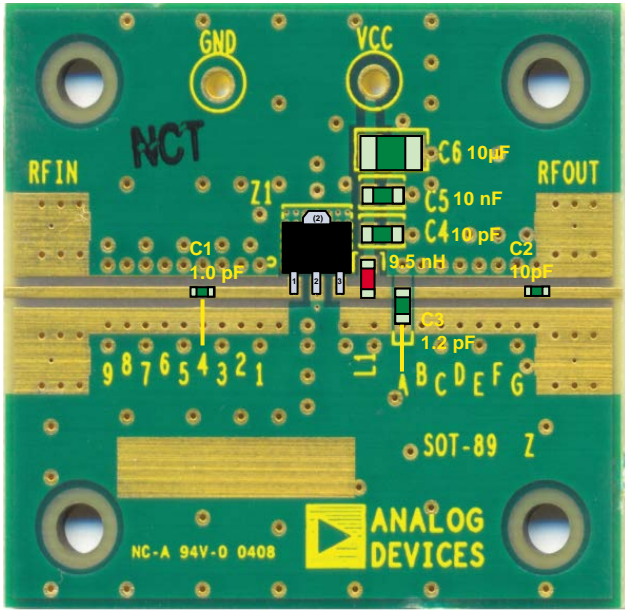

07307-028

Figure 36. Evaluation Board Layout and Default Component Placement for Operation from 2500 MHz to 2700 MHz (Note: C7 Is Not Placed)

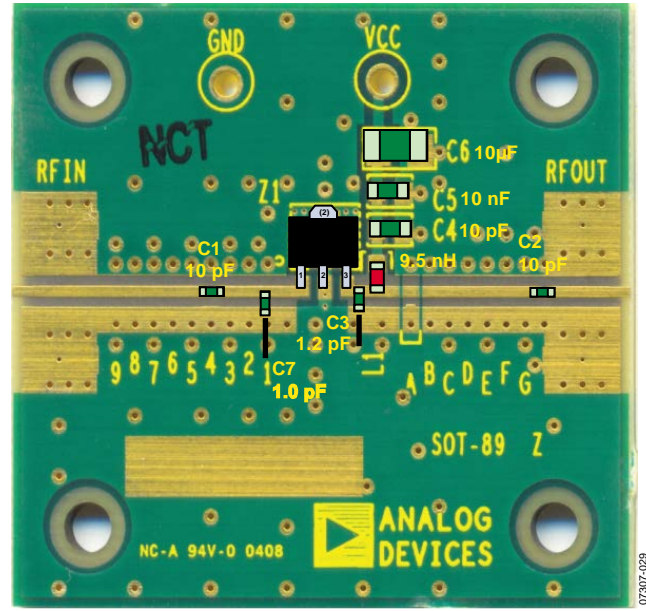

07307-029

Figure 37. Evaluation Board Layout and Component Placement for Operation from 3400 MHz to 3850 MHz



OUTLINE DIMENSIONS

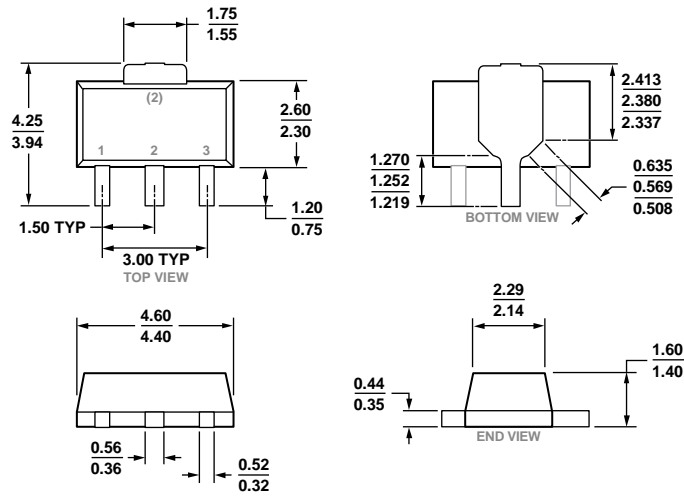

COMPLIANT TO JEDEC STANDARDS TO-243

Figure 38. 3-Lead Small Outline Transistor Package [SOT-89] (RK-3)

Dimensions shown in millimeters

ORDERING GUIDE

Model <sup>1</sup>	Temperature Range	Package Description	Package Option
ADL5321ARKZ-R7	-40°C to +105°C	3-Lead SOT-89, 7" Tape and Reel	RK-3
ADL5321-EVALZ		Evaluation Board	

<sup>1</sup> Z = RoHS Compliant Part.