

NLAST4051

Analog Multiplexer/ Demultiplexer

TTL Compatible, Single-Pole, 8-Position Plus Common Off

The NLAST4051 is an improved version of the MC14051 and MC74HC4051 fabricated in sub-micron Silicon Gate CMOS technology for lower $R_{DS(on)}$ resistance and improved linearity with low current. This device may be operated either with a single supply or dual supply up to ± 3 V to pass a 6 V_{PP} signal without coupling capacitors.

When operating in single supply mode, it is only necessary to tie V_{EE} , pin 7 to ground. For dual supply operation, V_{EE} is tied to a negative voltage, not to exceed maximum ratings. Translation is provided in the device, the Address and Inhibit are standard TTL level compatible. For CMOS compatibility see NLAS4051. Pin for pin compatible with all industry standard versions of '4051.'

Features

- Improved $R_{DS(on)}$ Specifications
- Pin for Pin Replacement for MAX4051 and MAX4051A
 - One Half the Resistance Operating at 5.0 V
- Single or Dual Supply Operation
 - Single 3.0 – 5.0 V Operation, or Dual ± 3 V Operation
 - With V_{CC} of 3.0 to 3.3 V, Device Can Interface with 1.8 V Logic, No Translators Needed
 - Address and Inhibit Logic are Over-Voltage Tolerant and May Be Driven Up +6 V Regardless of V_{CC}
- Address and Inhibit Pins Standard TTL Compatible
 - Greatly Improved Noise Margin Over MAX4051 and MAX4051A
 - True TTL Compatibility $V_{IL} = 0.8$ V, $V_{IH} = 2.0$ V
- Improved Linearity Over Standard HC4051 Devices
- Space Saving TSSOP Package
- NLV Prefix for Automotive and Other Applications Requiring Unique Site and Control Change Requirements; AEC-Q100 Qualified and PPAP Capable
- These Devices are Pb-Free, Halogen Free/BFR Free and are RoHS Compliant

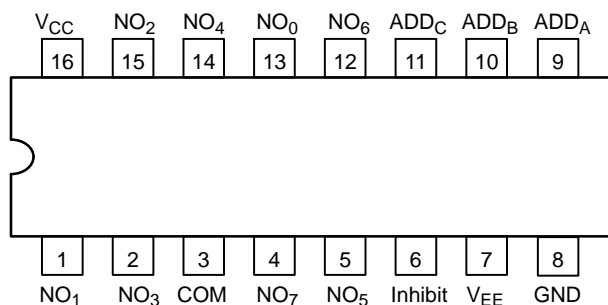
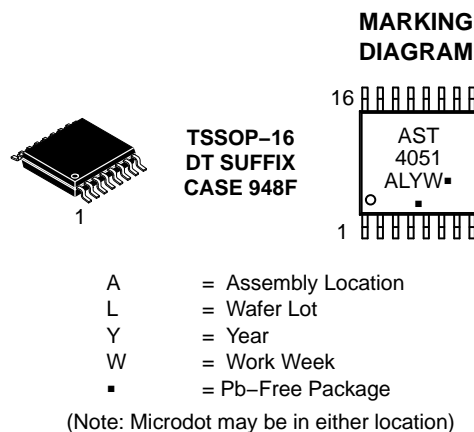

Figure 1. Pin Connection
(Top View)



ON Semiconductor®

www.onsemi.com



ORDERING INFORMATION

See detailed ordering and shipping information in the package dimensions section on page 10 of this data sheet.

NLAST4051

TRUTH TABLE

Inhibit	Address			ON SWITCHES*
	C	B	A	
1	X don't care	X don't care	X don't care	All switches open
0	0	0	0	COM-NO ₀
0	0	0	1	COM-NO ₁
0	0	1	0	COM-NO ₂
0	0	1	1	COM-NO ₃
0	1	0	0	COM-NO ₄
0	1	0	1	COM-NO ₅
0	1	1	0	COM-NO ₆
0	1	1	1	COM-NO ₇

*NO and COM pins are identical and interchangeable. Either may be considered an input or output; signals pass equally well in either direction.

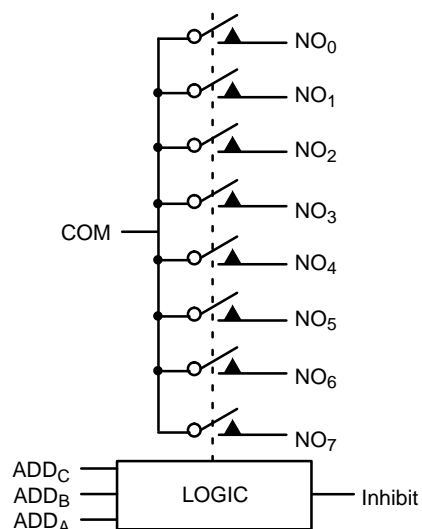

Figure 2. Logic Diagram

MAXIMUM RATINGS

Symbol	Parameter	Value	Unit
V _{EE}	Negative DC Supply Voltage (Referenced to GND)	-7.0 to +0.5	V
V _{CC}	Positive DC Supply Voltage (Note 1) (Referenced to GND) (Referenced to V _{EE})	-0.5 to +7.0 -0.5 to +7.0	V
V _{IS}	Analog Input Voltage	V _{EE} -0.5 to V _{CC} +0.5	V
V _{IN}	Digital Input Voltage (Referenced to GND)	-0.5 to 7.0	V
I	DC Current, Into or Out of Any Pin	±50	mA
T _{STG}	Storage Temperature Range	-65 to +150	°C
T _L	Lead Temperature, 1 mm from Case for 10 Seconds	260	°C
T _J	Junction Temperature under Bias	+150	°C
θ _{JA}	Thermal Resistance	164	°C/W
P _D	Power Dissipation in Still Air	450	mW
MSL	Moisture Sensitivity	Level 1	
F _R	Flammability Rating (Oxygen Index: 30% – 35%)	UL 94 V-0 @ 0.125 in	
V _{ESD}	ESD Withstand Voltage (Human Body Model (Note 2) Machine Model (Note 3) Charged Device Model (Note 4))	> 2000 > 200 > 1000	V
I _{LATCHUP}	Latchup Performance (Above V _{CC} and Below GND at 125°C (Note 5))	±300	mA

Stresses exceeding those listed in the Maximum Ratings table may damage the device. If any of these limits are exceeded, device functionality should not be assumed, damage may occur and reliability may be affected.

1. The absolute value of V_{CC} ± |V_{EE}| ≤ 7.0.
2. Tested to EIA/JESD22-A114-A.
3. Tested to EIA/JESD22-A115-A.
4. Tested to JESD22-C101-A.
5. Tested to EIA/JESD78.

NLAST4051

RECOMMENDED OPERATING CONDITIONS

Symbol	Parameter	Min	Max	Unit
V_{EE}	Negative DC Supply Voltage (Referenced to GND)	-5.5	GND	V
V_{CC}	Positive DC Supply Voltage (Referenced to GND) (Referenced to V_{EE})	2.5 2.5	5.5 6.6	V
V_{IS}	Analog Input Voltage	V_{EE}	V_{CC}	V
V_{IN}	Digital Input Voltage (Note 6) (Referenced to GND)	0	5.5	V
T_A	Operating Temperature Range, All Package Types	-55	125	°C
t_r, t_f	Input Rise/Fall Time (Channel Select or Enable Inputs) $V_{CC} = 3.0 \text{ V} \pm 0.3 \text{ V}$ $V_{CC} = 5.0 \text{ V} \pm 0.5 \text{ V}$	0 0	100 20	ns/V

Functional operation above the stresses listed in the Recommended Operating Ranges is not implied. Extended exposure to stresses beyond the Recommended Operating Ranges limits may affect device reliability.

6. Unused digital inputs may not be left open. All digital inputs must be tied to a high-logic voltage level or a low-logic input voltage level.

DC CHARACTERISTICS – Digital Section (Voltages Referenced to GND)

Symbol	Parameter	Condition	V_{CC} V	Guaranteed Limit			Unit
				-55 to 25°C	≤ 85°C	≤ 125°C	
V_{IH}	Minimum High-Level Input Voltage, Address or Inhibit Inputs		3.0	1.6	1.6	1.6	V
			4.5	2.0	2.0	2.0	
			5.5	2.0	2.0	2.0	
V_{IL}	Maximum Low-Level Input Voltage, Address or Inhibit Inputs		3.0	0.5	0.5	0.5	V
			4.5	0.8	0.8	0.8	
			5.5	0.8	0.8	0.8	
I_{IN}	Maximum Input Leakage Current, Address or Inhibit Inputs	$V_{IN} = 6.0$ or GND	0 V to 6.0 V	±0.1	±1.0	±1.0	μA
I_{CC}	Maximum Quiescent Supply Current (per Package)	Address or Inhibit and $V_{IS} = V_{CC}$ or GND	6.0	4.0	40	80	μA

Product parametric performance is indicated in the Electrical Characteristics for the listed test conditions, unless otherwise noted. Product performance may not be indicated by the Electrical Characteristics if operated under different conditions.

DC ELECTRICAL CHARACTERISTICS – Analog Section

Symbol	Parameter	Test Conditions	V_{CC} V	V_{EE} V	Guaranteed Limit			Unit
					-55 to 25°C	≤ 85°C	≤ 125°C	
R_{ON}	Maximum "ON" Resistance	$V_{IN} = V_{IL}$ or V_{IH} $V_{IS} = (V_{EE}$ to $V_{CC})$ $ I_S = 10 \text{ mA}$ (Figures 4 thru 9)	3.0	0	86	108	120	Ω
			4.5	0	37	46	55	
			3.0	-3.0	26	33	37	
ΔR_{ON}	Maximum Difference in "ON" Resistance Between Any Two Channels in the Same Package	$V_{IN} = V_{IL}$ or V_{IH} , $ I_S = 10 \text{ mA}$, $V_{IS} = 2.0 \text{ V}$ $V_{IS} = 3.0 \text{ V}$ $V_{IS} = 2.0 \text{ V}$	3.0	0	15	20	20	Ω
			4.5	0	13	18	18	
			3.0	-3.0	10	15	15	
$R_{flat(ON)}$	ON Resistance Flatness	$V_{COM} = 1, 2, 3.5 \text{ V}$ $V_{COM} = 2, 0, 2 \text{ V}$	4.5 3.0	3.0	4 2	4 2	5 3	Ω
$I_{NC(OFF)}$ $I_{NO(OFF)}$	Maximum Off-Channel Leakage Current	Switch Off $V_{IN} = V_{IL}$ or V_{IH} $V_{IO} = V_{CC} - 1.0 \text{ V}$ or $V_{EE} + 1.0 \text{ V}$ (Figure 17)	6.0	0	0.1	5.0	100	nA
			3.0	-3.0	0.1	5.0	100	
$I_{COM(ON)}$	Maximum On-Channel Leakage Current, Channel-to-Channel	Switch On $V_{IO} = V_{CC} - 1.0 \text{ V}$ or $V_{EE} + 1.0 \text{ V}$ (Figure 17)	6.0	0	0.1	5.0	100	nA
			3.0	-3.0	0.1	5.0	100	

NLAST4051

AC CHARACTERISTICS (Input $t_r = t_f = 3$ ns)

Symbol	Parameter	Test Conditions	V_{CC} V	V_{EE} V	Guaranteed Limit				Unit
					-55 to 25°C		≤ 85°C	≤ 125°C	
					Min	Typ*			
t_{BBM}	Minimum Break-Before-Make Time	$V_{IN} = V_{IL}$ or V_{IH} $V_{IS} = V_{CC}$ $R_L = 300 \Omega$, $C_L = 35$ pF (Figure 19)	3.0 4.5 3.0	0.0 0.0 -3.0	1.0 1.0 1.0	6.5 5.0 3.5	- - -	- - -	ns

*Typical Characteristics are at 25°C.

AC CHARACTERISTICS ($C_L = 35$ pF, Input $t_r = t_f = 3$ ns)

Symbol	Parameter	V_{CC} V	V_{EE} V	Guaranteed Limit						Unit	
				-55 to 25°C			≤ 85°C		≤ 125°C		
				Min	Typ	Max	Min	Max	Min		Max
t_{TRANS}	Transition Time (Address Selection Time) (Figure 18)	2.5 3.0 4.5 3.0	0 0 0 -3.0			40 28 23 23		45 30 25 25		50 35 30 28	ns
t_{ON}	Turn-on Time (Figures 14, 15, 20, and 21) Enable to N_O or N_C	2.5 3.0 4.5 3.0	0 0 0 -3.0			40 28 23 23		45 30 25 25		50 35 30 28	ns
t_{OFF}	Turn-off Time (Figures 14, 15, 20, and 21) Enable to N_O or N_C	2.5 3.0 4.5 3.0	0 0 0 -3.0			40 28 23 23		45 30 25 25		50 35 30 28	ns

		Typical @ 25°C, $V_{CC} = 5.0$ V		
C_{IN}	Maximum Input Capacitance, Select Inputs	8		pF
C_{NO} or C_{NC}	Analog I/O	10		
C_{COM}	Common I/O	10		
$C_{(ON)}$	Feedthrough	1.0		

ADDITIONAL APPLICATION CHARACTERISTICS (GND = 0 V)

Symbol	Parameter	Condition	V_{CC} V	V_{EE} V	Typ	Unit
					25°C	
BW	Maximum On-Channel Bandwidth or Minimum Frequency Response	$V_{IS} = \frac{1}{2}(V_{CC} - V_{EE})$ Source Amplitude = 0 dBm (Figures 10 and 22)	3.0 4.5 6.0 3.0	0.0 0.0 0.0 -3.0	80 90 95 95	MHz
V_{ISO}	Off-Channel Feedthrough Isolation	$f = 100$ kHz; $V_{IS} = \frac{1}{2}(V_{CC} - V_{EE})$ Source = 0 dBm (Figures 12 and 22)	3.0 4.5 6.0 3.0	0.0 0.0 0.0 -3.0	-93 -93 -93 -93	dB
V_{ONL}	Maximum Feedthrough On Loss	$V_{IS} = \frac{1}{2}(V_{CC} - V_{EE})$ Source = 0 dBm (Figures 10 and 22)	3.0 4.5 6.0 3.0	0.0 0.0 0.0 -3.0	-2 -2 -2 -2	dB
Q	Charge Injection	$V_{IN} = V_{CC}$ to V_{EE} , $f_{IS} = 1$ kHz, $t_r = t_f = 3$ ns $R_{IS} = 0 \Omega$, $C_L = 1000$ pF, $Q = C_L * \Delta V_{OUT}$ (Figures 16 and 23)	5.0 3.0	0.0 -3.0	9.0 12	pC
THD	Total Harmonic Distortion THD + Noise	$f_{IS} = 1$ MHz, $R_L = 10$ K Ω , $C_L = 50$ pF, $V_{IS} = 5.0$ V _{PP} sine wave $V_{IS} = 6.0$ V _{PP} sine wave (Figure 13)	6.0 3.0	0.0 -3.0	0.10 0.05	%

TYPICAL CHARACTERISTICS

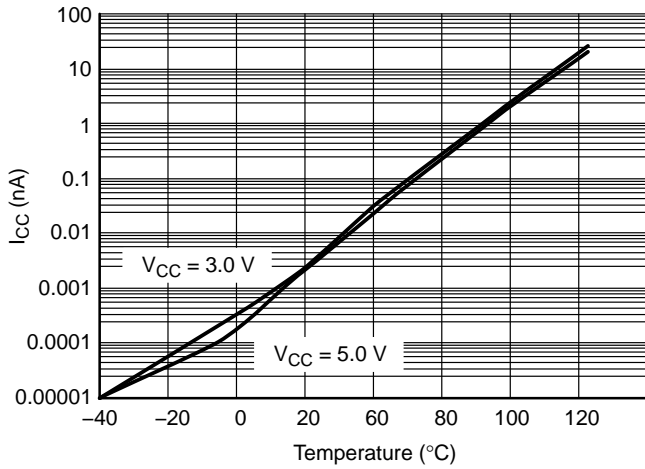

Figure 3. I_{CC} versus Temp, $V_{CC} = 3\text{ V}$ and 5 V

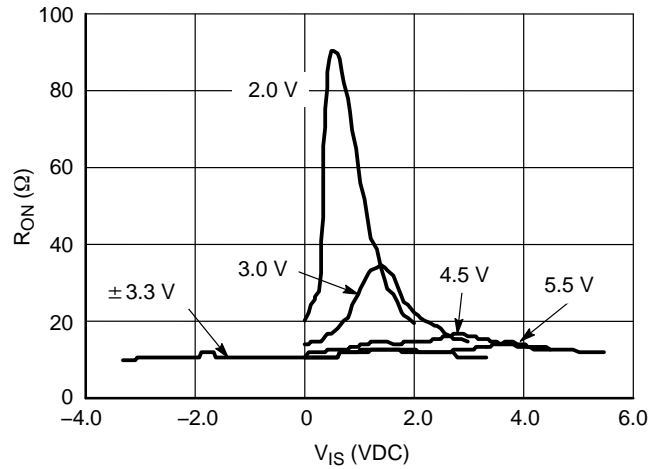

Figure 4. R_{ON} versus V_{CC} , Temp = 25°C

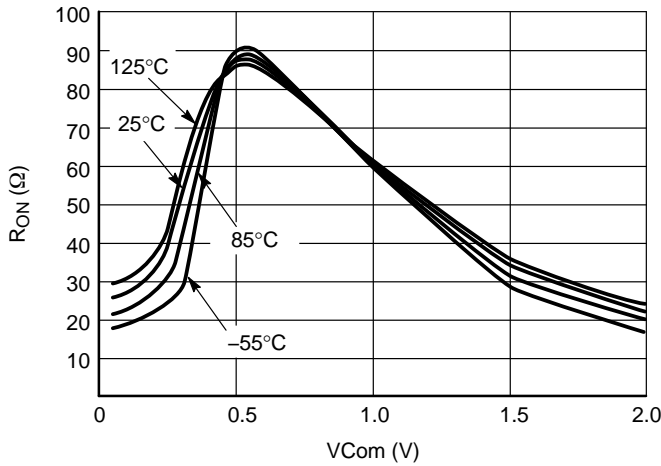

Figure 5. Typical On Resistance
 $V_{CC} = 2.0\text{ V}$, $V_{EE} = 0\text{ V}$

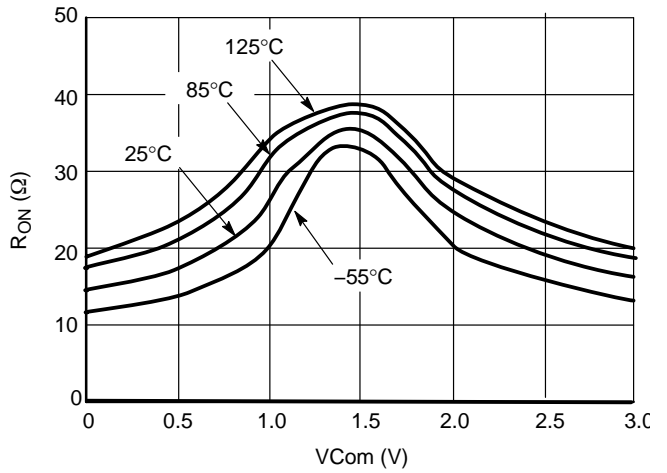

Figure 6. Typical On Resistance
 $V_{CC} = 3.0\text{ V}$, $V_{EE} = 0\text{ V}$

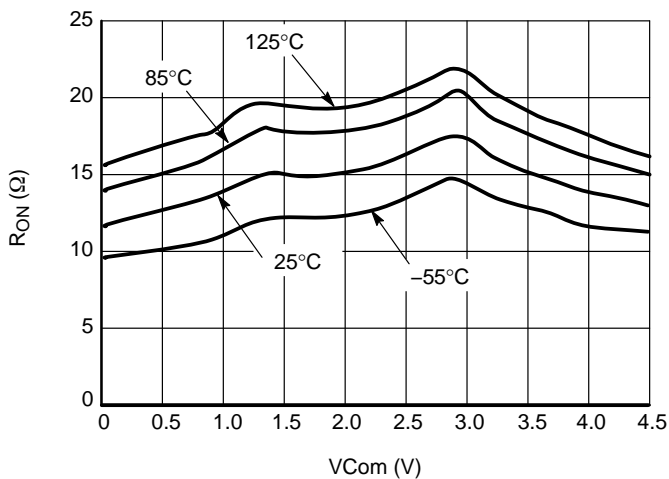

Figure 7. Typical On Resistance
 $V_{CC} = 4.5\text{ V}$, $V_{EE} = 0\text{ V}$

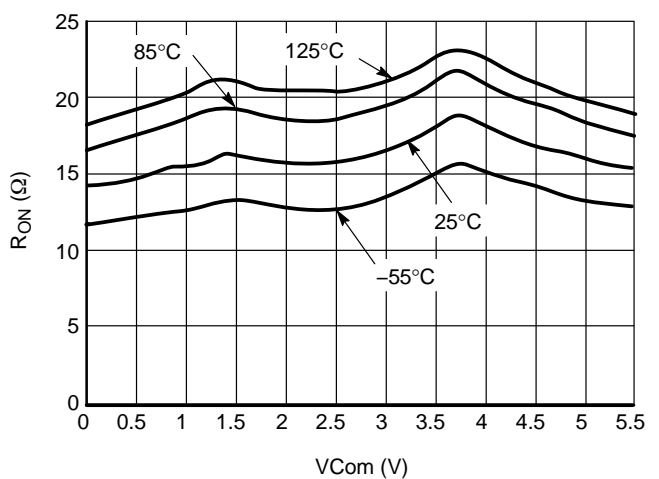

Figure 8. Typical On Resistance
 $V_{CC} = 5.5\text{ V}$, $V_{EE} = 0\text{ V}$

TYPICAL CHARACTERISTICS

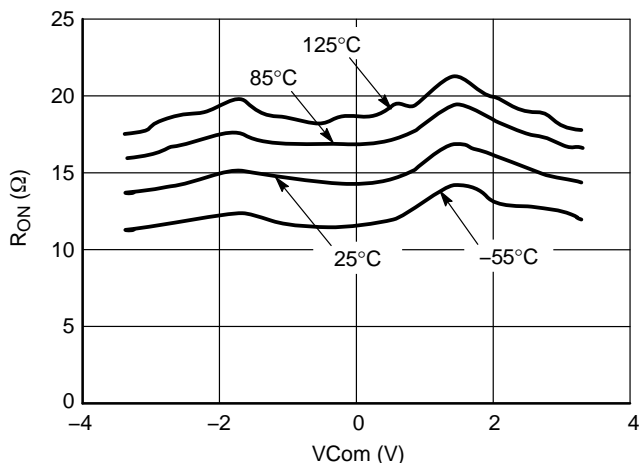

Figure 9. Typical On Resistance
 $V_{CC} = 3.3\text{ V}, V_{EE} = -3.3\text{ V}$

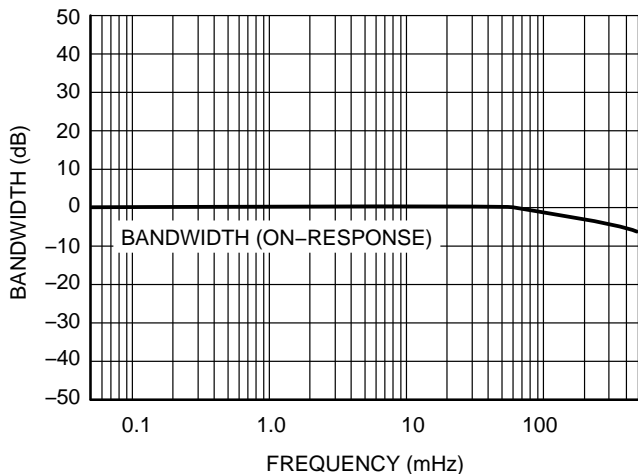

Figure 10. Bandwidth

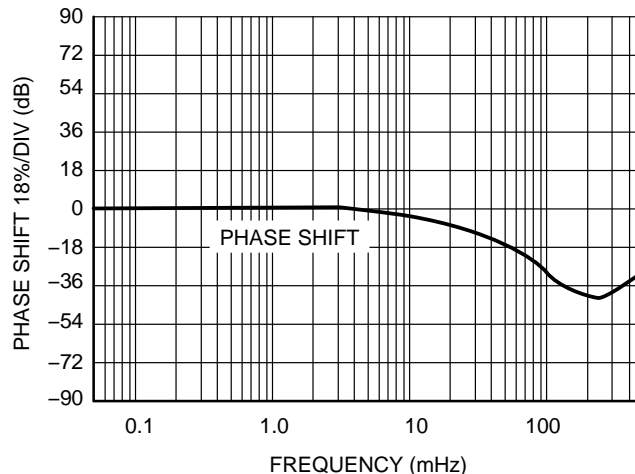

Figure 11. Phase Shift

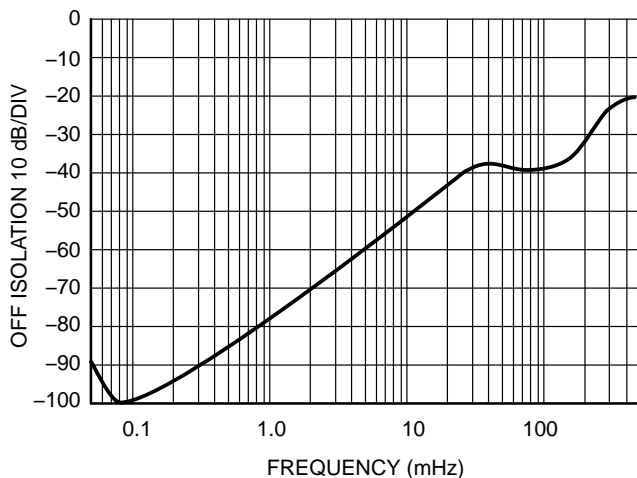

Figure 12. Off Isolation

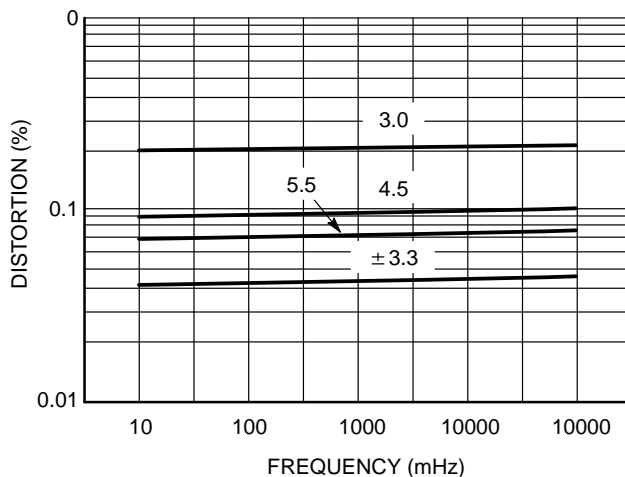

Figure 13. Total Harmonic Distortion

TYPICAL CHARACTERISTICS

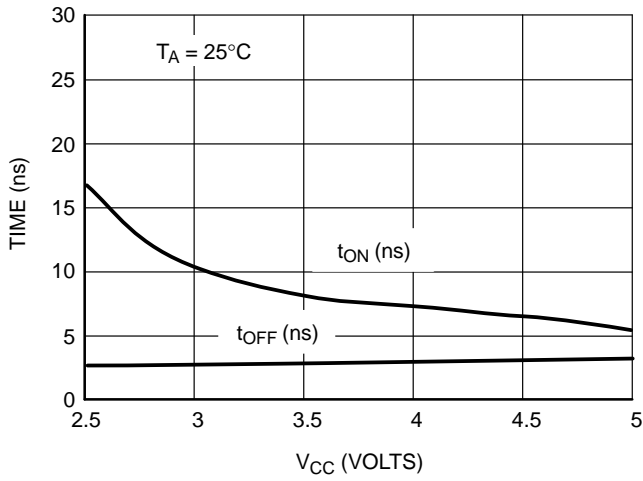

Figure 14. t_{ON} and t_{OFF} versus V_{CC}

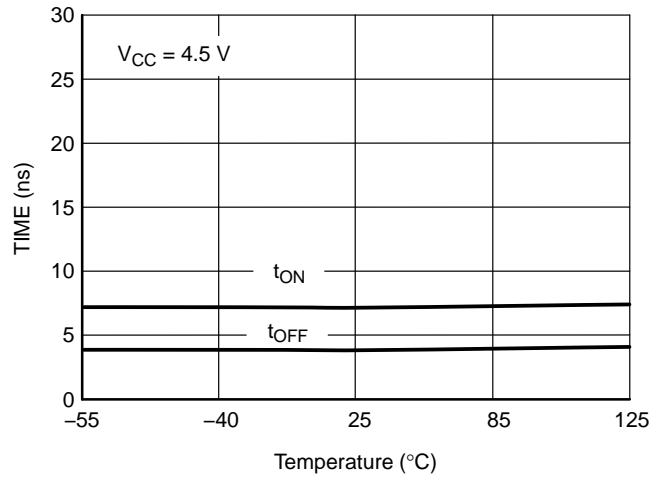

Figure 15. t_{ON} and t_{OFF} versus Temp

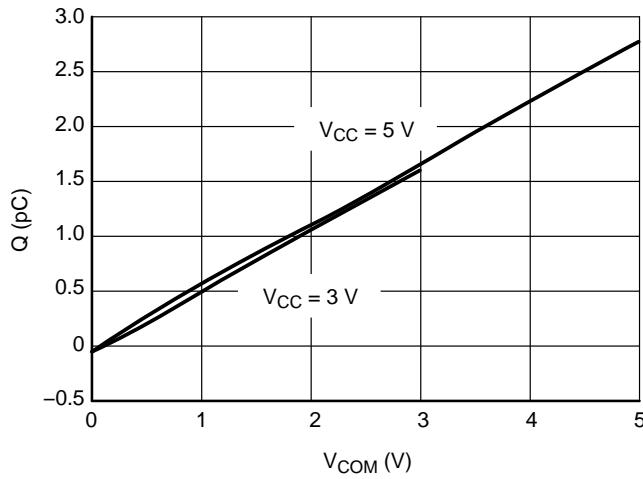

Figure 16. Charge Injection versus COM Voltage

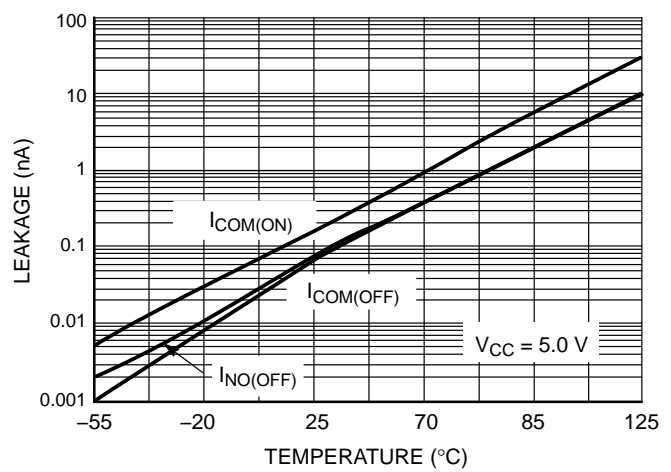

Figure 17. Switch Leakage versus Temperature

NLAST4051

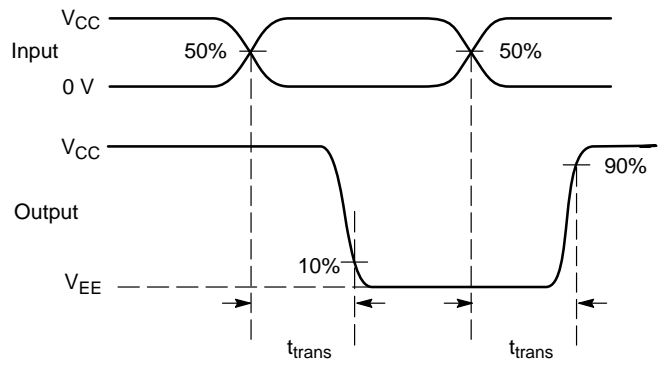
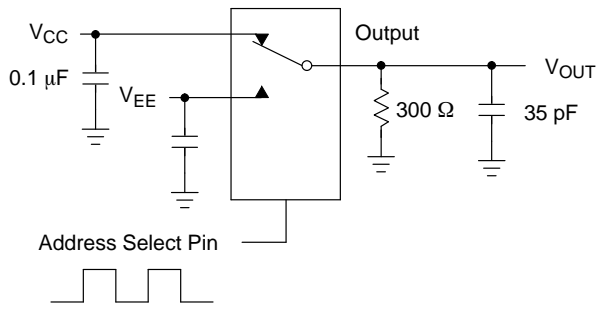

Figure 18. Channel Selection Propagation Delay

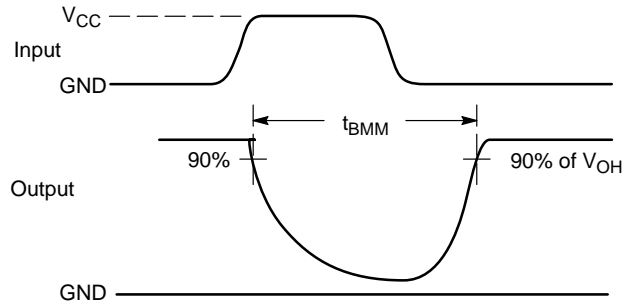
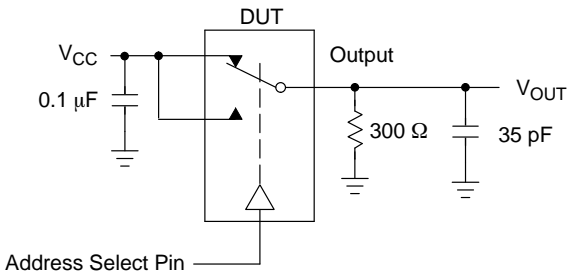

Figure 19. t_{BMM} (Time Break-Before-Make)

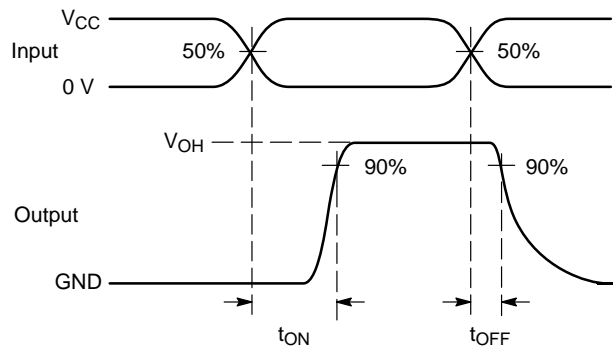
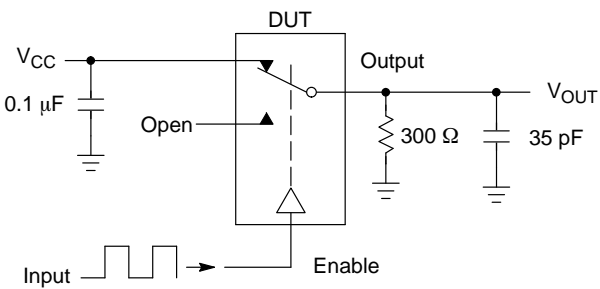

Figure 20. $t_{\text{ON}}/t_{\text{OFF}}$

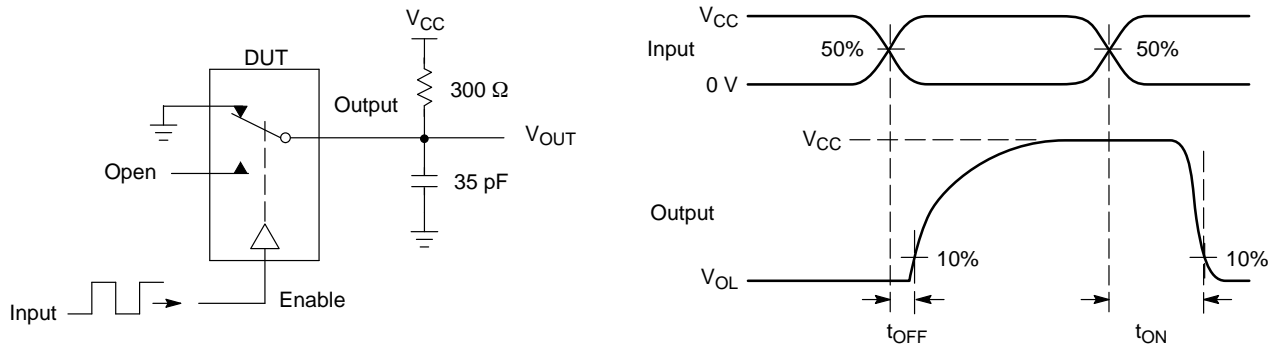
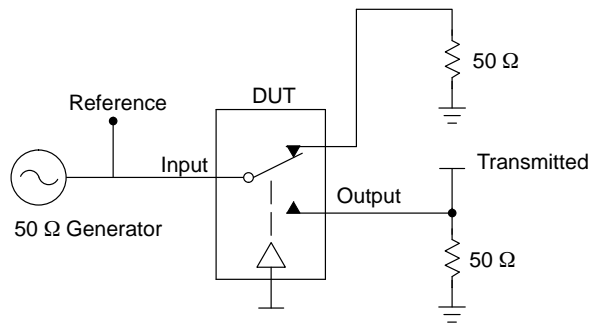

Figure 21. t_{ON}/t_{OFF}



Channel switch Address and Inhibit/s test socket is normalized. Off isolation is measured across an off channel. On loss is the bandwidth of an On switch. V_{ISO} , Bandwidth and V_{ONL} are independent of the input signal direction.

$$V_{ISO} = \text{Off Channel Isolation} = 20 \text{ Log} \left(\frac{V_{OUT}}{V_{IN}} \right) \text{ for } V_{IN} \text{ at } 100 \text{ kHz}$$

$$V_{ONL} = \text{On Channel Loss} = 20 \text{ Log} \left(\frac{V_{OUT}}{V_{IN}} \right) \text{ for } V_{IN} \text{ at } 100 \text{ kHz to } 50 \text{ MHz}$$

Bandwidth (BW) = the frequency 3 dB below V_{ONL}

Figure 22. Off Channel Isolation/On Channel Loss (BW)/Crosstalk (On Channel to Off Channel)/ V_{ONL}

NLAST4051

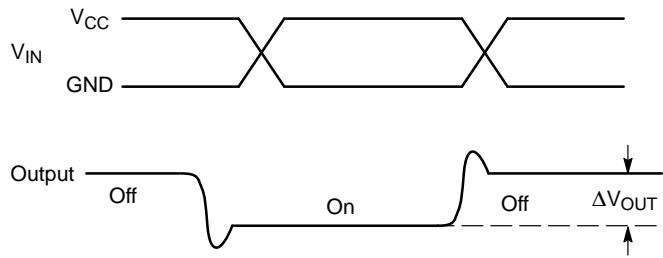
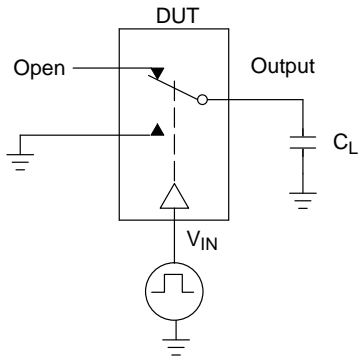

Figure 23. Charge Injection: (Q)

TYPICAL OPERATION

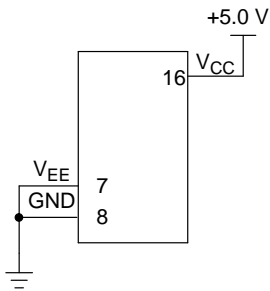

Figure 24. 5.0 Volts Single Supply
 $V_{CC} = 5.0\text{ V}$, $V_{EE} = 0$

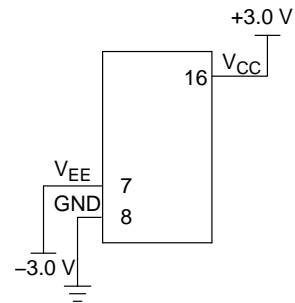

Figure 25. Dual Supply
 $V_{CC} = 3.0\text{ V}$, $V_{EE} = -3.0\text{ V}$

ORDERING INFORMATION

Device	Package	Shipping†
NLAST4051DTR2G	TSSOP-16 (Pb-Free)	2500 / Tape & Reel
NLVAST4051DTR2G*	TSSOP-16 (Pb-Free)	2500 / Tape & Reel

†For information on tape and reel specifications, including part orientation and tape sizes, please refer to our Tape and Reel Packaging Specifications Brochure, BRD8011/D.

*NLV Prefix for Automotive and Other Applications Requiring Unique Site and Control Change Requirements; AEC-Q100 Qualified and PPAP Capable.

NLAST4051

PACKAGE DIMENSIONS

TSSOP-16
DT SUFFIX
CASE 948F
ISSUE B

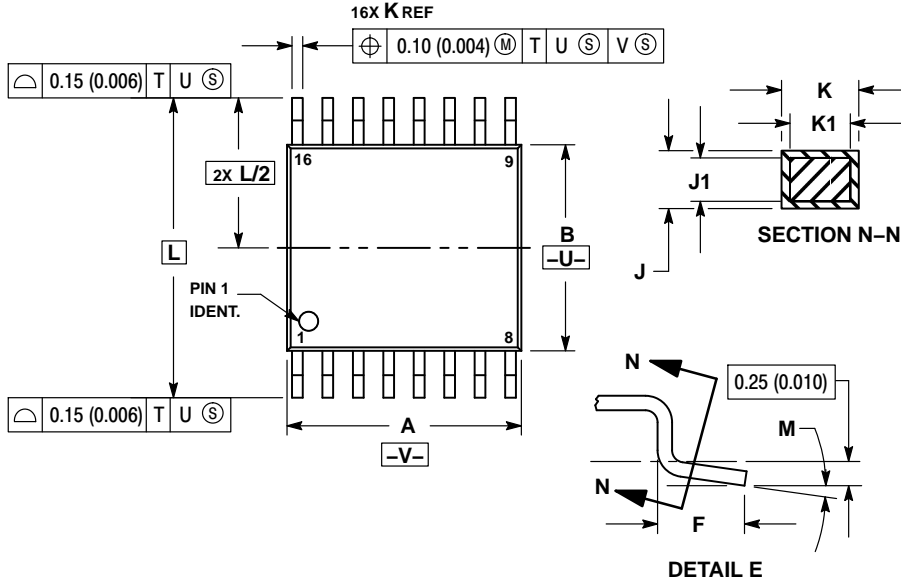

NOTES:

1. DIMENSIONING AND TOLERANCING PER ANSI Y14.5M, 1982.
2. CONTROLLING DIMENSION: MILLIMETER.
3. DIMENSION A DOES NOT INCLUDE MOLD FLASH. PROTRUSIONS OR GATE BURRS. MOLD FLASH OR GATE BURRS SHALL NOT EXCEED 0.15 (0.006) PER SIDE.
4. DIMENSION B DOES NOT INCLUDE INTERLEAD FLASH OR PROTRUSION. INTERLEAD FLASH OR PROTRUSION SHALL NOT EXCEED 0.25 (0.010) PER SIDE.
5. DIMENSION K DOES NOT INCLUDE DAMBAR PROTRUSION. ALLOWABLE DAMBAR PROTRUSION SHALL BE 0.08 (0.003) TOTAL IN EXCESS OF THE K DIMENSION AT MAXIMUM MATERIAL CONDITION.
6. TERMINAL NUMBERS ARE SHOWN FOR REFERENCE ONLY.
7. DIMENSION A AND B ARE TO BE DETERMINED AT DATUM PLANE -W-.

DIM	MILLIMETERS		INCHES	
	MIN	MAX	MIN	MAX
A	4.90	5.10	0.193	0.200
B	4.30	4.50	0.169	0.177
C	---	1.20	---	0.047
D	0.05	0.15	0.002	0.006
F	0.50	0.75	0.020	0.030
G	0.65 BSC		0.026 BSC	
H	0.18	0.28	0.007	0.011
J	0.09	0.20	0.004	0.008
J1	0.09	0.16	0.004	0.006
K	0.19	0.30	0.007	0.012
K1	0.19	0.25	0.007	0.010
L	6.40 BSC		0.252 BSC	
M	0°	8°	0°	8°

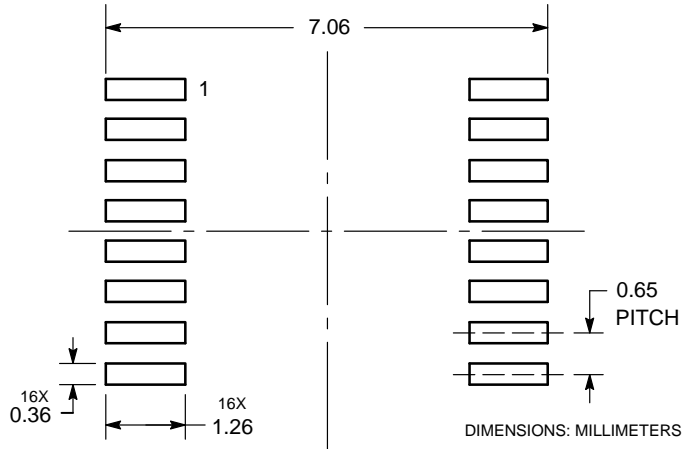
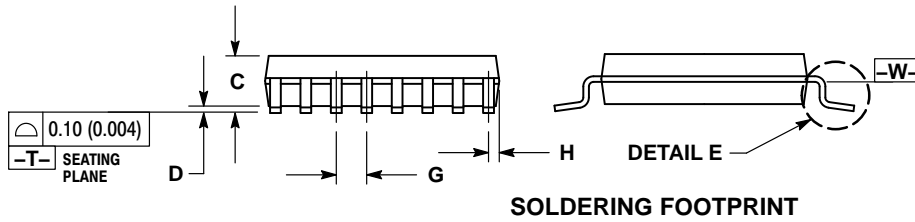

ON Semiconductor and the  are registered trademarks of Semiconductor Components Industries, LLC (SCILLC) or its subsidiaries in the United States and/or other countries. SCILLC owns the rights to a number of patents, trademarks, copyrights, trade secrets, and other intellectual property. A listing of SCILLC's product/patent coverage may be accessed at www.onsemi.com/site/pdf/Patent-Marking.pdf. SCILLC reserves the right to make changes without further notice to any products herein. SCILLC makes no warranty, representation or guarantee regarding the suitability of its products for any particular purpose, nor does SCILLC assume any liability arising out of the application or use of any product or circuit, and specifically disclaims any and all liability, including without limitation special, consequential or incidental damages. "Typical" parameters which may be provided in SCILLC data sheets and/or specifications can and do vary in different applications and actual performance may vary over time. All operating parameters, including "Typicals" must be validated for each customer application by customer's technical experts. SCILLC does not convey any license under its patent rights nor the rights of others. SCILLC products are not designed, intended, or authorized for use as components in systems intended for surgical implant into the body, or other applications intended to support or sustain life, or for any other application in which the failure of the SCILLC product could create a situation where personal injury or death may occur. Should Buyer purchase or use SCILLC products for any such unintended or unauthorized application, Buyer shall indemnify and hold SCILLC and its officers, employees, subsidiaries, affiliates, and distributors harmless against all claims, costs, damages, and expenses, and reasonable attorney fees arising out of, directly or indirectly, any claim of personal injury or death associated with such unintended or unauthorized use, even if such claim alleges that SCILLC was negligent regarding the design or manufacture of the part. SCILLC is an Equal Opportunity/Affirmative Action Employer. This literature is subject to all applicable copyright laws and is not for resale in any manner.

PUBLICATION ORDERING INFORMATION

LITERATURE FULFILLMENT:

Literature Distribution Center for ON Semiconductor
19521 E. 32nd Pkwy, Aurora, Colorado 80011 USA
Phone: 303-675-2175 or 800-344-3860 Toll Free USA/Canada
Fax: 303-675-2176 or 800-344-3867 Toll Free USA/Canada
Email: orderlit@onsemi.com

N. American Technical Support: 800-282-9855 Toll Free
USA/Canada
Europe, Middle East and Africa Technical Support:
Phone: 421 33 790 2910
Japan Customer Focus Center
Phone: 81-3-5817-1050

ON Semiconductor Website: www.onsemi.com
Order Literature: <http://www.onsemi.com/orderlit>
For additional information, please contact your local
Sales Representative