

CGD15SG00D2

Gate Driver for Cree's Generation 3 (C3M™) SiC MOSFET



Application Note

CPWR-AN21, Rev. B

Cree Power Applications

This document is prepared as an application note to install and operate Cree gate driver hardware.

All parts of this application note are provided in English, and the Cautions are provided in English, Mandarin, and Japanese. If the end user of this board is not fluent in any of these languages, it is your responsibility to ensure that they understand the terms and conditions described in this document, including without limitation the hazards of and safe operating conditions for this board.

本文件中的所有內容均以英文書寫，“注意”部分的內容以英文、中文和日語書寫。若本板子的終端用戶不熟悉上述任何一種語言，則您應當確保該終端客戶能夠理解本文件中的條款與條件，包括且不限於本板子的危險以及安全操作條件。

当書類のすべての内容は英語で書きます。「注意点」の内容は英語、中国語、また日本語で書きます。当ボードの端末使用者は上記の言語が一つでもわからないなら、当端末使用者は当書類の条約と条件が理解できるのを確保すべきです。そして、当ボードの危険や安全に使用する条件を含み、また限りません。

Note: This Cree-designed gate driver hardware for Cree components is meant to be used as an evaluation tool in a lab setting and to be handled and operated by highly qualified technicians or engineers. The hardware is not designed to meet any particular safety standards and the tool is not a production qualified assembly.

CAUTION

PLEASE CAREFULLY REVIEW THE FOLLOWING PAGE, AS IT CONTAINS IMPORTANT INFORMATION REGARDING THE HAZARDS AND SAFE OPERATING REQUIREMENTS RELATED TO THE HANDLING AND USE OF THIS BOARD.

警告

请认真阅读以下内容，因为其中包含了处理和使用本板子有关的危险和安全操作要求方面的重要信息。

警告

ボードの使用、危険の対応、そして安全に操作する要求などの大切な情報を含むので、以下の内容をよく読んでください。



CAUTION

DO NOT TOUCH THE BOARD WHEN IT IS ENERGIZED AND ALLOW THE BULK CAPACITORS TO COMPLETELY DISCHARGE PRIOR TO HANDLING THE BOARD. THERE CAN BE VERY HIGH VOLTAGES PRESENT ON THIS EVALUATION BOARD WHEN CONNECTED TO AN ELECTRICAL SOURCE, AND SOME COMPONENTS ON THIS BOARD CAN REACH TEMPERATURES ABOVE 50° CELSIUS. FURTHER, THESE CONDITIONS WILL CONTINUE FOR A SHORT TIME AFTER THE ELECTRICAL SOURCE IS DISCONNECTED UNTIL THE BULK CAPACITORS ARE FULLY DISCHARGED.

Please ensure that appropriate safety procedures are followed when operating this board, as any of the following can occur if you handle or use this board without following proper safety precautions:

- **Death**
- **Serious injury**
- **Electrocution**
- **Electrical shock**
- **Electrical burns**
- **Severe heat burns**

You must read this document in its entirety before operating this board. It is not necessary for you to touch the board while it is energized. All test and measurement probes or attachments must be attached before the board is energized. You must never leave this board unattended or handle it when energized, and you must always ensure that all bulk capacitors have completely discharged prior to handling the board. Do not change the devices to be tested until the board is disconnected from the electrical source and the bulk capacitors have fully discharged.

警告

请勿在通电情况下接触板子，在处理板子前应使大容量电容器完全释放电力。接通电源后，该评估板上可能存在非常高的电压，板子上一些组件的温度可能超过 50 摄氏度。此外，移除电源后，上述情况可能会短暂持续，直至大容量电容器完全释放电量。

操作板子时应确保遵守正确的安全规程，否则可能会出现下列危险：

- 死亡
- 严重伤害
- 触电
- 电击
- 电灼伤
- 严重的热烧伤

请在操作本板子前完整阅读本文件。通电时不必接触板子。在为板子通电前必须连接所有测试与测量探针或附件。通电时，禁止使板子处于无人看护状态，或操作板子。必须确保在操作板子前，大容量电容器释放了所有电量。只有在切断板子电源，且大容量电容器完全放电后，才可更换待测试器件

警告

通電している時、ボードに接触するのは禁止です。ボードを処分する前に、大容量のコンデンサーで電力を完全に解放すべきです。通電してから、ボードにひどく高い電圧が存在している可能性があります。ボードのモジュールの温度は 50 度以上になるかもしれません。また、電源を切った後、上記の状況がしばらく持続する可能性がありますので、大容量のコンデンサーで電力を完全に解放するまで待ってください。

ボードを操作するとき、正確な安全ルールを守るのを確保すべきです。さもないと、以下の危険がある可能性があります：

- 死亡
- 重症
- 感電
- 電撃
- 電気の火傷
- 厳しい火傷

当ボードを操作する前に、完全に当書類をよく読んでください。通電している時にボードに接触する必要がありません。通電する前に必ずすべての試験用のプローブあるいはアクセサリーをつないでください。通電している時に無人監視やボードを操作するのは禁止です。ボードを操作する前に、大容量のコンデンサーで電力を完全に解放するのを必ず確保してください。ボードの電源を切った後、また大容量のコンデンサーで電力を完全に解放した後、試験設備を取り換えることができます。

Table of Contents

1. Introduction	6
2. Comparison of Cree’s CRD-001 and CGD15SG00D2 gate driver boards	6
3. Block diagram of Cree’s CGD15SG00D2 gate driver board	7
4. Physical dimensions of Cree’s CGD15SG00D2 gate driver board	9
5. Connection points of Cree’s CGD15SG00D2 gate driver board	10
6. Schematic drawing of Cree’s CGD15SG00D2 gate driver board	13
7. Bill of materials of Cree’s CGD15SG00D2 gate driver board	13
8. PCB layout of Cree’s CGD15SG00D2 gate drive board	14
9. Revision history	15
Appendix	16

1. Introduction

The purpose of this application note is to demonstrate the design of an isolated gate driver (Cree Part Number: CGD15SG00D2) tailored for Cree’s 3rd Generation (C3M™) Silicon Carbide (SiC) Metal Oxide Semiconductor Field-Effect Transistor (MOSFET). This design includes following features:

- Creepage enhancing groove between the logic side and the power side of the printed circuit board (PCB)
- 2W isolated power supply that enables the operation of larger MOSFETs at higher frequencies
- 5000VAC isolation rated optocoupler
- Separate gate turn-on and gate turn-off resistors with a dedicated diode which allow user friendly optimization of both turn-on and turn-off signals
- Common mode inductor on logic power input for enhanced electro-magnetic interference (EMI) immunity
- 9mm creepage enhancing slot between primary and secondary circuits

The top and bottom views of Cree’s CGD15SG00D2 gate driver board for generation 3 SiC MOSFETs are shown in Figure 1 and Figure 2. The creepage enhancing groove can be seen on both figures. The turn-on and turn-off resistors and the accompanying diode are all on the top side of the board to facilitate changes on the laboratory bench.

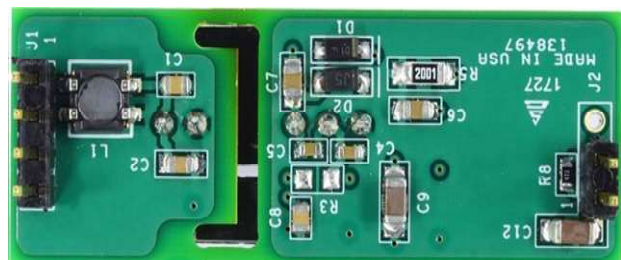
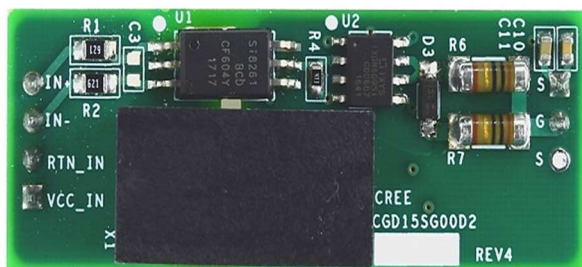

Figure 1: Cree’s CGD15SG00D2 gate driver board (Top) Figure 2: Cree’s CGD15SG00D2 gate driver board (Bottom)

2. Comparison of Cree’s CRD-001 and CGD15SG00D2 gate driver boards

Since gate to source voltage (VGS) requirements of a Cree generation 3 SiC MOSFET are different from the VGS requirements of a Cree C2M™ or a Cree CMF™ SiC MOSFET, Cree’s CGD15SG00D2

has several features that are different from the previously developed generation of gate driver board (Cree Part Number: CRD-001) (as shown in Figure 3). The comparison of Cree’s CGD15SG00D2 gate driver board with Cree’s CRD-001 gate driver board is shown in Table 1.

CRD-001	CGD15SG00D2
Support C2M™ and CMF™ SiC MOSFET	Support C3M™, C2M™ and CMF™ SiC MOSFET
Less Immune to EMI Noise	More Immune to EMI Noise
Large form factor	Small form factor
High V _{GS} output	Low V _{GS} output
Two isolated power supplies	Single isolated power supply

Table 1: Comparison of Cree’s CRD-001 with Cree’s CGD15SG00D2

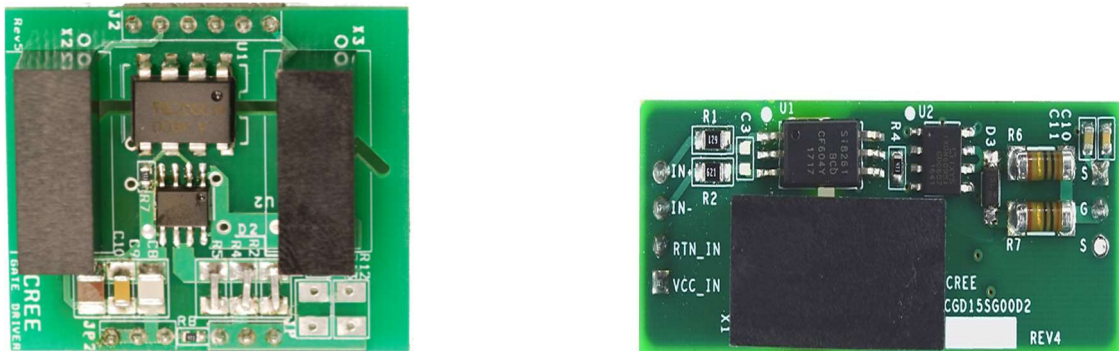

Figure 3. Difference between Cree’s CRD-001 and Cree’s CGD15SG00D2 gate driver boards

3. Block diagram of Cree’s CGD15SG00D2 gate driver board

The block diagram of Cree’s CGD15SG00D2 gate driver board for Cree’s generation 3 SiC MOSFET is illustrated in Figure 4. It consists of an opto-coupler (U1), a gate driver integrated circuit (U2) and an isolated power supply (X1). The opto-coupler (U1) from Silicon Laboratories Inc. (P/N: Si826BCD) gets an input of pulse width modulation (PWM) signals and provides a high common mode immunity (35KV/us minimum, 50 KV/us Typical). A filtering capacitor across the optocoupler input has been provided.

Signal from the output of opto-coupler goes into an IXYS Corporation driver integrated circuit (IC) (U2) (P/N: IXDN609SI) as shown in Figure 4. U2 provides 35V of output swing and up to 9A of output current with a typical output resistance of 0.8 Ω .

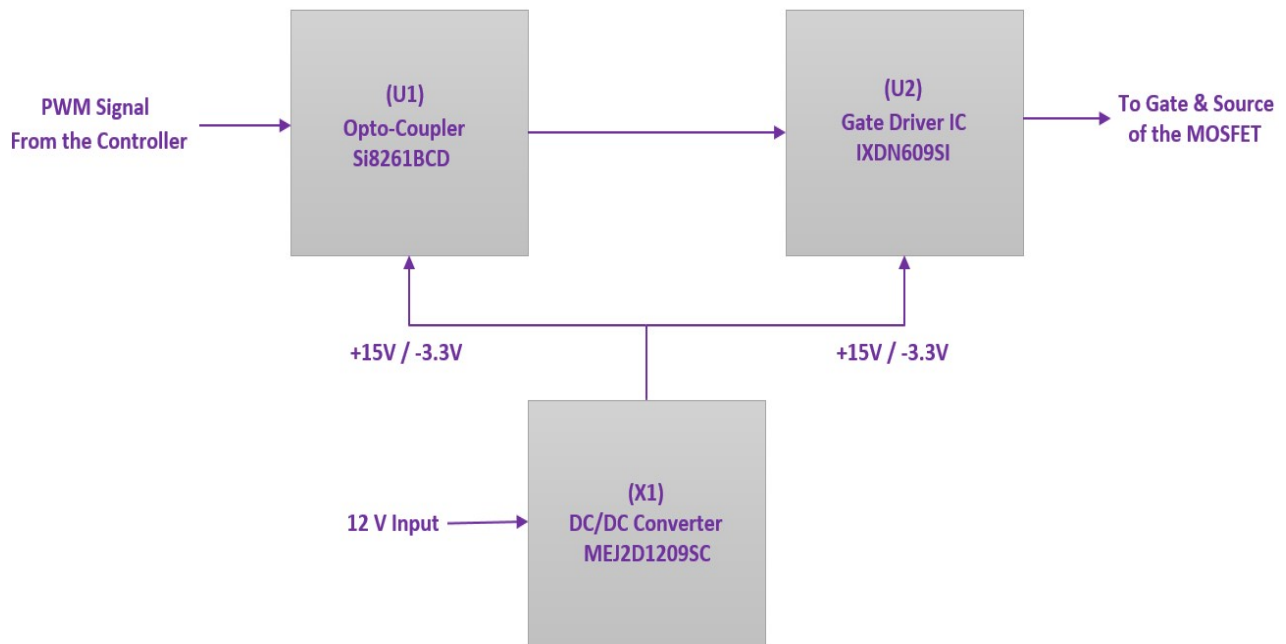

Figure 4. Block diagram of Cree's CGD15SG00D2 gate driver board for Cree's generation 3 SiC MOSFET

Both U1 and U2 gets biasing voltage from an isolated DC/DC (P/N: MEJ2D1209SC) converter (X1) manufactured by Murata Manufacturing Co. Ltd. X1 has an isolation voltage rating of 5.2KV with a very low isolation capacitance of 4pF.

In Cree's CGD15SG00D2 gate driver board, X1 gets 12V input and with the help of a Zener diode (as shown in Figure 7) at the output, X1 gives a dual output of +15 V (turn-on signal) and -3.3 V (turn-off signal). Gate resistors R6 and R7 and a diode D3 (as shown in Figure 7) have been provided for gate turn-on and gate turn-off signals. These gate resistors R6 and R7 are metal electrode leadless face (MELF) 207 packages with a power rating of 0.4W.

In order to minimize stray inductance and to achieve tight coupling, capacitors C10-C12 (as shown in Figure 7) have been placed very close to the source output pin. Specified operating conditions for Cree’s CGD15SG00D2 gate driver board are shown in Table 2.

Operating Conditions					
Symbol	Parameter	Min	Typical	Max	Unit
V _s	Power Supply Voltage	11	12	12.5	V
V _{IH}	Input threshold voltage HIGH	10		15	V
V _{IL}	Input threshold voltage LOW	0		1	V
I _{o_pk}	Output peak current			±9*	A
P _{O_AVG}	Output power per gate	1			W
V _{isol}	Input to output isolation voltage		±1700		V
dv/dt	Rate of change of output to input voltage		50,000		V/μs
W	Weight		9		g
MTBF	Operating temperature		-35 to 85		°C
Top	Storage temperature		-40 to 85		°C

Table 2: Specified operating conditions of Cree’s CGD15SG00D2 gate driver board

*(Actual peak output current will be limited by gate resistor (default is 10ohms turn-on, 5ohms turn-off))

4. Physical dimensions of Cree’s CGD15SG00D2 gate driver board

Physical dimensions of Cree’s CGD15SG00D2 gate driver board when fully assembled are 47.6 X 17.8 X 22.8 mm (as shown in Figure 5).

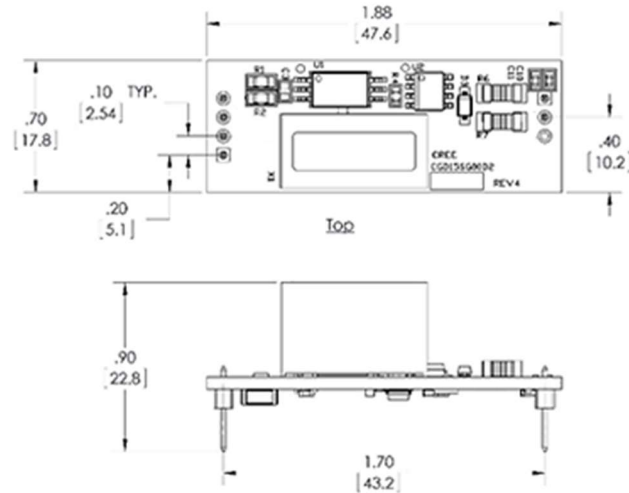

Figure 5. Physical Dimensions of Cree's CGD15SG00D2 gate driver board
(Units are in Inches) *

5. Connection points of Cree's CGD15SG00D2 gate driver board



CAUTION

HIGH VOLTAGE RISK

THERE CAN BE VERY HIGH VOLTAGES PRESENT ON THIS BOARD WHEN CONNECTED TO AN ELECTRICAL SOURCE, AND SOME COMPONENTS ON THIS BOARD CAN REACH TEMPERATURES ABOVE 50° CELSIUS. FURTHER, THESE CONDITIONS WILL CONTINUE AFTER THE ELECTRICAL SOURCE IS DISCONNECTED UNTIL THE BULK CAPACITORS ARE FULLY DISCHARGED. DO NOT TOUCH THE BOARD WHEN IT IS ENERGIZED AND ALLOW THE BULK CAPACITORS TO COMPLETELY DISCHARGE PRIOR TO HANDLING THE BOARD.

The connectors on the board have very high voltage levels present when the board is connected to an electrical source, and thereafter until the bulk capacitors are fully discharged. Please ensure that appropriate safety procedures are followed when working with these connectors as serious injury, including death by electrocution or serious injury by electrical shock or electrical burns, can occur if you do not follow proper safety precautions. When devices are being attached for testing, the board must be disconnected from the electrical source and all bulk

capacitors must be fully discharged. After use the board should immediately be disconnected from the electrical source. After disconnection any stored up charge in the bulk capacitors will continue to charge the connectors. Therefore, you must always ensure that all bulk capacitors have completely discharged prior to handling the board.

警告

高压危险

接通电源后，该评估板上可能存在非常高的电压，板子上一些组件的温度可能超过 50 摄氏度。此外，移除电源后，上述情况可能会短暂持续，直至大容量电容器完全释放电量。通电时禁止触摸板子，应在大容量电容器完全释放电量后，再触摸板子。

板子上的连接器在充电时以及充电后都具有非常高的电压，直至大容量电容器完全释放电量。请确保在操作板子时已经遵守了正确的安全流程，否则可能会造成严重伤害，包括触电死亡、电击伤害或电灼伤。连接器件进行测试时，必须切断板子电源，且大容量电容器必须释放了所有电量。使用后应立即切断板子电源。切断电源后，大容量电容器中存储的电量会继续输入至连接器中。因此，必须始终在操作板子前，确保大容量电容器已完全释放电量。

警告

高压危险

通電してから、ボードにひどく高い電圧が存在している可能性があります。ボードのモジュールの温度は50度以上になるかもしれません。また、電源を切った後、上記の状況がしばらく持続する可能性がありますので、大容量のコンデンサーで電力を完全に釈放するまで待ってください。通電している時にボードに接触するのは禁止で

す。大容量のコンデンサーで電力をまだ完全に釈放していない時、ボードに接触しないでください。

ボードのコネクターは充電中また充電した後、ひどく高い電圧が存在しているので、大容量のコンデンサーで電力を完全に釈放するまで待ってください。ボードを操作している時、正確な安全ルールを守っているのを確保してください。さもないと、感電、電撃、厳しい火傷などの死傷が出る可能性があります。設備をつないで試験する時、必ずボードの電源を切

ってください。また、大容量のコンデンサーで電力を完全に釈放してください。使用後、すぐにボードの電源を切ってください。電源を切った後、大容量のコンデンサーに貯蓄している電量はコネクタに持続的に入るので、ボードを操作する前に、必ず大容量のコンデンサーの電力を完全に釈放するのを確保してください。

Connection points of Cree’s CGD15SG00D2 gate driver board are in the form of two jumpers, J1 and J2 (as shown in Figure 6). Jumper J1 has connection points IN+, IN-, RTN_IN and VCC_IN. IN+ and IN- can be used for the input of PWM signals while RTN_IN and VCC_IN can be used for the input of a DC/DC Converter. Jumper J2 has connection points of gate and source that can be used to connect Cree’s generation 3 SiC MOSFET.

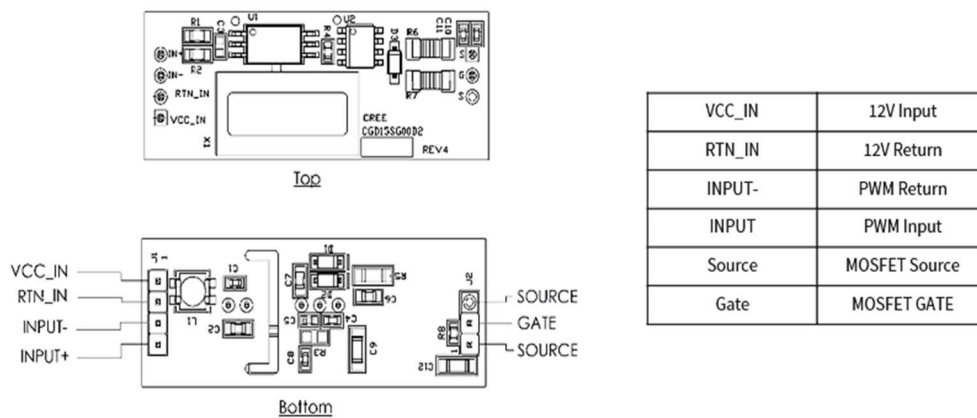

Figure 6: Connection Points of Cree’s CGD15SG00D2 gate driver board

8. PCB layout of Cree's CGD15SG00D2 gate driver board

Good PCB layout practice is essential to drive Cree's generation 3 SiC MOSFET. Minimizing stray inductance in the gate and source path helps reducing ringing and voltage drops that occur due to $L \cdot di/dt$. Figure 8 shows the top copper layer of Cree's CGD15SG00D2 gate driver board with the gate driver IC (U2), gate drive resistors (R6&R7) and diode (D3). Figure 9 shows the inner copper layer 1 of Cree's CGD15SG00D2 gate driver board. On that layer, users can observe that the source connection to gate driver IC (U2) is in the form of a large plane encompassing all of the gate driver output components (i.e. the gate resistors, and diode) that sit on the top layer of the PCB. This ensures that the current from the gate driver IC output goes through the gate drive resistors and is ultimately mirrored on inner layer 1 of the PCB to minimize inductance.

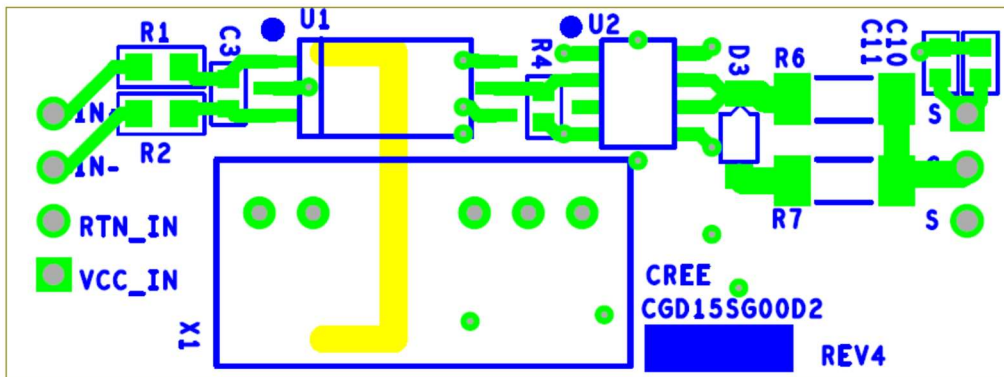

Figure 8: Top Layer Copper of Cree's CGD15SG00D2 gate driver board

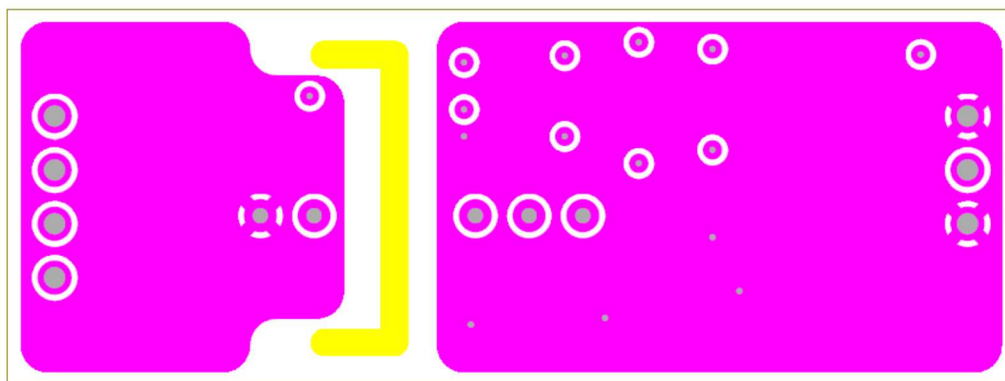

Figure 9: Inner Layer 1 Copper of Cree's CGD15SG00D2 gate driver board

Inner layer 2 (as shown in Figure 10) on the secondary side of the creepage slot, has a large plane carrying the negative drive voltage (-3V). The bottom copper layer (as shown in Figure 11), also on the secondary side of the creepage slot, has a large plane carrying the positive drive voltage (+15V). The VCC input (+12V) has been placed on two large layers which are on the primary side of the creepage slot (inner layer 1 (+VCC) and inner layer 2 (VCC_RTN)).

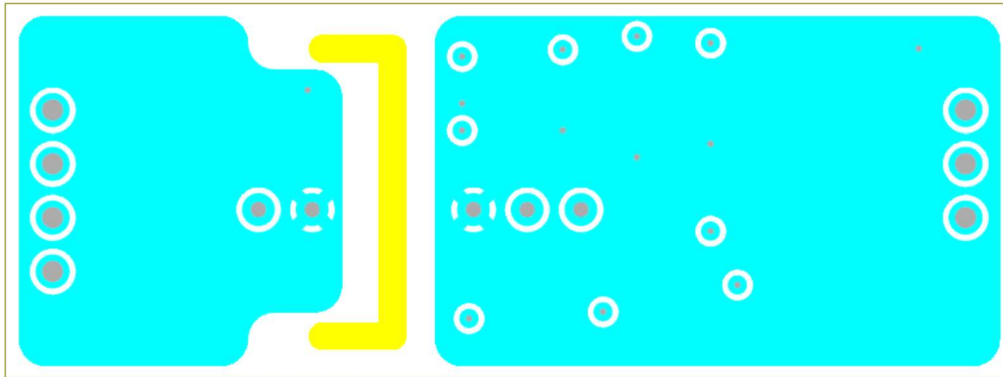

Figure 10: Inner Layer 2 Copper of Cree's CGD15SG00D2 gate driver board

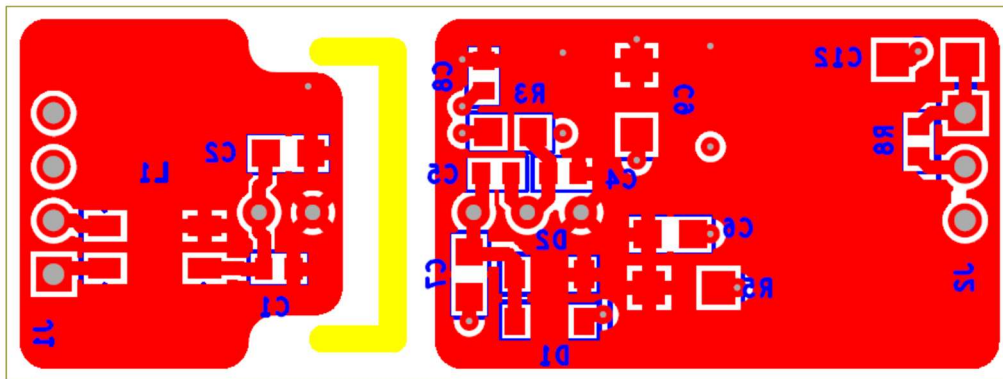

Figure 11: Bottom Layer Copper of Cree's CGD15SG00D2 gate driver board

9. Revision history

Date	Revision	Changes
04/18/2018	Rev B	1 st issue

Appendix

Modification Instructions of Cree's CGD15SG00D2 gate driver board to make it compatible with Cree generation1 and generation2 SiC MOSFETs

Cree C2M™ and CMF™ SiC MOSFETs have different gate drive requirements than Cree's C3M™ SiC MOSFET. For Cree C2M™ and CMF™ SiC MOSFETs, the recommended turn-on voltage is +20V and the recommended turn-off voltage is -5V. With a few modifications, Cree's CGD15SG00D2 gate driver board can be used to drive Cree C2M™ and CMF™ SiC MOSFETs.

These modifications are as follows:

- Biasing input (VCC) (as shown in Figure 7) needs to be set at 15V instead of 12V.
- The main isolated power supply (X1) needs to be replaced with another power supply that accepts 15VDC input and gives +20V and -5V output.
- The 3.3V zener diode (D1) (as shown in Figure 7) that sets the negative bias voltage must be removed.
- The output protection Zener diode (D2, 20V) of isolated power supply (X1) must be replaced by a higher voltage Zener diode (27V) so that it cannot clamp the higher output voltage of the new X1 (25V) during normal operation.
- Resistor R3 (0 ohms) should be populated on the board to connect the common terminal of X1 to the source connection of the driver.
- Resistor R5 is used in Cree's CGD15SG00D2 gate driver board to setup 3.3V negative bias voltage but in Cree's C2M™ and CMF™ SiC MOSFET gate driver board configuration, resistor R5 must be removed (or it may be damaged by the -5V output).

The modifications are summarized below.

Reference	Location	Remove	Populate
X1	Top	MEJ2D1209SC	MGJ2D152005SC (Murata) or RKZ-152005D (Recom)
D1	Bottom	MMSZ5226BT1G	-
D2	Bottom	MMSZ5250B-TP	MMSZ5254B-TP
R3	Bottom	-	0805 0ohm jumper
R5	Bottom	2kohms	-

Table 4: Design Modifications of Cree's CGD15SG00D2 gate driver board

IMPORTANT NOTES

Purposes and Use

Cree, Inc. (on behalf of itself and its affiliates, “Cree”) reserves the right in its sole discretion to make corrections, enhancements, improvements, or other changes to the board or to discontinue the board.

THE BOARD DESCRIBED IS AN ENGINEERING TOOL INTENDED SOLELY FOR LABORATORY USE BY HIGHLY QUALIFIED AND EXPERIENCED ELECTRICAL ENGINEERS TO EVALUATE THE PERFORMANCE OF CREE POWER SWITCHING DEVICES. THE BOARD SHOULD NOT BE USED AS ALL OR PART OF A FINISHED PRODUCT. THIS BOARD IS NOT SUITABLE FOR SALE TO OR USE BY CONSUMERS AND CAN BE HIGHLY DANGEROUS IF NOT USED PROPERLY. THIS BOARD IS NOT DESIGNED OR INTENDED TO BE INCORPORATED INTO ANY OTHER PRODUCT FOR RESALE. THE USER SHOULD CAREFULLY REVIEW THE DOCUMENT TO WHICH THESE NOTIFICATIONS ARE ATTACHED AND OTHER WRITTEN USER DOCUMENTATION THAT MAY BE PROVIDED BY CREE (TOGETHER, THE “DOCUMENTATION”) PRIOR TO USE. USE OF THIS BOARD IS AT THE USER’S SOLE RISK.

Operation of Board

It is important to operate the board within Cree’s recommended specifications and environmental considerations as described in the Documentation. Exceeding specified ratings (such as input and output voltage, current, power, or environmental ranges) may cause property damage. If you have questions about these ratings, please contact Cree at sic_power@cree.com prior to connecting interface electronics (including input power and intended loads). Any loads applied outside of a specified output range may result in adverse consequences, including unintended or inaccurate evaluations or possible permanent damage to the board or its interfaced electronics. Please consult the Documentation prior to connecting any load to the board. If you have any questions about load specifications for the board, please contact Cree at sic_power@cree.com for assistance.

Users should ensure that appropriate safety procedures are followed when working with the board as serious injury, including death by electrocution or serious injury by electrical shock or electrical burns can occur if you do not follow proper safety precautions. It is not necessary in proper operation for the user to touch the board while it is energized. When devices are being

attached to the board for testing, the board must be disconnected from the electrical source and any bulk capacitors must be fully discharged. When the board is connected to an electrical source and for a short time thereafter until board components are fully discharged, some board components will be electrically charged and/or have temperatures greater than 50° Celsius. These components may include bulk capacitors, connectors, linear regulators, switching transistors, heatsinks, resistors and SiC diodes that can be identified using board schematic. Users should contact Cree at sic_power@cree.com for assistance if a board schematic is not included in the Documentation or if users have questions about a board's components. When operating the board, users should be aware that these components will be hot and could electrocute or electrically shock the user. As with all electronic evaluation tools, only qualified personnel knowledgeable in handling electronic performance evaluation, measurement, and diagnostic tools should use the board.

User Responsibility for Safe Handling and Compliance with Laws

Users should read the Documentation and, specifically, the various hazard descriptions and warnings contained in the Documentation, prior to handling the board. The Documentation contains important safety information about voltages and temperatures.

Users assume all responsibility and liability for the proper and safe handling of the board. Users are responsible for complying with all safety laws, rules, and regulations related to the use of the board. Users are responsible for (1) establishing protections and safeguards to ensure that a user's use of the board will not result in any property damage, injury, or death, even if the board should fail to perform as described, intended, or expected, and (2) ensuring the safety of any activities to be conducted by the user or the user's employees, affiliates, contractors, representatives, agents, or designees in the use of the board. User questions regarding the safe usage of the board should be directed to Cree at sic_power@cree.com.

In addition, users are responsible for:

- compliance with all international, national, state, and local laws, rules, and regulations that apply to the handling or use of the board by a user or the user's employees, affiliates, contractors, representatives, agents, or designees.

- taking necessary measures, at the user's expense, to correct radio interference if operation of the board causes interference with radio communications. The board may generate, use, and/or radiate radio frequency energy, but it has not been tested for compliance within the limits of computing devices pursuant to Federal Communications Commission or Industry Canada rules, which are designed to provide protection against radio frequency interference.
- compliance with applicable regulatory or safety compliance or certification standards that may normally be associated with other products, such as those established by EU Directive 2011/65/EU of the European Parliament and of the Council on 8 June 2011 about the Restriction of Use of Hazardous Substances (or the RoHS 2 Directive) and EU Directive 2002/96/EC on Waste Electrical and Electronic Equipment (or WEEE). The board is not a finished product and therefore may not meet such standards. Users are also responsible for properly disposing of a board's components and materials.

No Warranty

THE BOARD IS PROVIDED "AS IS" WITHOUT WARRANTY OF ANY KIND, INCLUDING BUT NOT LIMITED TO ANY WARRANTY OF NON-INFRINGEMENT, MERCHANTABILITY, OR FITNESS FOR A PARTICULAR PURPOSE, WHETHER EXPRESS OR IMPLIED. THERE IS NO REPRESENTATION THAT OPERATION OF THIS BOARD WILL BE UNINTERRUPTED OR ERROR FREE.

Limitation of Liability

IN NO EVENT SHALL CREE BE LIABLE FOR ANY DAMAGES OF ANY KIND ARISING FROM USE OF THE BOARD. CREE'S AGGREGATE LIABILITY IN DAMAGES OR OTHERWISE SHALL IN NO EVENT EXCEED THE AMOUNT, IF ANY, RECEIVED BY CREE IN EXCHANGE FOR THE BOARD. IN NO EVENT SHALL CREE BE LIABLE FOR INCIDENTAL, CONSEQUENTIAL, OR SPECIAL LOSS OR DAMAGES OF ANY KIND, HOWEVER CAUSED, OR ANY PUNITIVE, EXEMPLARY, OR OTHER DAMAGES. NO ACTION, REGARDLESS OF FORM, ARISING OUT OF OR IN ANY WAY CONNECTED WITH ANY BOARD FURNISHED BY CREE MAY BE BROUGHT AGAINST CREE MORE THAN ONE (1) YEAR AFTER THE CAUSE OF ACTION ACCRUED.

Indemnification

The board is not a standard consumer or commercial product. As a result, any indemnification obligations imposed upon Cree by contract with respect to product safety, product liability, or intellectual property infringement do not apply to the board.