



IR Emitter and Detector Product Data Sheet

LTR-3208

Spec No.: DS-50-92-0067

Effective Date: 04/09/2013

Revision: B

LITE-ON DCC

RELEASE

BNS-OD-FC001/A4



REV.A JAN 2013

FEATURES

- * WIDE RANGE OF COLLECTOR CURRENT
- * THE LENS IS FOR HIGH SENSITIVITY
- * LOW COST PLASTIC PACKAGE

PACKAGE DIMENSIONS

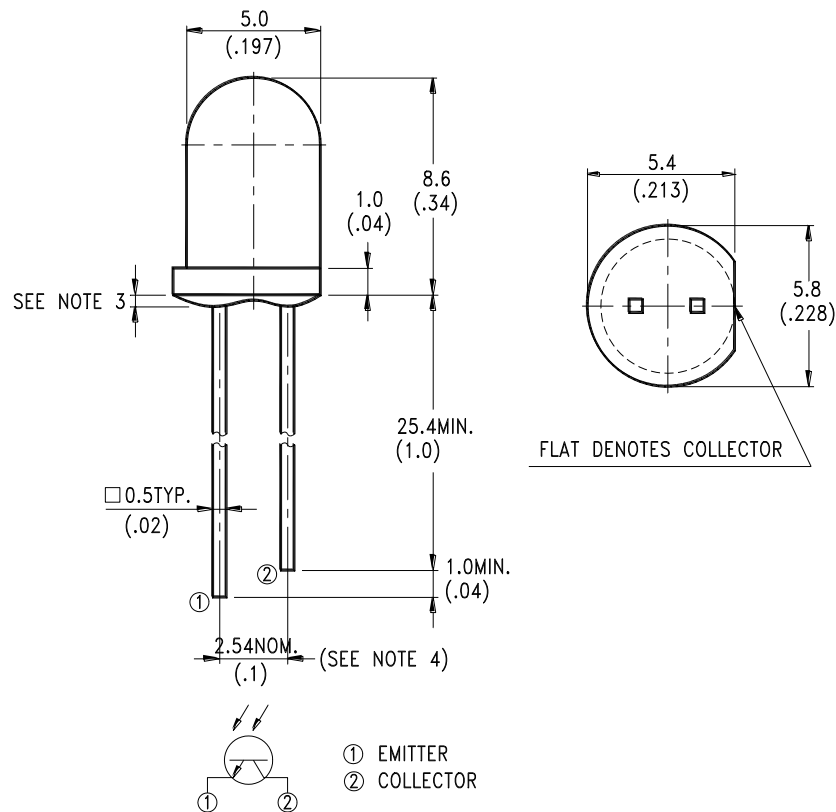

NOTES:

1. All dimensions are in millimeters (inches).
2. Tolerance is $\pm 0.25\text{mm} (.010\text{'})$ unless otherwise noted.
3. Protruded resin under flange is $1.5\text{mm} (.059\text{'})$ max.
4. Lead spacing is measured where the leads emerge from the package.
5. Specifications are subject to change without notice.



LITE-ON ELECTRONICS, INC.

Property of Lite-On Only

ABSOLUTE MAXIMUM RATINGS AT TA=25°C

PARAMETER	MAXIMUM RATING	UNIT
Power Dissipation	100	mW
Collector-Emitter Voltage	30	V
Emitter-Collector Voltage	5	V
Operating Temperature Range	-40°C to + 85°C	
Storage Temperature Range	-55°C to + 100°C	
Lead Soldering Temperature [1.6mm(.063") From Body]	260°C for 5 Seconds	

ELECTRICAL / OPTICAL CHARACTERISTICS AT TA=25°C

PARAMETER	SYMBOL	MIN.	TYP.	MAX.	UNIT	TEST CONDITION	BIN NO.
Collector-Emitter Breakdown Voltage	$V_{(BR)CEO}$	30			V	$I_C = 1mA$ $E_e = 0mW/cm^2$	
Emitter-Collector Breakdown Voltage	$V_{(BR)ECO}$	5			V	$I_E = 100\mu A$ $E_e = 0mW/cm^2$	
Collector Emitter Saturation Voltage	$V_{CE(SAT)}$		0.1	0.4	V	$I_C = 100\mu A$ $E_e = 1mW/cm^2$	
Rise Time	T_r		10		μs	$V_{CC} = 5V$ $I_C = 1mA$ $R_L = 1K\Omega$	
Fall Time	T_f		15		μs		
Collector Dark Current	I_{CEO}			100	nA	$V_{CE} = 10V$ $E_e = 0mW/cm^2$	
On State Collector Current	$I_{C(ON)}$	0.8		2.4	mA	$V_{CE} = 5V$ $E_e = 1mW/cm^2$ $\lambda = 940nm$	BIN C
		1.6		4.8			BIN D
		3.2		9.6			BIN E
		6.4					BIN F

TYPICAL ELECTRICAL / OPTICAL CHARACTERISTICS CURVES

(25°C Ambient Temperature Unless Otherwise Noted)

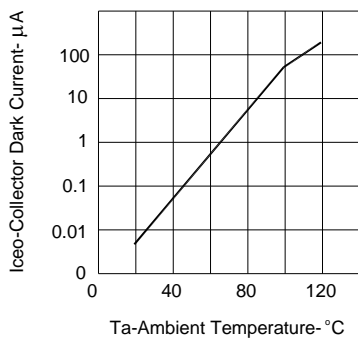

FIG.1 COLLECTOR DARK CURRENT VS AMBIENT TEMPERATURE

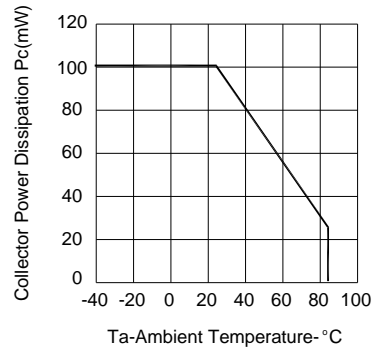

FIG.2 COLLECTOR POWER DISSIPATION VS AMBIENT TEMPERATURE

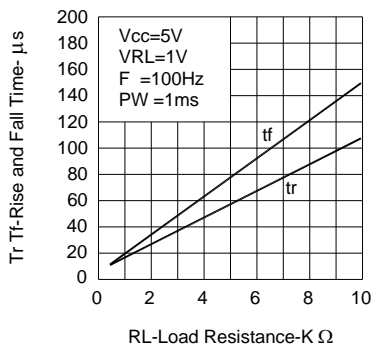

FIG.3 RISE AND FALL TIME VS LOAD RESISTANCE

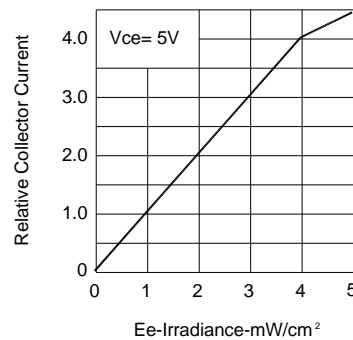

FIG.4 RELATIVE COLLECTOR CURRENT VS IRRADIANCE

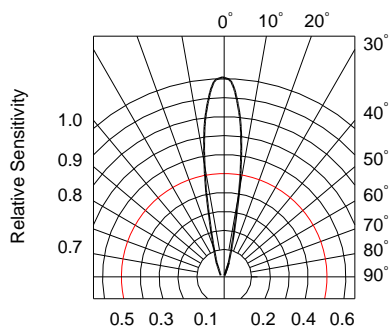

FIG.5 SENSITIVITY DIAGRAM

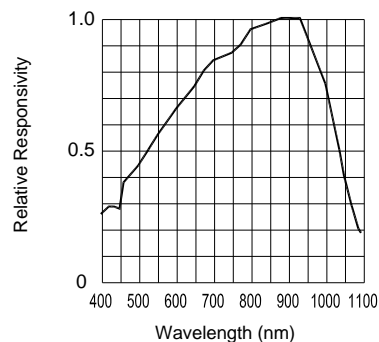

FIG.6 SPECTRAL DISTRIBUTION