

CNC7S101 (ON3181), CNC1H101 (ON3184)

Optoisolators

■ Overview

CNC7S101 is an AC input compatible optoisolator in which two GaAs high output infrared light emitting diode chips are connected in reverse parallel as light emitting elements, and optically are connected to a high sensitivity Si phototransistor chip as a light detecting element in a small DIL 4-pin package.

The CNC7S101, CNC1H101 have a number of excellent features, including high I/O isolation voltage and current transfer ratio (CTR), as well as high speed response and high reliability.

■ Features

- AC input support
- High I/O isolation voltage: $V_{ISO} = 5\,000\text{ V[rms]}$ (min.)
- Fast response: $t_r = 4\ \mu\text{s}$, $t_f = 3\ \mu\text{s}$
- UL listed (UL File No. E79920)

■ Applications

- Telephones
- Telephone switches
- Programmable controllers
- AC/DC input modules for measuring

■ Pin Connection

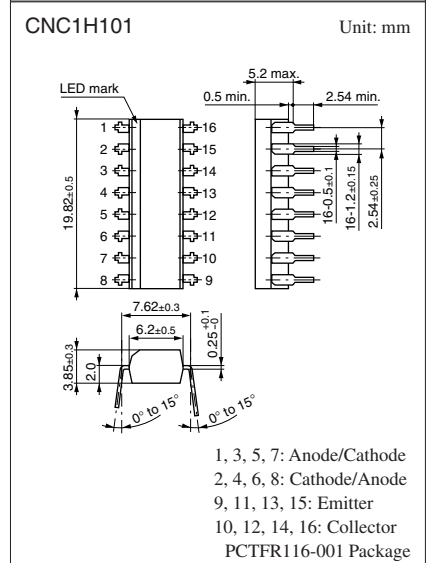
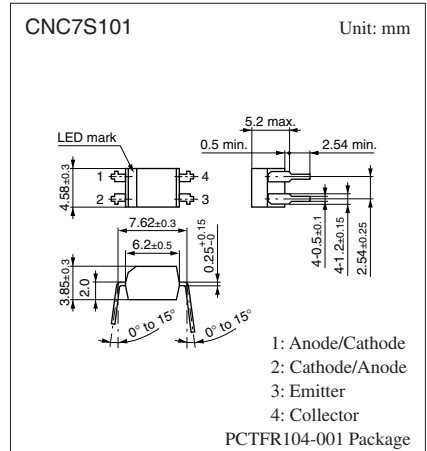
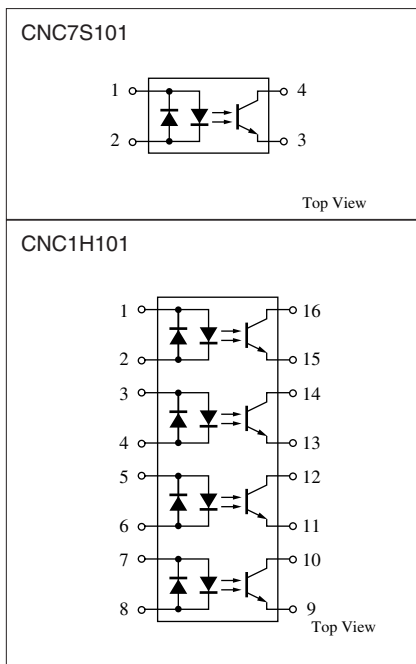

Note) The part numbers in the parenthesis show conventional part number.

■ Absolute Maximum Ratings $T_a = 25^\circ\text{C}$

Parameter		Symbol	Rating	Unit
Input (Light emitting diode)	Forward current	I_F	± 50	mA
	Pulse forward current *1	I_{FP}	± 1	A
	Power dissipation *2	P_D	75	mW
Output (Photo transistor)	Collector-emitter voltage (Base open)	V_{CEO}	80	V
	Emitter-collector voltage (Base open)	V_{ECO}	7	V
	Collector current	I_C	50	mA
	Collector power dissipation *3	P_C	150	mW
Isolation voltage, input to output *4		V_{ISO}	5 000	V[rms]
Total power dissipation		P_T	200	mW
Operating ambient temperature		T_{opr}	-30 to +100	$^\circ\text{C}$
Storage temperature		T_{stg}	-55 to +125	$^\circ\text{C}$

Note) *1: Pulse width $\leq 100 \mu\text{s}$, repeat 100 pps

*2: Input power derating ratio is 0.75 mW/ $^\circ\text{C}$ at $T_a \geq 25^\circ\text{C}$

*3: Output power derating ratio is 1.5 mW/ $^\circ\text{C}$ at $T_a \geq 25^\circ\text{C}$

*4: AC 1 min., RH < 60%

■ Electrical-Optical Characteristics $T_a = 25^\circ\text{C} \pm 3^\circ\text{C}$

Parameter		Symbol	Conditions	Min	Typ	Max	Unit
Input characteristics	Forward voltage	V_F	$I_F = \pm 50 \text{ mA}$		1.35	1.50	V
	Terminal capacitance	CNC7S101	$V_R = 0 \text{ V}, f = 1 \text{ MHz}$		35		pF
		CNC1H101			15		
Output characteristics	Collector-emitter voltage (Base open)	V_{CEO}	$I_C = 100 \mu\text{A}$	80			V
	Emitter-collector voltage (Base open)	V_{ECO}	$I_E = 10 \mu\text{A}$	7			V
	Collector-emitter cutoff current (Base open)	I_{CEO}	$V_{CE} = 20 \text{ V}$		5	100	nA
	Collector-emitter capacitance	C_C	$V_{CE} = 10 \text{ V}, f = 1 \text{ MHz}$		3.0		pF
Transfer characteristics	DC current transfer ratio *1,5	CTR	$V_{CE} = 5 \text{ V}, I_F = \pm 1 \text{ mA}$	20		300	%
	Isolation capacitance, input to output	C_{ISO}	$f = 1 \text{ MHz}$		0.6		pF
	Isolation resistance, input to output	R_{ISO}	$V_{ISO} = 500 \text{ V}$	10^{11}			Ω
	Rise time *2	t_r	$V_{CC} = 10 \text{ V}, I_C = 2 \text{ mA}$		4		μs
	Fall time *3	t_f	$R_L = 100 \Omega$		3		μs
	Collector-emitter saturation voltage	$V_{CE(sat)}$	$I_F = \pm 20 \text{ mA}, I_C = 1 \text{ mA}$		0.1	0.2	V
Collector current ratio *4	$I_{C(Ratio)}$	$V_{CE} = 5 \text{ V}, I_F = 1 \text{ mA}$	0.33	1.00	3.00	—	

Note) 1. Input and output are handled electrically.

2. This product is not designed to withstand radiation

3. *1:
$$CTR = \frac{I_C}{I_F} \times 100\%$$

*2: t_r : Time required for the collector current to increase from 10% to 90% of its final value

*3: t_f : Time required for the collector current to decrease from 90% to 10% of its initial value

*4:
$$I_{C(Ratio)} = \frac{I_{C2} (I_{F2} = 1\text{mA}, V_{CE} = 5\text{V})}{I_{C1} (I_{F1} = 1\text{mA}, V_{CE} = 5\text{V})}$$

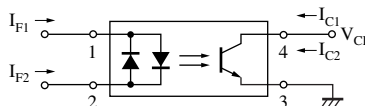

*5: Rank classification

Rank	R	S	No-rank
CTR (%)	50 to 150	100 to 300	20 to 300

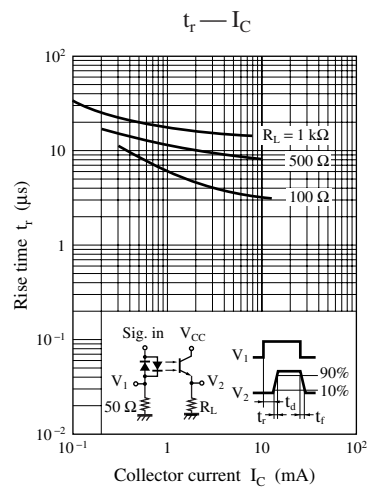
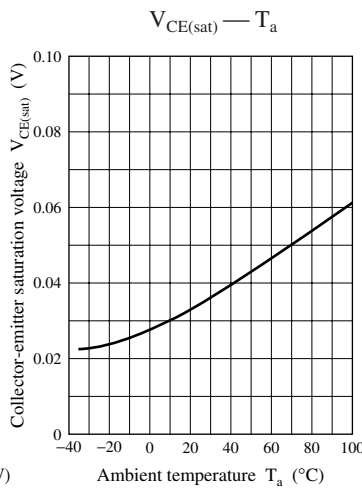
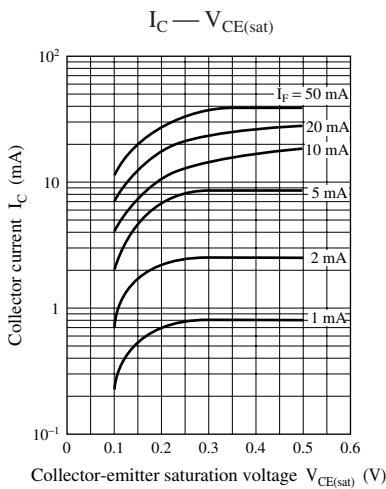
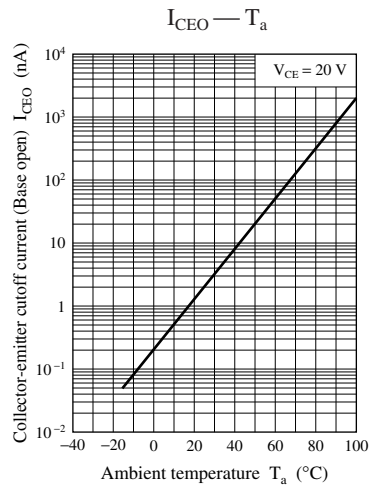
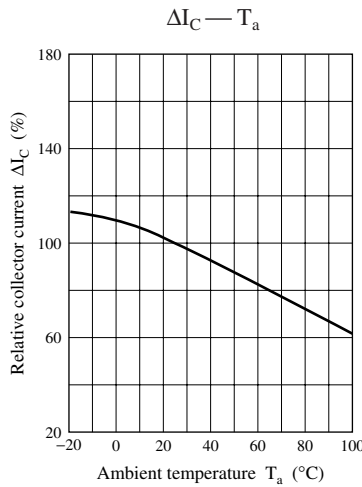
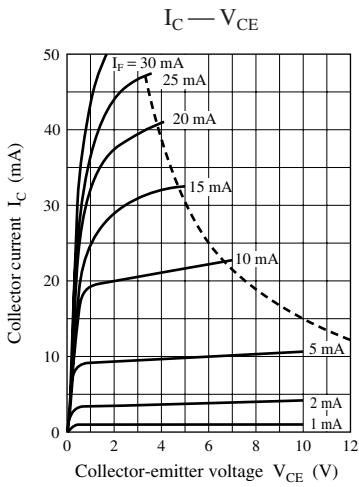
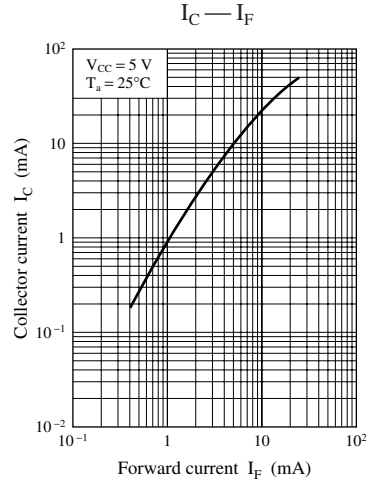
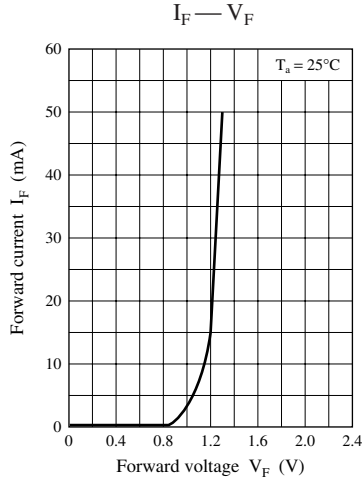
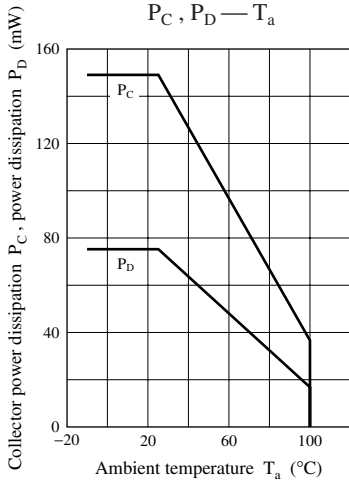

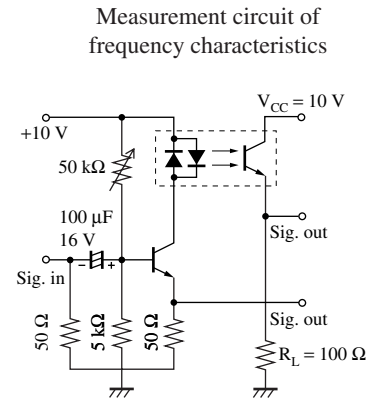
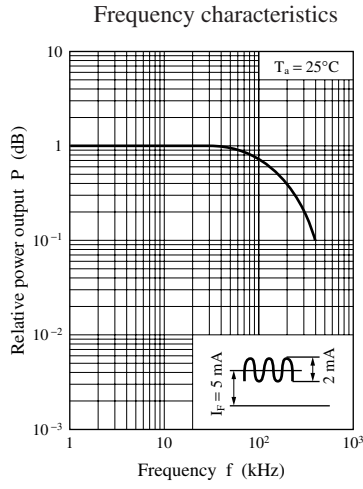
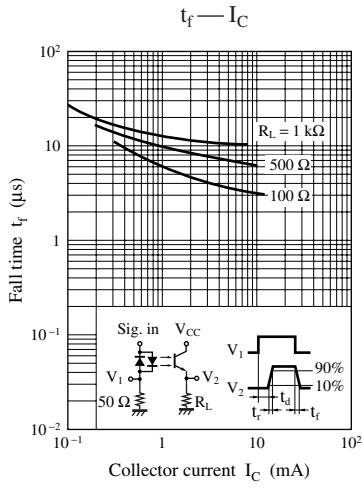

Caution for Safety

 **DANGER**

■ This product contains Gallium Arsenide (GaAs).

GaAs powder and vapor are hazardous to human health if inhaled or ingested. Do not burn, destroy, cut, cleave off, or chemically dissolve the product. Follow related laws and ordinances for disposal. The product should be excluded from general industrial waste or household garbage.

Request for your special attention and precautions in using the technical information and semiconductors described in this material

- (1) An export permit needs to be obtained from the competent authorities of the Japanese Government if any of the products or technical information described in this material and controlled under the "Foreign Exchange and Foreign Trade Law" is to be exported or taken out of Japan.
- (2) The technical information described in this material is limited to showing representative characteristics and applied circuits examples of the products. It neither warrants non-infringement of intellectual property right or any other rights owned by our company or a third party, nor grants any license.
- (3) We are not liable for the infringement of rights owned by a third party arising out of the use of the technical information as described in this material.
- (4) The products described in this material are intended to be used for standard applications or general electronic equipment (such as office equipment, communications equipment, measuring instruments and household appliances).
Consult our sales staff in advance for information on the following applications:
 - Special applications (such as for airplanes, aerospace, automobiles, traffic control equipment, combustion equipment, life support systems and safety devices) in which exceptional quality and reliability are required, or if the failure or malfunction of the products may directly jeopardize life or harm the human body.
 - Any applications other than the standard applications intended.
- (5) The products and product specifications described in this material are subject to change without notice for modification and/or improvement. At the final stage of your design, purchasing, or use of the products, therefore, ask for the most up-to-date Product Standards in advance to make sure that the latest specifications satisfy your requirements.
- (6) When designing your equipment, comply with the guaranteed values, in particular those of maximum rating, the range of operating power supply voltage, and heat radiation characteristics. Otherwise, we will not be liable for any defect which may arise later in your equipment.
Even when the products are used within the guaranteed values, take into the consideration of incidence of break down and failure mode, possible to occur to semiconductor products. Measures on the systems such as redundant design, arresting the spread of fire or preventing glitch are recommended in order to prevent physical injury, fire, social damages, for example, by using the products.
- (7) When using products for which damp-proof packing is required, observe the conditions (including shelf life and amount of time let standing of unsealed items) agreed upon when specification sheets are individually exchanged.
- (8) This material may be not reprinted or reproduced whether wholly or partially, without the prior written permission of Matsushita Electric Industrial Co., Ltd.