

VERONICA-RS

~12° spot beam

TECHNICAL SPECIFICATIONS:

Dimensions	Ø 26 mm
Height	12.2 mm
Fastening	glue, pin
Colour	clear
Box size	480 x 280 x 300 mm
Box weight	10.1 kg
Quantity in Box	1980 pcs
ROHS compliant	yes ⓘ



MATERIAL SPECIFICATIONS:

Component	Type	Material	Colour
VERONICA-RS	Lens	PMMA	clear

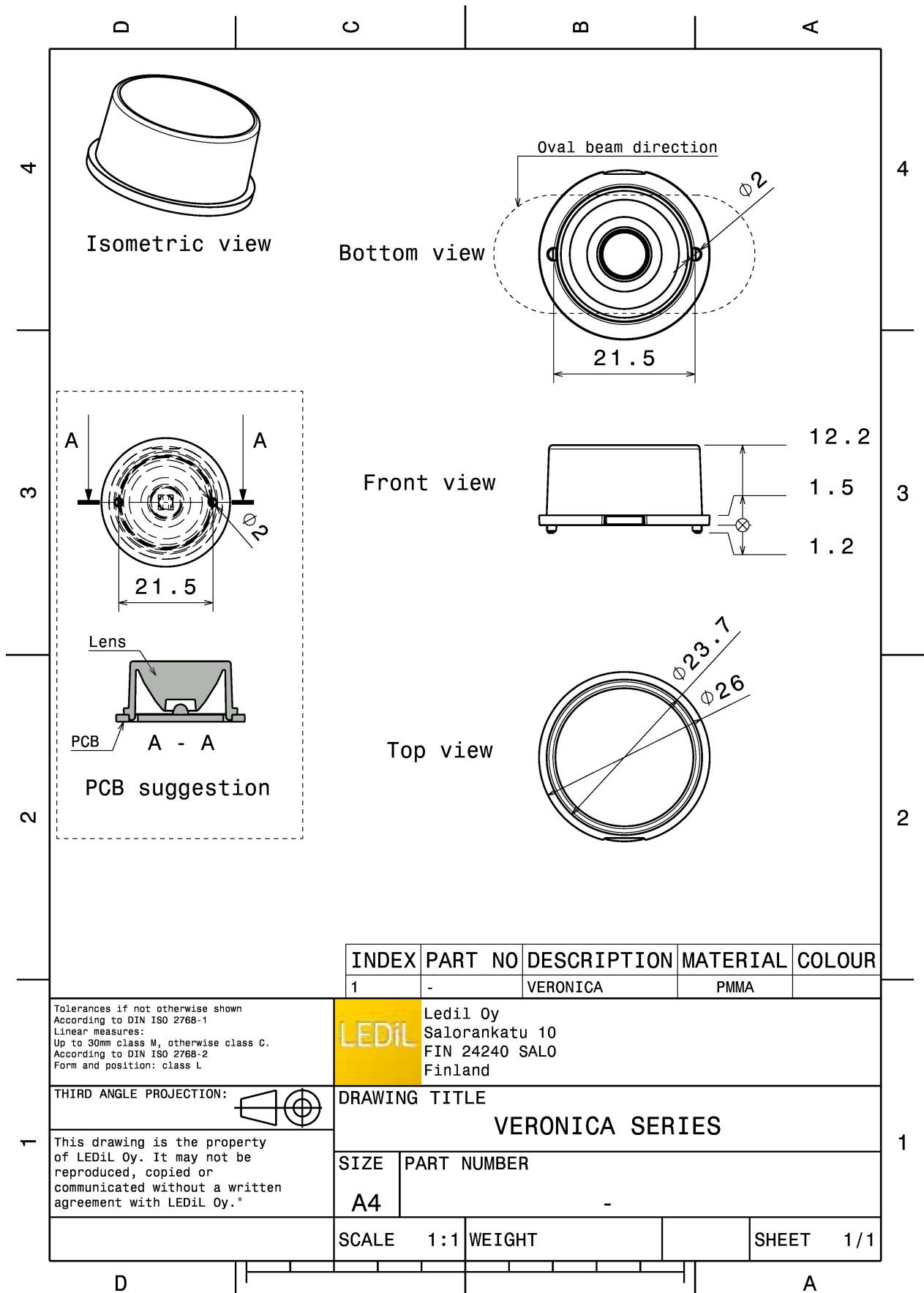

PHOTOMETRIC DATA (MEASURED):



LED XB-H
 FWHM 11.0°
 Efficiency 89 %
 Peak intensity 15.900 cd/lm
 Required components:

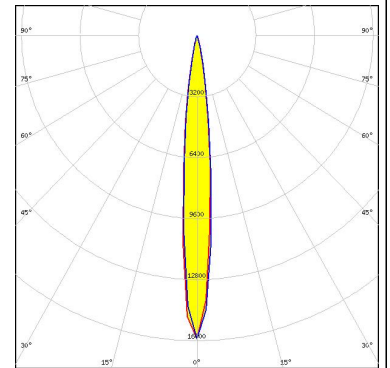
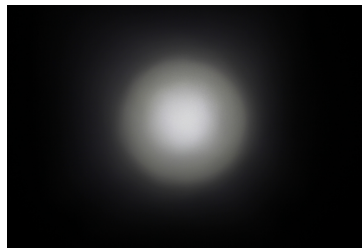

LED XM-L2
 FWHM 16.0°
 Efficiency 90 %
 Peak intensity 8.500 cd/lm
 Required components:

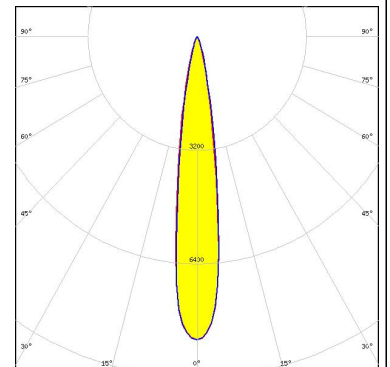
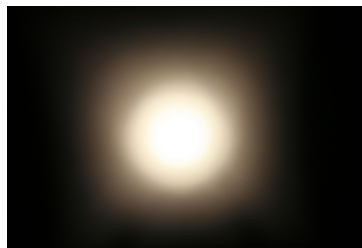

LED XP-G
 FWHM 12.0°
 Efficiency 90 %
 Peak intensity 18.400 cd/lm
 Required components:

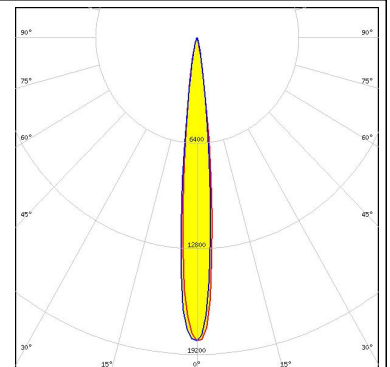
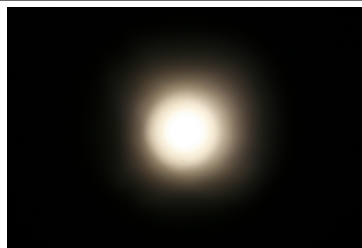

LED XP-G2
 FWHM 10.0°
 Efficiency 90 %
 Peak intensity 19.000 cd/lm
 Required components:

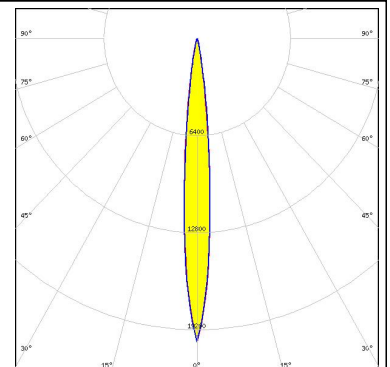

PHOTOMETRIC DATA (MEASURED):

LUMILEDS

LED LUXEON A
 FWHM 13.0°
 Efficiency 89 %
 Peak intensity 14.700 cd/lm
 Required components:

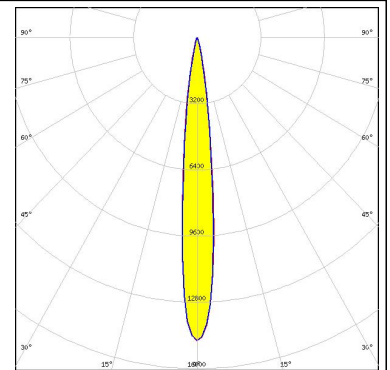

LUMILEDS

LED LUXEON Rebel
 FWHM 12.0°
 Efficiency 88 %
 Peak intensity 14.900 cd/lm
 Required components:

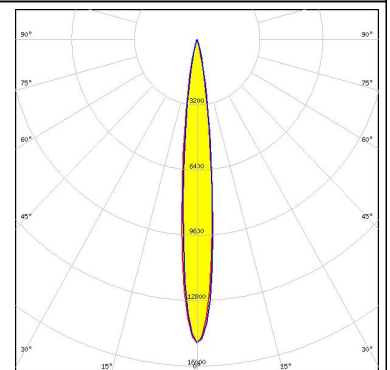

NICHIA

LED NCSxx19A
 FWHM 13.0°
 Efficiency 86 %
 Peak intensity 15.000 cd/lm
 Required components:

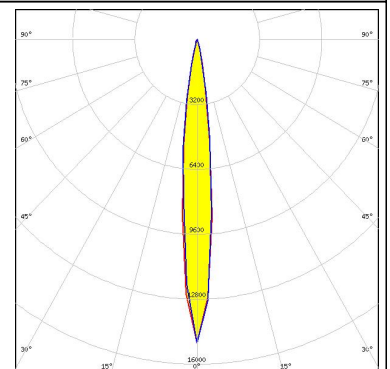

NICHIA

LED NVSW3x9A
 FWHM 13.0°
 Efficiency 89 %
 Peak intensity 10.300 cd/lm
 Required components:

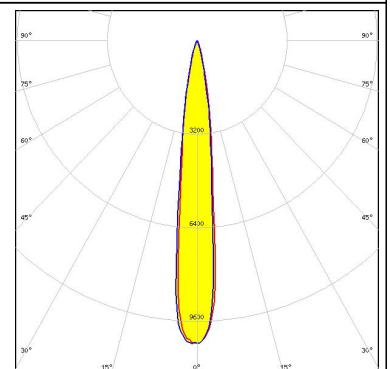

PHOTOMETRIC DATA (MEASURED):



LED NVSxx19A
 FWHM 14.0°
 Efficiency 85 %
 Peak intensity 10.000 cd/lm
 Required components:

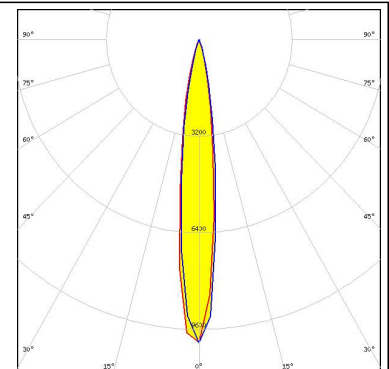
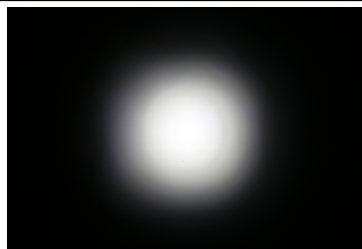

LED NVSxx19B/NVSxx19C
 FWHM 13.0°
 Efficiency 87 %
 Peak intensity 12.200 cd/lm
 Required components:

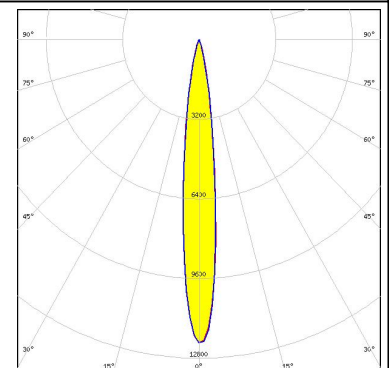

LED LH351Z
 FWHM 11.0°
 Efficiency 89 %
 Peak intensity 19.900 cd/lm
 Required components:

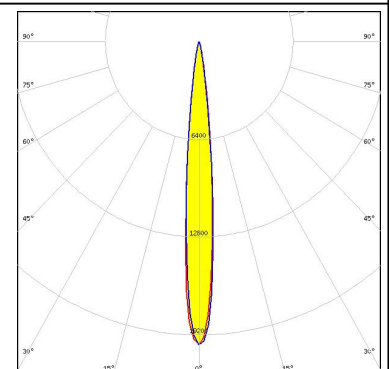
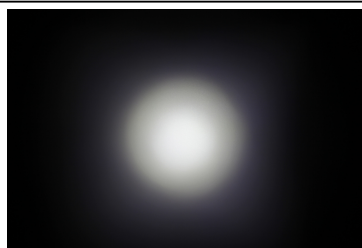

SEOUL SEMICONDUCTOR

LED Z8Y22P
 FWHM 11.0°
 Efficiency 87 %
 Peak intensity 10.400 cd/lm
 Required components:

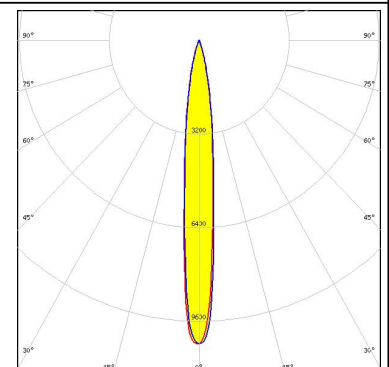

PHOTOMETRIC DATA (SIMULATED):

OSRAM

Opto Semiconductors

LED OSCONIQ P 3737 (3W version)
FWHM 15.0°
Efficiency 94 %
Peak intensity 10.450 cd/lm
Required components:

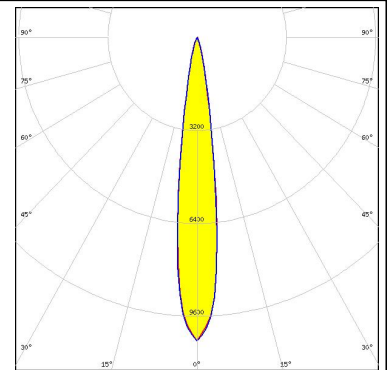

OSRAM

Opto Semiconductors

LED Oslon Square Gen3
FWHM 9.9°
Efficiency 94 %
Peak intensity 21.300 cd/lm
Required components:

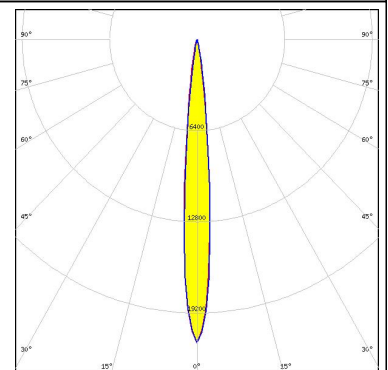

SAMSUNG

LED LH351B
FWHM 12.0°
Efficiency %
Peak intensity cd/lm
Required components:

GENERAL INFORMATION:

NOTE: The typical beam angle will be changed by different color, chip size and chip position tolerance. The typical total beam angle is the full angle measured where the luminous intensity is half of the peak value.

MATERIALS:

As part of our continuous research and improvement processes, and to ensure the best possible quality and availability of our products, LEDiL reserves the right to change material grades without notice.

PRODUCT DATA USER AGREEMENT AND DISCLAIMER:

The measured data in the provided downloadable LEDiL Product Datasheets and Mechanical 2D-Drawings is rounded and provided as reference for planning. LEDiL Oy's optical specifications have been verified by conducting performance testing of the products in accordance with the company's quality system. The reported data are averaged results of multiple measurements with typical variation. LEDiL Oy reserves the right to without prior notification make changes and improvements to its products.

LEDiL Oy assumes neither warranty, nor guarantee nor any other liability of any kind for the contents and correctness of the provided data. The provided data has been generated with highest diligence but the provided data may in reality not represent the complete possible variation range of all intrinsic parameters. Therefore, in certain cases a deviation from the provided data could occur.

LEDiL Oy reserves the right to undertake technical changes of its products without further notification which could lead to changes in the provided data. LEDiL Oy assumes no liability of any kind for the possible deviation from any provided data or any other damage resulting from the usage of the provided data.

The user agrees to this disclaimer and user agreement with the download or usage of the provided files.

LEDiL Oy

Joensuunkatu 13
FI-24240 SALO
Finland

LEDiL Inc.

228 West Page Street
Suite D
Sycamore IL 60178
USA

Local sales and technical support

[www.ledil.com/
where_to_buy](http://www.ledil.com/where_to_buy)

Shipping locations

Salo, Finland
Hong Kong, China

Distribution Partners

[www.ledil.com/
where_to_buy](http://www.ledil.com/where_to_buy)