

WITHOUT MOUNTING EARS
6-24 CIRCUIT
5559-**P1-225

WITH MOUNTING EARS
2-24 CIRCUIT
5559-**P-225

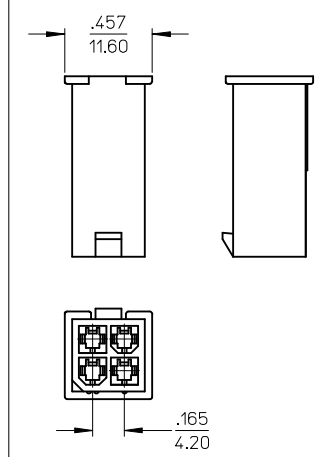

WITHOUT MOUNTING EARS
4 CIRCUIT
5559-04P1-225
SCALE: 2X

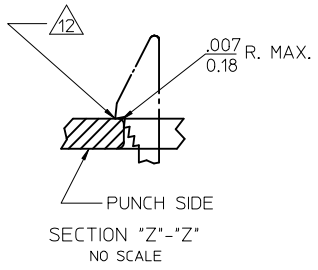
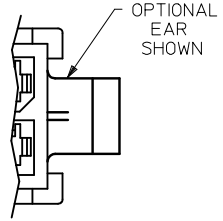
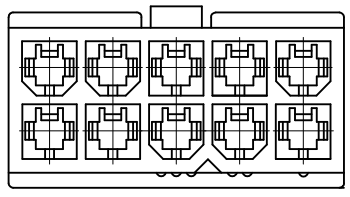
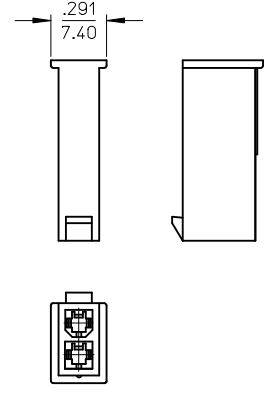

WITHOUT MOUNTING EARS
2 CIRCUIT
5559-02P1-225
SCALE: 2X

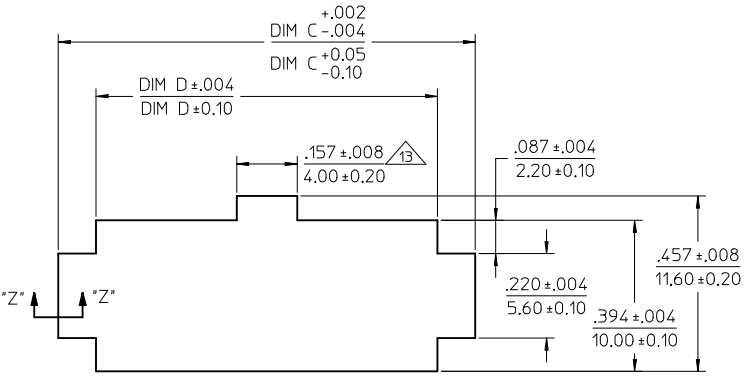

RECOMMENDED PANEL CUTOUT
THICKNESS: .032-.079 (0.80-2.00) \triangle

ADD NOT TOoled TO -24P EC NO: UCP2013-1370 DRWN:BBEE CHKD:JBELL APPR:FSMITH	2012/10/05	DESCRIPTION	QUALITY SYMBOLS
	2012/10/05		▽=0
	2012/10/05		▽=0
	2012/10/05		▽=0
	2012/10/05		▽=0

GENERAL TOLERANCES (UNLESS SPECIFIED)	
mm	INCH
4 PLACES ± .005	± .001
3 PLACES ± .010	± .002
2 PLACES ± .025	± .005
1 PLACE ± .038	± .010
ANGULAR ± 1/2°	
DRAFT WHERE APPLICABLE MUST REMAIN WITHIN DIMENSIONS	

DIMENSION STYLE		SCALE	
IN/MM		4:1	
DRAWN BY	DATE	DESIGN UNITS	THIRD ANGLE PROJECTION
LSCHMIDT	2007/04/25	METRIC	\odot \square
CHECKED BY	DATE	TITLE	
ADERR	2007/04/27	MINI-FIT JR PLUG	
APPROVED BY	DATE	2-24 CIRCUIT DUAL ROW	
FSMITH	2010/11/09	W/ & W/O EARS GLOW WIRE	
MATERIAL NO.	DOCUMENT NO.	MOLEX INCORPORATED	
SEE SHEET 2		SD-5559-425	

SHEET NO.	
1 OF 2	
THIS DRAWING CONTAINS INFORMATION THAT IS PROPRIETARY TO MOLEX INCORPORATED AND SHOULD NOT BE USED WITHOUT WRITTEN PERMISSION	

	13	12	11	10	9	8	7	6	5	4	3	2	1
J	PART NUMBER	ENGINEERING NO.	CKT SIZE	MOUNTING OPTION	DIM "A"	DIM "B"	DIM "C"	DIM "D"	PACKAGING SPECIFICATION				
	50-36-1678	5559-02P1-225	02	WITHOUT EARS	SEE SHEET 1	--	NOT APPLICABLE	NOT APPLICABLE	PK-5559-002				
	50-36-1679	5559-04P1-225	04	WITHOUT EARS	SEE SHEET 1	.165 / 4.20	NOT APPLICABLE	NOT APPLICABLE					
	50-36-1675	5559-06P1-225	06	WITHOUT EARS	.54 / 13.8	.331 / 8.40	NOT APPLICABLE	NOT APPLICABLE					
	50-36-1737	5559-08P1-225	08	WITHOUT EARS	.71 / 18.0	.496 / 12.60	NOT APPLICABLE	NOT APPLICABLE					
	50-36-1738	5559-10P1-225	10	WITHOUT EARS	.87 / 22.2	.661 / 16.80	NOT APPLICABLE	NOT APPLICABLE					
	26-01-3096	5559-12P1-225	12	WITHOUT EARS	1.04 / 26.4	.827 / 21.00	NOT APPLICABLE	NOT APPLICABLE					
I	NOT TOOLED	5559-14P1-225	14	WITHOUT EARS	1.21 / 30.6	.992 / 25.20	NOT APPLICABLE	NOT APPLICABLE					
	50-36-1676	5559-16P1-225	16	WITHOUT EARS	1.37 / 34.8	1.158 / 29.40	NOT APPLICABLE	NOT APPLICABLE					
	50-36-1677	5559-18P1-225	18	WITHOUT EARS	1.54 / 39.0	1.323 / 33.60	NOT APPLICABLE	NOT APPLICABLE					
	NOT TOOLED	5559-20P1-225	20	WITHOUT EARS	1.70 / 43.2	1.488 / 37.80	NOT APPLICABLE	NOT APPLICABLE					
	NOT TOOLED	5559-22P1-225	22	WITHOUT EARS	1.87 / 47.4	1.654 / 42.00	NOT APPLICABLE	NOT APPLICABLE					
H	NOT TOOLED	5559-24P1-225	24	WITHOUT EARS	2.03 / 51.6	1.819 / 46.20	NOT APPLICABLE	NOT APPLICABLE	PK-5559-002				
	50-36-1734	5559-02P-225	02	WITH EARS	.21 / 5.4	--	.425 / 10.80	.228 / 5.80	PK-5559-001				
	50-36-1735	5559-04P-225	04	WITH EARS	.38 / 9.6	.165 / 4.20	.591 / 15.00	.394 / 10.00					
	50-36-1736	5559-06P-225	06	WITH EARS	.54 / 13.8	.331 / 8.40	.756 / 19.20	.559 / 14.20					
	50-36-1716	5559-08P-225	08	WITH EARS	.71 / 18.0	.496 / 12.60	.921 / 23.40	.724 / 18.40					
G	50-36-1739	5559-10P-225	10	WITH EARS	.87 / 22.2	.661 / 16.80	1.087 / 27.60	.890 / 22.60					
	50-36-1869	5559-12P-225	12	WITH EARS	1.04 / 26.4	.827 / 21.00	1.252 / 31.80	1.055 / 26.80					
	50-36-1876	5559-14P-225	14	WITH EARS	1.21 / 30.6	.992 / 25.20	1.417 / 36.00	1.224 / 31.10					
	50-36-2273	X 5559-16P-225	16	WITH EARS	1.37 / 34.8	1.158 / 29.40	1.583 / 40.20	1.390 / 35.30					
	26-01-3187	5559-18P-225	18	WITH EARS	1.54 / 39.0	1.323 / 33.60	1.748 / 44.40	1.555 / 39.50					
	NOT TOOLED	5559-20P-225	20	WITH EARS	1.70 / 43.2	1.488 / 37.80	1.913 / 48.60	1.720 / 43.70					
F	NOT TOOLED	5559-22P-225	22	WITH EARS	1.87 / 47.4	1.654 / 42.00	2.079 / 52.80	1.886 / 47.90					
	46999-0166	X 5559-24P-225	24	WITH EARS	2.03 / 51.6	1.819 / 46.20	2.244 / 57.00	2.051 / 52.10	PK-5559-001				

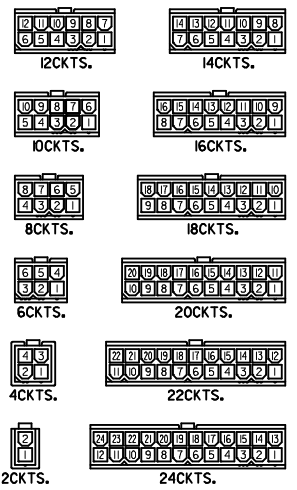

REFERENCE FOR CIRCUIT NUMBER ORIENTATION (OPTIONAL EARS NOT SHOWN)

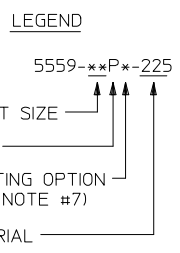

- NOTES:**
- MATERIAL: "225" = NYLON (PA6), UL94V-0, COLOR: BLACK; IEC 60335-1, 4th EDITION GLOW WIRE CAPABLE.
 - FINISH: NOT APPLICABLE
 - PRODUCT SPECIFICATION: PS-5556-001
 - PACKAGING: SEE CHART
 - PART MATES WITH MOLEX RECEPTACLE #5557.
 - PART TO BE USED WITH MOLEX MALE TERMINAL #5558.
 - MOUNTING OPTIONS: "BLANK" = WITH EARS "1" = WITHOUT EARS
 - PART IS NOT DESIGNED FOR CURRENT SHARING.
 - CONNECTORS ARE NOT TO BE MATED OR UNMATED WHILE CIRCUITS ARE LIVE.
 - WIRES ARE TO BE DRESSED IN SUCH A MANNER TO ALLOW THE TERMINALS TO FLOAT FREELY IN THE POCKET.
 - PART CONFORMS TO CLASS "B" REQUIREMENTS OF COSMETIC SPECIFICATION PS-45499-002 WITH THE EXCEPTION OF DISCOLORATION, FLASH AND SINK MEET CLASS "C" REQUIREMENTS.
 - PANEL HOLE TO PUNCHED OUT IN THE SAME DIRECTION AS INSERTION INTO THE PANEL.
 - ON 2 CIRCUIT PARTS THIS DIMENSION IS ALLOWABLE UP TO DIMENSION "D".
 - TO BE MEASURED AT SURFACE [A]

SEE SHEET 1 EC NO: UCP2013-1370 DRWN:BBEE 2012/10/05 CHKD:JBELL 2012/10/05 APPR:FSMITH 2012/10/25 REV: A9	QUALITY SYMBOLS ▽=0 ▽=0 ▽=0	GENERAL TOLERANCES (UNLESS SPECIFIED)		DIMENSION STYLE IN/MM		SCALE 1:1	DESIGN UNITS METRIC	THIRD ANGLE PROJECTION		
		4 PLACES ± --- INCH 3 PLACES ± --- INCH 2 PLACES ± 0.25 INCH 1 PLACE ± 0.38 INCH	± --- mm ± .010 mm ± .015 mm ± --- mm	DRAWN BY LSCHMIDT	DATE 2007/04/25	TITLE MINI-FIT JR PLUG 2-24 CIRCUIT DUAL ROW W/ & W/O EARS GLOW WIRE		MOLEX INCORPORATED		SHEET NO. 2 OF 2
		DRAFT WHERE APPLICABLE MUST REMAIN WITHIN DIMENSIONS		CHECKED BY ADERR	DATE 2007/04/27	APPROVED BY FSMITH		DATE 2010/11/09	DOCUMENT NO. SD-5559-425	

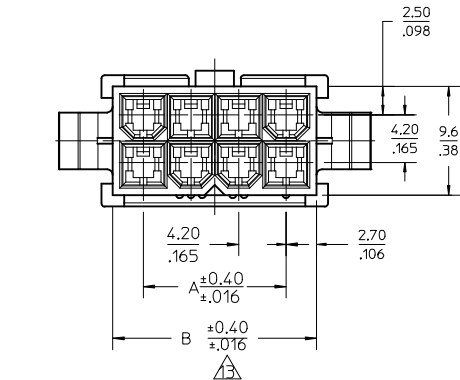
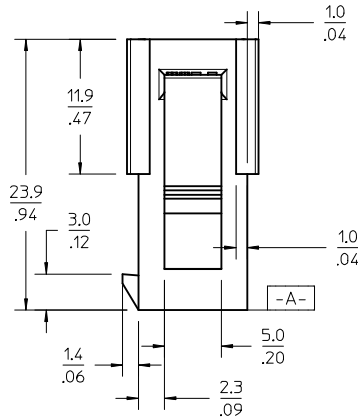
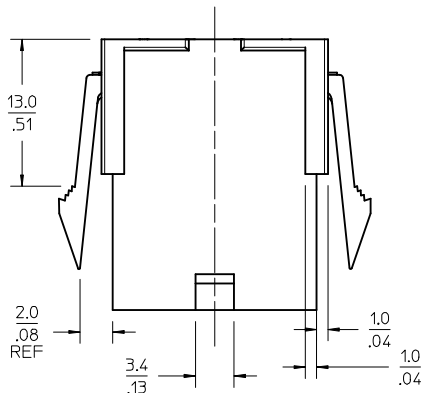
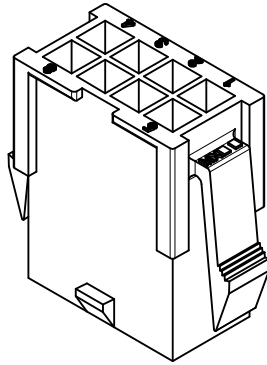
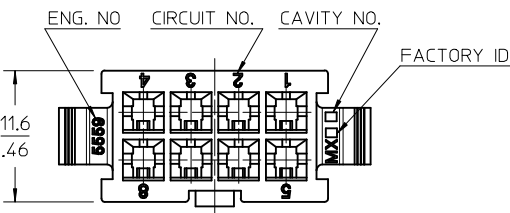

NOTES:

- 1) MATERIAL:
 - *"BLANK" = NYLON 6/6, 94V-2, COLOR: NATURAL.
 - *"BL" = NYLON 6/6, 94V-2, COLOR: BLACK.
 - *"BU" = NYLON 6/6, 94V-2, COLOR: BLUE.
 - *"RE" = NYLON 6/6, 94V-2, COLOR: RED.
 - *"210" = NYLON 6/6, 94V-0, COLOR: NATURAL.
 - *"400" = NYLON 6/6, 94V-0, COLOR: BLACK.
 - 2) FINISH: NOT APPLICABLE
 - 3) PRODUCT SPECIFICATION: PS-5556-001
 - 4) PACKAGING: BULK
 - 5) PART MATES WITH MOLEX RECEPTACLE #5557.
 - 6) PART TO BE USED WITH MOLEX MALE TERMINAL #5558.
 - 7) PART IS NOT DESIGNED FOR CURRENT SHARING.
 - 8) CONNECTORS ARE NOT TO BE MATED OR UNMATED WHILE CIRCUITS ARE LIVE.
 - 9) WIRES ARE TO BE DRESSED IN SUCH A MANNER TO ALLOW THE TERMINALS TO FLOAT FREELY IN THE POCKET.
 - 10) PART CONFORMS TO CLASS "B" REQUIREMENTS OF COSMETIC SPECIFICATION PS-45499-002 WITH THE EXCEPTION OF DISCOLORATION, FLASH AND SINK MEET CLASS "C" REQUIREMENTS.
- ▲ ON 2 CIRCUITS PARTS THIS DIMENSION IS ALLOWABLE UP TO "D" DIMENSION.
 ▲ PANEL HOLE TO BE PUNCHED OUT IN THE SAME DIRECTION AS INSERTION INTO THE PANEL.
 ▲ TO BE MEASURED AT SURFACE [-A-]

LEGEND

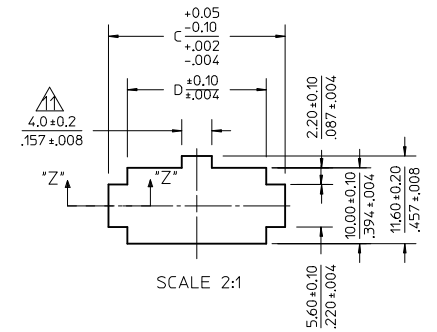
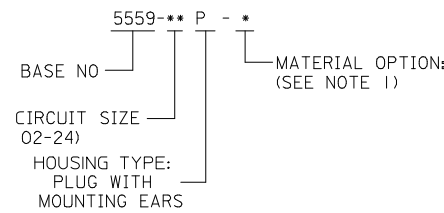

▲ RECOMMENDED PANEL HOLE DIMENSIONS
(THICKNESS : 0.8-2.0/.032-.079)

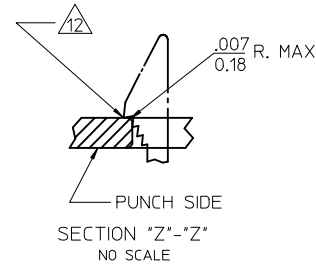

52.1/2.051	57.0/2.244	51.6/2.031	46.2/1.819	24
47.9/1.886	52.8/2.079	47.4/1.866	42.0/1.654	22
43.7/1.720	48.6/1.913	43.2/1.701	37.8/1.488	20
39.5/1.555	44.4/1.748	39.0/1.535	33.6/1.323	18
35.3/1.390	40.2/1.583	34.8/1.370	29.4/1.158	16
31.1/1.224	36.0/1.417	30.6/1.205	25.2/992	14
26.8/1.055	31.8/1.252	26.4/1.039	21.0/.827	12
22.6/.890	27.6/1.087	22.2/.874	16.8/.661	10
18.4/.724	23.4/.921	18.0/.709	12.6/.496	8
14.2/.559	19.2/.756	13.8/.543	8.4/.331	6
10.0/.394	15.0/.591	9.6/.378	4.2/.165	4
5.8/.228	10.8/.425	5.4/.213	---	2
	D	C	B	A

ADD NOTE 13 EC NO: UCP2013-1698 DRWN:BBEE CHKD:JBELL APPR:FSMITH 2012/11/01 2012/11/01 2012/11/06	QUALITY SYMBOLS	GENERAL TOLERANCES (UNLESS SPECIFIED)	DIMENSION STYLE	SCALE	DESIGN UNITS	THIRD ANGLE PROJECTION
	▽=0	mm INCH	MM/IN	3:1	METRIC	
	▽=0	4 PLACES ± --- ± ---	DRAWN BY DATE	H.HIRAMOTO 1988/10/14	TITLE	
	▽=0	3 PLACES ± --- ±.012	CHECKED BY DATE	Y.YAMADA 1988/10/21	MINI, FIT JR DUAL ROW 2-24CKT PLUG HOUSING WITH EARS	
	2 PLACES ±.30 ±.016	APPROVED BY DATE	M.ENOMOTO 1988/10/24	MOLEX INCORPORATED		
	1 PLACE ±.40 ± ---	ANGULAR ± 3 °	MATERIAL NO.	DOCUMENT NO.	SD-5559-NP	
		DRAFT WHERE APPLICABLE MUST REMAIN WITHIN DIMENSIONS	SEE CHART	SHEET NO.		1 OF 2
J6	REV	THIS DRAWING CONTAINS INFORMATION THAT IS PROPRIETARY TO MOLEX INCORPORATED AND SHOULD NOT BE USED WITHOUT WRITTEN PERMISSION				

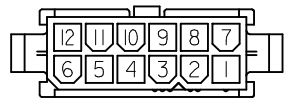

12CKTS.

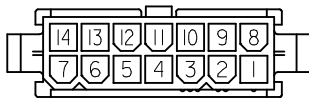

14CKTS.

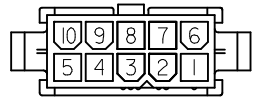

10CKTS.

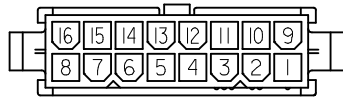

16CKTS.

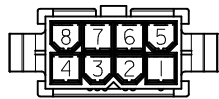

8CKTS.

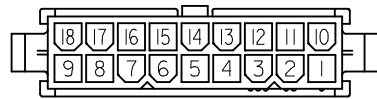

18CKTS.

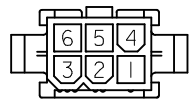

6CKTS.

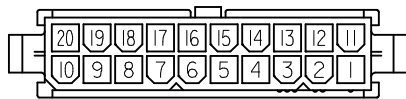

20CKTS.

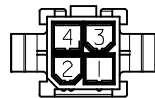

4CKTS.

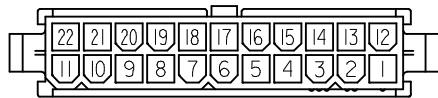

22CKTS.

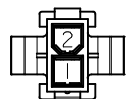

2CKTS.

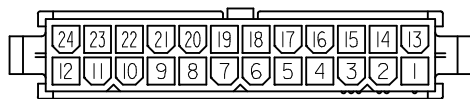

24CKTS.

CIRCUIT SIZE LAYOUT (SCALE : 2-1)

V-2 BLACK			V-0 BLACK		
EDP NO.	ENG. NO.	CIRCUIT	EDP NO.	ENG. NO.	CIRCUIT
46999-0157	5559-24P-BL	24	46999-0304	5559-24P-400	24
		22	46999-0303	5559-22P-400	22
39-02-8205	5559-20P-BL	20	46999-0302	5559-20P-400	20
		18	46999-0301	5559-18P-400	18
		16	46999-0300	5559-16P-400	16
		14	46999-0299	5559-14P-400	14
		2	46999-0298	5559-12P-400	2
		10	46999-0297	5559-10P-400	10
		8	46999-0296	5559-08P-400	8
39-02-8065	5559-06P-BL	6	46999-0295	5559-06P-400	6
39-02-8045	5559-04P-BL	4	46999-0294	5559-04P-400	4
		2	46999-0293	5559-02P-400	2

V-2 BLUE			V-2 RED			V-0 NATURAL			V-2 NATURAL		
EDP NO.	ENG. NO.	CIRCUIT	EDP NO.	ENG. NO.	CIRCUIT	EDP NO.	ENG. NO.	CIRCUIT	EDP NO.	ENG. NO.	CIRCUIT
		24			24	39-01-2246	5559-24P-210	24	39-01-2241	5559-24P	24
		22			22	↑ -2226	↑ -22P-210	22	↑ -2221	↑ -22P	22
		20			20	↑ -2206	↑ -20P-210	20	↑ -2201	↑ -20P	20
		18			18	↑ -2186	↑ -18P-210	18	↑ -2181	↑ -18P	18
		16			16	↑ -2166	↑ -16P-210	16	↑ -2161	↑ -16P	16
		14			14	↑ -2146	↑ -14P-210	14	↑ -2141	↑ -14P	14
		2			2	↑ -2126	↑ -12P-210	2	↑ -2121	↑ -12P	2
		10			10	↑ -2106	↑ -10P-210	10	↑ -2101	↑ -10P	10
		8			8	↑ -2086	↑ -08P-210	8	↑ -2081	↑ -08P	8
		6	39-02-8067	5559-06P-RE	6	↑ -2066	↑ -06P-210	6	↑ -2061	↑ -06P	6
39-02-8046	5559-04P-BU	4			4	↓ -2046	↓ -04P-210	4	↓ -2041	↓ -04P	4
		2			2	↓ -2026	↓ -02P-210	2	↓ -2021	↓ -02P	2

SEE SHEET 1 EC NO: UCP2013-1698 DRWN:BBEE 2012/11/01 CHKD:JBELL 2012/11/01 APPR:FSMITH 2012/11/06 REV: J6	QUALITY SYMBOLS ▽=0 ▽=0 ▽=0	GENERAL TOLERANCES (UNLESS SPECIFIED) <table border="1"> <tr> <th></th> <th>mm</th> <th>INCH</th> </tr> <tr> <td>4 PLACES</td> <td>± .10</td> <td>± .004</td> </tr> <tr> <td>3 PLACES</td> <td>± .12</td> <td>± .005</td> </tr> <tr> <td>2 PLACES</td> <td>± .16</td> <td>± .006</td> </tr> <tr> <td>1 PLACE</td> <td>± .30</td> <td>± .012</td> </tr> </table>		mm	INCH	4 PLACES	± .10	± .004	3 PLACES	± .12	± .005	2 PLACES	± .16	± .006	1 PLACE	± .30	± .012	DIMENSION STYLE MM/IN DRAWN BY: H. HIRAMOTO DATE: 1988/10/14 CHECKED BY: Y. YAMADA DATE: 1988/10/21 APPROVED BY: M. ENOMOTO DATE: 1988/10/24	SCALE 2:1 DESIGN UNITS <input checked="" type="checkbox"/> METRIC <input type="checkbox"/> THIRD ANGLE PROJECTION
		mm	INCH																
	4 PLACES	± .10	± .004																
	3 PLACES	± .12	± .005																
2 PLACES	± .16	± .006																	
1 PLACE	± .30	± .012																	
DRAFT WHERE APPLICABLE MUST REMAIN WITHIN DIMENSIONS		SEE CHART	MOLEX INCORPORATED SD-5559-NP																
		MATERIAL NO.	DOCUMENT NO.	SHEET NO. 2 OF 2															
THIS DRAWING CONTAINS INFORMATION THAT IS PROPRIETARY TO MOLEX INCORPORATED AND SHOULD NOT BE USED WITHOUT WRITTEN PERMISSION																			