

**User Manual**

## **PCA-6008VG**

**Celeron® M Processor Card with  
VGA/ Single Gigabit LAN/ HISA/  
(400 MHz FSB)**

**ADVANTECH**

*Enabling an Intelligent Planet*

---

## Copyright

The documentation and the software included with this product are copyrighted 2011 by Advantech Co., Ltd. All rights are reserved. Advantech Co., Ltd. reserves the right to make improvements in the products described in this manual at any time without notice. No part of this manual may be reproduced, copied, translated or transmitted in any form or by any means without the prior written permission of Advantech Co., Ltd. Information provided in this manual is intended to be accurate and reliable. However, Advantech Co., Ltd. assumes no responsibility for its use, nor for any infringements of the rights of third parties, which may result from its use.

## Acknowledgements

Intel®, Pentium® M and Celeron® are trademarks of Intel Corporation.  
Microsoft Windows® and MS-DOS are registered trademarks of Microsoft Corp.  
All other product names or trademarks are properties of their respective owners.

## Product Warranty (2 years)

Advantech warrants to you, the original purchaser, that each of its products will be free from defects in materials and workmanship for two years from the date of purchase.

This warranty does not apply to any products which have been repaired or altered by persons other than repair personnel authorized by Advantech, or which have been subject to misuse, abuse, accident or improper installation. Advantech assumes no liability under the terms of this warranty as a consequence of such events.

Because of Advantech's high quality-control standards and rigorous testing, most of our customers never need to use our repair service. If an Advantech product is defective, it will be repaired or replaced at no charge during the warranty period. For out-of-warranty repairs, you will be billed according to the cost of replacement materials, service time and freight. Please consult your dealer for more details.

If you think you have a defective product, follow these steps:

1. Collect all the information about the problem encountered. (For example, CPU speed, Advantech products used, other hardware and software used, etc.) Note anything abnormal and list any onscreen messages you get when the problem occurs.
2. Call your dealer and describe the problem. Please have your manual, product, and any helpful information readily available.
3. If your product is diagnosed as defective, obtain an RMA (return merchandise authorization) number from your dealer. This allows us to process your return more quickly.
4. Carefully pack the defective product, a fully-completed Repair and Replacement Order Card and a photocopy proof of purchase date (such as your sales receipt) in a shippable container. A product returned without proof of the purchase date is not eligible for warranty service.
5. Write the RMA number visibly on the outside of the package and ship it prepaid to your dealer.

# Declaration of Conformity

## CE

This product has passed the CE test for environmental specifications. Test conditions for passing included the equipment being operated within an industrial enclosure. In order to protect the product from being damaged by ESD (Electrostatic Discharge) and EMI leakage, we strongly recommend the use of CE-compliant industrial enclosure products.

## FCC Class A

Note: This equipment has been tested and found to comply with the limits for a Class A digital device, pursuant to part 15 of the FCC Rules. These limits are designed to provide reasonable protection against harmful interference when the equipment is operated in a commercial environment. This equipment generates, uses, and can radiate radio frequency energy and, if not installed and used in accordance with the instruction manual, may cause harmful interference to radio communications. Operation of this equipment in a residential area is likely to cause harmful interference in which case the user will be required to correct the interference at his own expense.

## Technical Support and Assistance

1. Visit the Advantech web site at <http://support.advantech.com> where you can find the latest information about the product.
2. Contact your distributor, sales representative, or Advantech's customer service center for technical support if you need additional assistance. Please have the following information ready before you call:
  - Product name and serial number
  - Description of your peripheral attachments
  - Description of your software (operating system, version, application software, etc.)
  - A complete description of the problem
  - The exact wording of any error messages

### PCA-6008 Comparison Table

Model	PCA-6008VG-06	PCA-6008VG-10	PCA-6008G2-00
North Bridge	910GMLE	910GMLE	915GME
VGA:Chipset integrated Intel Graphics Media Accelerator 900 onboard	yes	yes	yes
LAN 1: Realtek 8111B 10/100/1000Base-T	yes	yes	yes
LAN 2: Realtek 8111B 10/100/1000Base-T	no	no	yes
USB 2.0 port	4	4	8
COM port	2	2	6
LVDS function	no	no	yes
DVI function	no	no	yes
CF	Yes	Yes	Yes

## PCA-6008 DDR memory compatibility table

Brand	Size	Speed	ECC	Vendor PN	Advantech PN	Memory
Apacer	1GB	DDR2 533	N	78.01066.400	NA	SAMSUNG K4T51083QB-ZKD5 (128x4)
UG	512MB	DDR2 400	N	UG64T6400K8D U-4AM	NA	Micron 4WB42 D9CHL (64x8)
	1GB	DDR2 400	N	UG12T6400L8D U-4AM	NA	ELPIDA E5108AB-5C-E (64x8)
Transcend	256MB	DDR2 533	N	TS32MLQ64V5F	NA	SAMSUNG 443 K4T56083QF-GCD5 (32x8)
	512MB	DDR2 533	N	TS64MLQ64V5J	NA	ELPIDA E5108AB-5C-E (64x8)
	1GB	DDR2 533	N	TS128MLQ64V5J	NA	ELPIDA E5108AB-5C-E (64x8)
DSL	512MB	DDR2 533	N	NA	NA	Infineon HYB18T512 800AF37 FSS43331 (64x8)
	1GB	DDR2 533	N	NA	NA	ELPIDA E5108AE-5C-E (64x8)
Apacer (RoHS)	512MB	DDR2 533	N	78.91G66.420	NA	ELPIDA E5108AG-5C-E (64x8)
	1GB	DDR2 533	N	78.01G66.420	NA	ELPIDA E5108AG-5C-E (64x8)
	512MB	DDR2 667	N	78.91G92.420	NA	ELPIDA E5108AG-6E-E (64x8)
	1GB	DDR2 667	N	78.01G92.420	NA	ELPIDA E5108AG-6E-E (64x8)
Transcend (RoHS)	256MB	DDR2 533	N	TS32MLQ64V5M	96D2-256M533N-N-TR	Infineon HYB18T512160AF3.7 3VV21710 (32x16)
	512MB	DDR2 533	N	TS64MLQ64V5J	96D2-512M533N-N-TR1	SEC K4T51083QC ZCD5 (64X8)
	1GB	DDR2 533	N	TS128MLQ64V5J	96D2-1G533NN-TR1	SEC K4T51083QC ZCD5 (64X8)
	512MB	DDR2 667	N	TS64MLQ64V6J	96D2-512M667N-N-TR	SEC K4T51083QC ZCE6 (64x8)
	512MB	DDR2 667	N	TS64MLQ64V6J		Micron 5XB32D9DCL (64x8)
	1GB	DDR2 667	N	TS2QNJ23450-6S		SEC K4T51083QE ZCE6 (64x8)
DSL	1GB	DDR2 667	N	NA	NA	ELPIDA E5108AGBG-6E-E (64x8)

## Document Feedback

To assist us in making improvements to this manual, we would welcome comments and constructive criticism. Please send all such - in writing to: support@advan-tech.com

## Packing List

Before setting up the system, check that the items listed below are included and in good condition. If any item does not accord with the table, please contact your dealer immediately.

- 1 PCA-6008 Celeron processor-based single board computer
- 1 PCA-6008 Startup Manual
- 1 CD with driver utility and manual (in PDF format)
- 1 FDD cable P/N: 1700340640
- 1 Ultra ATA 66/100 HDD cables P/N: 1701400452
- 2 Serial ATA HDD data cables P/N: 1700003194
- 2 Serial ATA HDD power cables P/N: 1703150102
- 1 Printer (parallel) port & COM port cable kit P/N: 1700060305
- 1 Dual COM port cable kit G2 version only P/N: 1701092300
- 1 Y cable for PS/2 keyboard and PS/2 mouse P/N: 1700060202
- 1 Four-USB port cables P/N: 1700008461
- Jumper pack P/N: 9689000068
- 1 ATX 12V power converter cable P/N: 170304015K

---

## Safety Instructions

1. Read these safety instructions carefully.
2. Keep this User Manual for later reference.
3. Disconnect this equipment from any AC outlet before cleaning. Use a damp cloth. Do not use liquid or spray detergents for cleaning.
4. For plug-in equipment, the power outlet socket must be located near the equipment and must be easily accessible.
5. Keep this equipment away from humidity.
6. Put this equipment on a reliable surface during installation. Dropping it or letting it fall may cause damage.
7. The openings on the enclosure are for air convection. Protect the equipment from overheating. **DO NOT COVER THE OPENINGS.**
8. Make sure the voltage of the power source is correct before connecting the equipment to the power outlet.
9. Position the power cord so that people cannot step on it. Do not place anything over the power cord.
10. All cautions and warnings on the equipment should be noted.
11. If the equipment is not used for a long time, disconnect it from the power source to avoid damage by transient overvoltage.
12. Never pour any liquid into an opening. This may cause fire or electrical shock.
13. Never open the equipment. For safety reasons, the equipment should be opened only by qualified service personnel.
14. If one of the following situations arises, get the equipment checked by service personnel:
  15. The power cord or plug is damaged.
  16. Liquid has penetrated into the equipment.
  17. The equipment has been exposed to moisture.
  18. The equipment does not work well, or you cannot get it to work according to the user's manual.
  19. The equipment has been dropped and damaged.
  20. The equipment has obvious signs of breakage.
21. **DO NOT LEAVE THIS EQUIPMENT IN AN ENVIRONMENT WHERE THE STORAGE TEMPERATURE MAY GO BELOW -20° C (-4° F) OR ABOVE 60° C (140° F). THIS COULD DAMAGE THE EQUIPMENT. THE EQUIPMENT SHOULD BE IN A CONTROLLED ENVIRONMENT.**
22. **CAUTION: DANGER OF EXPLOSION IF BATTERY IS INCORRECTLY REPLACED. REPLACE ONLY WITH THE SAME OR EQUIVALENT TYPE RECOMMENDED BY THE MANUFACTURER, DISCARD USED BATTERIES ACCORDING TO THE MANUFACTURER'S INSTRUCTIONS.**
23. The sound pressure level at the operator's position according to IEC 704-1:1982 is no more than 70 dB (A).

**DISCLAIMER:** This set of instructions is given according to IEC 704-1. Advantech disclaims all responsibility for the accuracy of any statements contained herein.

## Safety Precaution - Static Electricity

Follow these simple precautions to protect yourself from harm and the products from damage.

- To avoid electrical shock, always disconnect the power from your PC chassis before you work on it. Don't touch any components on the CPU card or other cards while the PC is on.
- Disconnect power before making any configuration changes. The sudden rush of power as you connect a jumper or install a card may damage sensitive electronic components.





# Contents

## Chapter 1 Hardware Configuration .....1

1.1	Introduction .....	2
1.2	Features .....	2
1.3	Specifications .....	3
1.3.1	System .....	3
1.3.2	Memory .....	3
1.3.3	Input/Output .....	3
1.3.4	VGA Interface .....	3
1.3.5	Ethernet LAN .....	3
1.3.6	Industrial Features .....	4
1.3.7	Mechanical and Environmental Specifications.....	4
1.4	Jumpers and Connectors .....	4
	Table 1.1: Jumpers.....	5
	Table 1.2: Connectors .....	5
1.5	Board Layout: Jumper and Connector Locations.....	6
	Figure 1.1: Jumper and Connector locations.....	6
1.6	PCA-6008 Block Diagram .....	7
	Figure 1.2: Block diagram.....	7
1.7	Safety Precautions .....	7
1.8	Jumper Settings .....	8
1.8.1	How to Set Jumpers.....	8
1.8.2	CMOS Clear (CMOS1) .....	8
	Table 1.3: CMOS1 .....	8
1.8.3	Watchdog Timer Output (JWDT1) .....	8
	Table 1.4: Watchdog timer output (JWDT1).....	9
1.8.4	JSETCOM2 (RS232/422/485 Jumper Setting (JSETCOM2)).....	9
1.9	System Memory .....	9
1.9.1	CPU FSB and Memory Speed .....	10
1.9.2	Dual Channel Configuration.....	10
1.10	Memory Installation Procedures.....	10
1.11	Processor Installation.....	10

## Chapter 2 Connecting Peripherals .....11

2.1	Introduction .....	12
2.2	1st (IDE1) IDE Connector .....	12
2.3	Floppy Drive Connector (FDD1).....	12
2.4	Parallel Port (LPT1).....	13
2.5	USB Ports (USB12, USB34) .....	14
2.6	VGA Connector (VGA1) .....	14
2.7	Ethernet Connector (LAN1).....	15
2.8	Serial Ports (COM1, COM2) .....	15
2.9	PS/2 Keyboard/Mouse Connector (KBMS1) .....	16
2.10	External Keyboard Connector (KBMS2) .....	16
2.11	CPU Fan Connector (CPUFAN1).....	17
2.12	Front Panel Connectors (JFP1, JFP2, JFP3).....	17
2.12.1	ATX Soft Power Switch (JFP1 / PWR_SW).....	17
2.12.2	Reset (JFP1 / RESET).....	18
2.12.3	HDD LED (JFP2 / HDDLED).....	18
2.12.4	SM Bus Connector (JFP2 / SNMP).....	18
2.12.5	External Speaker (JFP2 / SPEAKER).....	18
2.12.6	Power LED and Keyboard Lock Connector (JFP3 / PWR_LED&KEY LOCK) .....	18
	Table 2.1: ATX power supply LED status (No support for AT pow-	

	er .....	18
2.13	ATX Feature Connector (JATXF1).....	19
2.14	AC-97 Audio Interface (AC-97) .....	19
2.15	Serial ATA Interface (SATA1, SATA2).....	19
2.16	Auxiliary 4-pin Power Connector (ATX12V1).....	20
2.17	Hardware Monitor Alarm (JWDT1+JOBS1+JIR1).....	20
	Table 2.2: Hardware Monitor Alarm (JOBS1) setting .....	21
2.18	Case Open Connector (JCASE1) .....	21
2.19	LAN1LED (LANLED1).....	21
2.20	GPIO Pin Header (GPIO1) .....	22

## Chapter 3 Award BIOS Setup ..... 23

3.1	Introduction .....	24
3.1.1	CMOS RAM Auto-backup and Restore .....	24
3.2	Entering Setup .....	24
	Figure 3.1 Award BIOS Setup initial screen .....	24
3.3	Standard CMOS Setup .....	25
	Figure 3.2 Standard CMOS Features Screen .....	25
3.3.1	Date .....	25
3.3.2	Time.....	25
3.3.3	IDE Channel 0/1 Master/Slave .....	25
3.3.4	Drive A / Drive B .....	25
3.3.5	Halt On.....	26
3.3.6	Memory.....	26
3.4	Advanced BIOS Features .....	26
	Figure 3.3 Advanced BIOS features screen .....	26
3.4.1	CPU Features .....	26
3.4.2	Hard Disk Boot Priority .....	27
3.4.3	Virus Warning .....	27
3.4.4	CPU L1 & L2 Cache .....	27
3.4.5	Quick Power On Self Test .....	27
3.4.6	First/Second/Third Boot Device .....	27
3.4.7	Boot Other Device .....	27
3.4.8	Swap Floppy Drive.....	27
3.4.9	Boot Up Floppy Seek.....	27
3.4.10	Boot Up NumLock Status .....	27
3.4.11	Gate A20 Option .....	27
3.4.12	Typematic Rate Setting .....	27
3.4.13	Typematic Rate (Chars/Sec) .....	27
3.4.14	Typematic Delay (msec).....	28
3.4.15	Security Option .....	28
3.4.16	APIC Mode .....	28
3.4.17	MPS Version Control For OS.....	28
3.5	Advanced Chipset Features.....	29
	Figure 3.4 Advanced chipset features screen .....	29
3.5.1	DRAM Timing Selectable.....	29
3.5.2	CAS Latency Time.....	29
3.5.3	DRAM RAS# to CAS# Delay .....	29
3.5.4	DRAM RAS# Precharge .....	29
3.5.5	Precharge Delay (t RAS) .....	30
3.5.6	System Memory Frequency.....	30
3.5.7	System BIOS Cacheable .....	30
3.5.8	Video BIOS Cacheable.....	30
3.5.9	Memory Hole At 15M-16M.....	30
3.5.10	PCI-Express Root Port Func .....	30
3.5.11	On-Chip Frame Buffer Size .....	30
3.5.12	DVMT Mode.....	30
3.5.13	DVMT/ FIXED Memory Size .....	30

	3.5.14	Boot Display.....	31
	3.5.15	Init Display First .....	31
3.6		Integrated Peripherals.....	31
		Figure 3.5 Integrated peripherals.....	31
		Figure 3.6 On-Chip IDE Device .....	31
	3.6.1	IDE HDD Block Mode .....	32
	3.6.2	IDE DMA Transfer Access .....	32
	3.6.3	On-Chip IDE Device.....	32
	3.6.4	On-Chip Serial ATA .....	32
		Figure 3.7 Onboard Device.....	32
	3.6.5	USB Controller .....	32
	3.6.6	USB 2.0 Controller .....	32
	3.6.7	USB Keyboard/Mouse Support.....	33
	3.6.8	AC-97 Audio.....	33
	3.6.9	Onboard LAN1 Control .....	33
		Figure 3.8 Super I/O Device .....	33
	3.6.10	Onboard FDC Controller .....	33
	3.6.11	Onboard Serial Port 1 .....	33
	3.6.12	Onboard Serial Port 2 .....	33
	3.6.13	UART Mode Select .....	33
	3.6.14	RxD, TxD Active.....	33
	3.6.15	IR Transmission Delay.....	34
	3.6.16	UR2 Duplex Mode.....	34
	3.6.17	Use IR Pins.....	34
	3.6.18	Onboard Parallel Port .....	34
	3.6.19	Parallel Port Mode .....	34
	3.6.20	EPP Mode Select.....	34
	3.6.21	ECP Mode Use DMA .....	34
3.7		Power Management Setup.....	35
		Figure 3.9 Power management setup screen (1) .....	35
	3.7.1	PCI Express PM Function.....	35
	3.7.2	Power Supply Type.....	35
	3.7.3	ACPI Function.....	35
	3.7.4	Power Management.....	35
		Table 3.1: D Power Down = 15 min.....	36
		Table 3.2: ,Power Saving .....	36
	3.7.5	Video Off Method .....	36
	3.7.6	Video Off In Suspend.....	36
	3.7.7	Suspend Type.....	36
	3.7.8	Modem Use IRQ .....	36
	3.7.9	Suspend Mode.....	36
	3.7.10	HDD Power Down.....	36
	3.7.11	Soft-Off by PWR-BTTN.....	36
	3.7.12	PowerOn by Modem .....	36
	3.7.13	PowerOn by LAN .....	36
	3.7.14	PowerOn by Alarm.....	37
	3.7.15	Primary IDE 0.....	37
3.8		PnP/PCI Configurations .....	37
		Figure 3.10PnP/PCI configurations screen.....	37
	3.8.1	PNP OS Installed .....	37
	3.8.2	Reset Configuration Data.....	37
	3.8.3	Resources Controlled By .....	37
	3.8.4	PCI/VGA Palette Snoop.....	37
	3.8.5	Maximum Payload Size .....	38
3.9		PC Health Status.....	38
		Figure 3.11PC Health Status Screen.....	38
	3.9.1	Case Open Warning .....	38
	3.9.2	CPU Warning Temperature .....	38
	3.9.3	Current CPU Temperature.....	38
	3.9.4	CPU FAN Speed.....	38

	3.9.5	VCORE and Other Voltages .....	38
	3.9.6	Shutdown Temperature .....	38
3.10		Frequency / Voltage Control .....	39
		Figure 3.12 Spread Spectrum Control screen .....	39
	3.10.1	Spread Spectrum .....	39
3.11		Password Setting .....	39
3.12		Save & Exit Setup .....	40
3.13		Exit Without Saving .....	40
<b>Chapter</b>	<b>4</b>	<b>Chipset Software Install Utility .....</b>	<b>41</b>
	4.1	Before you Begin .....	42
	4.2	Introduction .....	42
	4.3	Windows XP Driver Setup .....	42
<b>Chapter</b>	<b>5</b>	<b>VGA Setup .....</b>	<b>47</b>
	5.1	Introduction .....	48
	5.2	Windows XP Driver Setup .....	48
<b>Chapter</b>	<b>6</b>	<b>LAN Configuration .....</b>	<b>51</b>
	6.1	Introduction .....	52
	6.2	Features .....	52
	6.3	Installation .....	52
	6.4	Win XP Driver Setup (Realtek RTL8111B) .....	53
<b>Chapter</b>	<b>7</b>	<b>USB 2.0 Configuration .....</b>	<b>55</b>
	7.1	Introduction .....	56
	7.2	Features .....	56
	7.3	Installation .....	56
<b>Appendix A</b>		<b>Programming the Watchdog .....</b>	<b>57</b>
	A.1	Programming the Watchdog Timer .....	58
		A.1.1 Watchdog timer overview .....	58
		A.1.2 Reset/ Interrupt selection .....	58
		A.1.3 Programming the Watchdog Timer .....	58
		Table A.1: Watchdog Timer Registers .....	60
		A.1.4 Example Program .....	61
<b>Appendix B</b>		<b>Programming the GPIO .....</b>	<b>65</b>
	B.1	Sample Code .....	66
<b>Appendix C</b>		<b>Pin Assignments .....</b>	<b>69</b>
	C.1	IDE Hard Drive Connector (IDE1) .....	70
		Table C.1: IDE hard drive connector (IDE1) .....	70
	C.2	Floppy Drive Connector (FDD1) .....	71
		Table C.2: Floppy drive connector (FDD1) .....	71
	C.3	Parallel Port Connector (LPT1) .....	72
		Table C.3: Parallel port connector (CN4) .....	72

C.4	USB Connector (USB12, USB34, USB56, USB78) .....	72
	Table C.4: USB1/USB2 connector (USB12) .....	72
C.5	VGA Connector (VGA1) .....	73
	Table C.5: VGA connector (CN7).....	73
C.6	RS-232 Serial Port (COM1, COM2) .....	73
	Table C.6: RS-232 Serial Port (COM1, COM2) .....	73
C.7	PS/2 Keyboard/ Mouse Connector (KBMS1) .....	74
	Table C.7: PS/2 Keyboard/ Mouse connector (KBMS1) .....	74
C.8	External Keyboard Connector (KBMS2) .....	74
	Table C.8: External keyboard connector (KBMS2) .....	74
C.9	CPU Fan Power Connector (CPUFAN1) .....	75
	Table C.9: CPU Fan Power Connector (CPUFAN1).....	75
C.10	Power LED & Keyboard Lock Connector (JFP3) .....	75
	Table C.10: Power LED and keylock conn (JFP3).....	75
C.11	External Speaker Connector (JFP2/ SPEAKER) .....	76
	Table C.11:External Speaker Connector (JFP2/SPEAKER) .....	76
C.12	Reset Connector (JFP1/ RESET) .....	76
	Table C.12:Reset connector (JFP1/ RESET) .....	76
C.13	HDD LED Connector (JFP2/ HDDLED) .....	76
	Table C.13:HDD LED connector (JFP2/ HDDLED) .....	76
C.14	ATX Feature Connector (JATXF1) .....	77
	Table C.14:ATX feature connector (JATXF1) .....	77
C.15	ATX Soft Power Switch (JFP1/ PWR_SW)).....	77
	Table C.15:ATX soft power switch (JFP1/ PWR_SW).....	77
C.16	H/W Monitor Alarm (JOBS1).....	77
	Table C.16:H/W monitor alarm (JOBS1).....	77
C.17	AC-97 Audio Interface (AC-97) .....	78
	Table C.17:AC-97 Audio Interface (AC-97) .....	78
C.18	SM Bus Connector (JFP2/ SNMP) .....	78
	Table C.18:SM Bus Connector (JFP2/ SNMP) .....	78
C.19	Case Open Connector (JCASE) .....	78
	Table C.19:Case Open ConnectorJ (CASE).....	78
C.20	LAN1 and LAN2 connector (LANLED1) .....	79
	Table C.20:LAN1 and LAN2 connector (LANLED1) .....	79
C.21	GPIO Pin Header (GPIO1) .....	79
	Table C.21:GPIO pin header (GPIO1) .....	79
C.22	System I/O Ports .....	80
	Table C.22:System I/O ports.....	80
C.23	DMA Channel Assignments .....	81
	Table C.23:DMA channel assignments.....	81
C.24	Interrupt Assignments .....	81
	Table C.24:Interrupt assignments.....	81
C.25	1st MB Memory Map .....	82
	Table C.25:1st MB memory map .....	82
C.26	PCI Bus Map .....	82
	Table C.26:PCI bus map.....	82



# Chapter 1

Hardware  
Configuration

## 1.1 Introduction

The PCA-6008 is designed with the Intel 910GMLE chipset and ICH6M (I/O controller) to support the 400 MHz Front Side Bus, Intel Celeron M processor, with high speed/high capacity, dual channel DDRII 400 memory, and high performance I/O functions such as single Gigabit Ethernet port, Serial/Parallel ATA ports, and a PCI-Express host interface for LAN. In compliance with PICMG 1.0 specification, the PCA-6008 can be used with a wide choice of existing PCI/ISA backplanes to meet the versatile requirements of industrial applications.

The PCA-6008 is designed to deliver high performance for industrial applications. It uses Intel's long-life 910GMLE and ICH6M chipsets, and is equipped with an Intel Celeron M 600 MHz processor. It has 2 DIMM sockets in two separated memory channels. It accepts up to 2GB DDRII 400 SDRAM memory, enough for most applications. The PCA-6008 features single Gigabit Ethernet network interface(s). With the Realtek 8111B GbE controller designed-in, the PCA-6008 implements the PCI Express host interface (PCI-E X1) in LAN connections with a maximum throughput of 2Gbps for heavy-duty industrial network applications. The Intel 910GMLE integrated VGA controller provides superior 3D performance with the unique Intel Graphics Media Accelerator 900. Two Serial ATA ports (up to 150MB/s) allow the use of thin and long SATA cables for storage devices, eliminating cabling issues inside the industrial-grade chassis. In addition, the PCA-6008 also provides most of the popular I/O interfaces such as four USB 2.0 ports, AC-97 audio interface, 2 RS-232 ports, one enhanced parallel port and a floppy disk interface.

The PCA-6008 is designed with reliability considerations to suit industrial environments. To prevent CPU damage caused from overheating, the PCA-6008 features a thermal protection circuit that enables the processor to automatically shut down when the cooling system fails. A remote management port allows users to monitor the system health status and control the system remotely through standard SNMP/HTTP protocols when used with Advantech's SNMP-1000 Intelligent System Manager.

## 1.2 Features

- Supports 2 Serial-ATA devices
- Supports Dual Channel DDRII 400 SDRAM up to 2GB
- Features a thermal protection circuit which will enable the processor to automatically shut down when the cooling system fails.
- Onboard integrated VGA controller
- Supports 10/100/1000Base-T Ethernet
- 4 USB 2.0 ports
- CMOS automatic backup and restore to prevent accidental data loss of BIOS setup data
- Remote management with SNMP-1000-B1



## 1.3 Specifications

### 1.3.1 System

- **CPU:** Intel Celeron M 600 MHz, FSB 400 MHz. Advantech also certifies several high-performance CPU coolers as optional parts for customers who use high-speed CPUs in 2U chassis or high temperature environments.

- **L2 Cache:** CPU built-in, 512KB full-speed L2 cache

**BIOS:** Award Flash BIOS (4Mb Flash Memory)

- **System Chipset:** Intel 910GMLE with ICH6M
- **SATA/EIDE hard disk drive interface:** Two on-board serial ATA connectors with a data transmission rate of up to 150 MB/Sec and supporting Advanced Host controller interface (AHCI) technology. One IDE hard disk drive or two enhanced IDE devices. Supports PIO mode 4 (16.67MB/s data transfer rate) and ATA 33/66/100 (33/66/100MB/s data transfer rate). BIOS enabled/disabled.
- **Floppy disk drive interface:** Supports one floppy disk drive, 5¼" (360 KB and 1.2 MB) or 3½" (720 KB, 1.44 MB). BIOS enabled/disabled

### 1.3.2 Memory

- **RAM:** Up to 2GB in four 240-pin DIMM sockets. Supports dual channel DDRII 400 SDRAM.

### 1.3.3 Input/Output

- **Bus interface:** PICMG 1.0 compliant PCI/ISA bus interface
- **Enhanced parallel port:** Configurable to LPT1, LPT2, LPT3, or disabled. Standard DB-25 female connector provided. Supports EPP/SPP/ECP
- **Serial ports:** Two RS-232 ports with 16C550 UARTs (or compatible) with 16-byte FIFO buffer. Supports speeds up to 115.2 Kbps. Ports can be individually configured to COM1, COM2 or disabled
- **Keyboard and PS/2 mouse connector:** One 6-pin mini-DIN connector is located on the mounting bracket for easy connection to a keyboard or PS/2 mouse. An onboard keyboard pin header connector is available.
- **ISA bus:** Supports ISA without DMA. PCI-to-ISA bridge: ITE IT8888
- **AC-97 Audio:** PCA-6008 can provide audio function with the optional audio extension module PCA-AUDIO-00A1E
- **USB port:** Supports up to four USB 2.0 ports with the two USB 2.0 cable kits included, and supports transmission rates up to 480 Mbps; available through one 4-USB port cable kit, P/N:1700008461

### 1.3.4 VGA Interface

- **Controller:** Chipset integrated VGA controller
- **Display memory:** Dynamically shared system memory up to 128 MB.
- **Resolution:** Up to 2048x1536@ 85 Hz refresh

### 1.3.5 Ethernet LAN

- Supports single 10/100/1000Base-T Ethernet port(s) via PCI Express x1 bus which provides 500 MB/s data transmission rate.
- **Controller:**
- Single 10/100/1000Base-T: Realtek 8111B

**Note!** *The Speed & Duplex mode default setting is full duplex mode and can NOT be changed*



### 1.3.6 Industrial Features

- **Watchdog timer:** Can generate a system reset or IRQ11. The watchdog timer is programmable, with each unit equal to one second or one minute (255 levels). You can find programming details in Appendix A

### 1.3.7 Mechanical and Environmental Specifications

- **Operating temperature:** 0°~60° C (32° ~ 140° F, Depending on CPU)
- **Storage temperature:** -20°~ 70° C (-4° ~ 158° F)
- **Humidity:** 20 ~ 95% non-condensing
- **Power supply voltage:** +5 V, ±12 V
- **Power consumption:** Maximum: +5V: 3.66A, +12V: 0.56A (Intel Celeron M 600MHz with 400MHz FSB, 2x1G DDRII 533 SDRAM)
- **Board size:** 338 x 122 mm (13.3" x 4.8")
- **Board weight:** 0.5 kg (1.2 lb)

## 1.4 Jumpers and Connectors

Connectors on the PCA-6008 single board computer link it to external devices such as hard disk drives and a keyboard. In addition, the board has a number of jumpers used to configure the system for your application.

The tables below list the function of each of the board jumpers and connectors. Later sections in this chapter give instructions on setting jumpers. Chapter 2 gives instructions for connecting external devices to your single board computer.

**Table 1.1: Jumpers**

CMOS1	CMOS Clear
JWDT1	Watchdog timer output selection
JSETCOM2	COM2 RS-232/422/485 mode selector

**Table 1.2: Connectors**

Label	Function
IDE1	Primary IDE connector
FDD1	Floppy Drive connector
LPT1	Parallel port
VGA1	VGA1 VGA connector
COM1~2	Serial port: COM1~2 (9-pin connector)
KBMS1	PS/2 keyboard and mouse connector
KBMS2	External keyboard/mouse connector
ATX1	ATX 12V Auxiliary power connector (for CPU)
CPUFAN1	CPU1 fan connector
ATXF1	ATX feature connector
JFP1	Power and Reset Button connector
JFP2	HDD LED/SNMP SMBus/Speaker connector
JFP3	Power LED and keyboard lock connector
JIR	Infrared connector
JOBS1	HW Monitor Alarm Close: Enable OBS Alarm Open: Disable OBS Alarm
LAN1	Giga LAN RJ45 connector
SATA1~2	Serial ATA1~2
LANLED1	LAN1 and LAN2 LED connector
USB1~4	USB port pin headers
GPIO1	GPIO pin header (SMD pitch-2.0 mm)
JCASE1	Case open
CF1	CF socket

**Note!**  The 4-pin ATX 12V power connector "ATX1" must be connected to the power supply to provide adequate power to the CPU card. Otherwise, the system may become unstable.

# 1.5 Board Layout: Jumper and Connector Locations

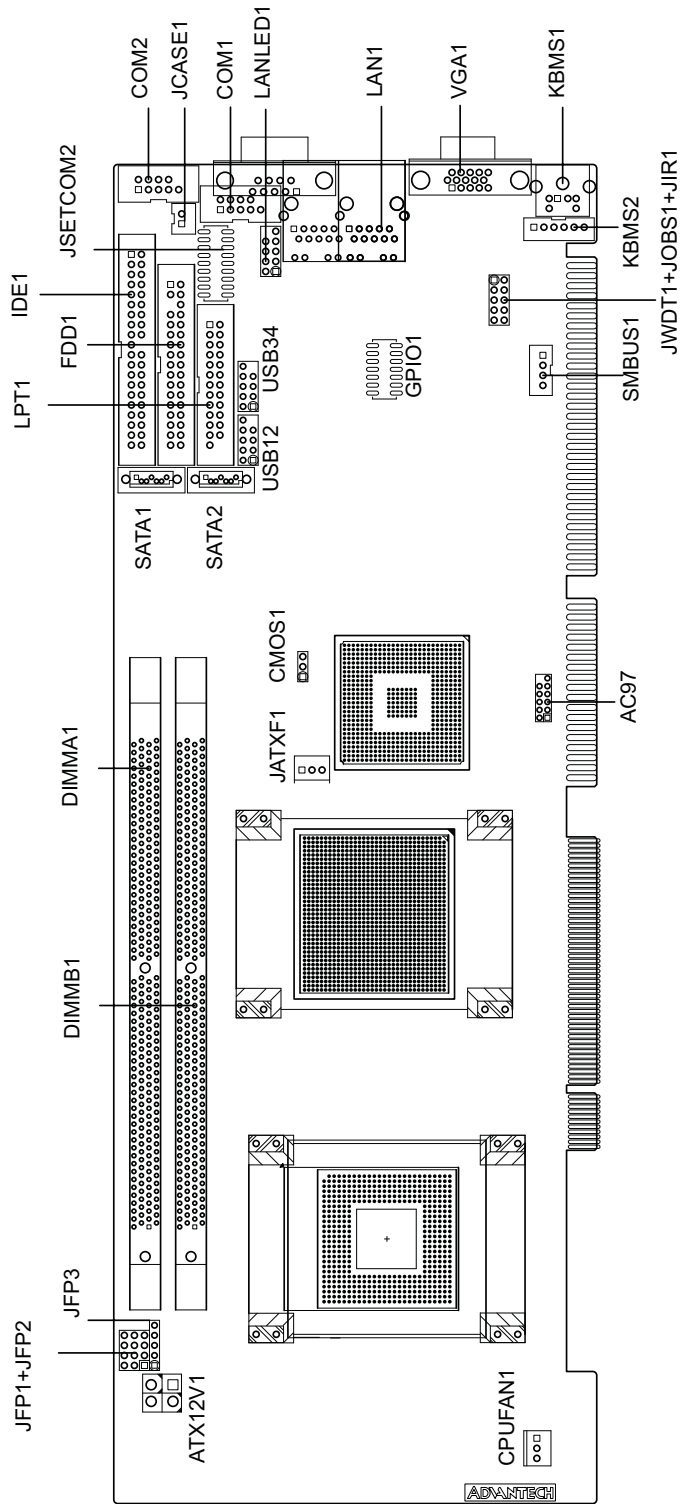

Figure 1.1: Jumper and Connector locations

## 1.6 PCA-6008 Block Diagram

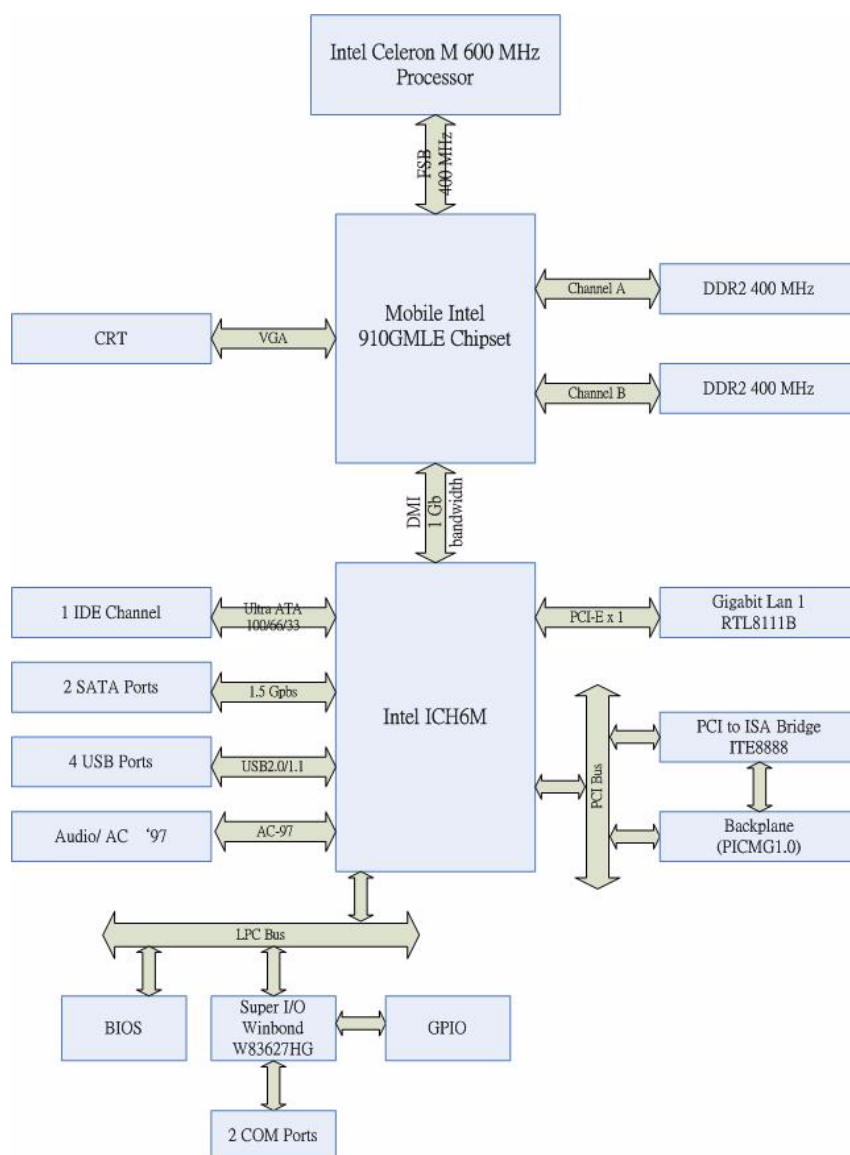

Figure 1.2: Block diagram

## 1.7 Safety Precautions

**Warning!** Always completely disconnect the power cord from your chassis whenever you work with the hardware. Do not make connections while the power is on. Sensitive electronic components can be damaged by sudden power surges. Only experienced electronics personnel should open the PC chassis.



**Caution!** Always ground yourself to remove any static charge before touching the single board computer. Modern electronic devices are very sensitive to static electric charges. As a safety precaution, use a grounding wrist strap at all times. Place all electronic components on a static-dissipative surface or in a static-shielded bag when they are not in the chassis.



**Caution!** *The computer is provided with a battery-powered Real-time Clock circuit. There is a danger of explosion if battery is incorrectly replaced. Replace only with same or equivalent type recommended by the manufacturer. Discard used batteries according to manufacturer's instructions.*



**Note!** *Before installing your PCA-6008 into a chassis, make sure that all components on both sides of the CPU card do not touch any metal parts, especially the chassis wall and add-on card at the adjacent slot*



## 1.8 Jumper Settings

This section provides instructions on how to configure your single board computer by setting the jumpers. It also includes the single board computer's default settings and options for each jumper.

### 1.8.1 How to Set Jumpers

You can configure your single board computer to match the needs of your application by setting the jumpers. A jumper is a metal bridge that closes an electrical circuit. It consists of two metal pins and a small metal clip (often protected by a plastic cover) that slides over the pins to connect them. To “close” (or turn ON) a jumper, you connect the pins with the clip. To “open” (or turn OFF) a jumper, you remove the clip. Sometimes a jumper consists of a set of three pins, labeled 1, 2, and 3. In this case you connect either pins 1 and 2, or 2 and 3. A pair of needle-nose pliers may be useful when setting jumpers.

### 1.8.2 CMOS Clear (CMOS1)

The PCA-6008 single board computer contains a jumper that can erase CMOS data and reset the system BIOS information. You can clear CMOS by shorting 2-3 pin while the system is off. Then return it to the 1-2 pin position. Avoid clearing the CMOS while the system is on; it will damage the mainboard.

**Table 1.3: CMOS1**

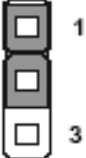
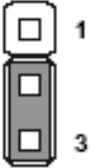
Voltage	Jumper Setting
* 3.3V	
5V	



\* default setting

### 1.8.3 Watchdog Timer Output (JWDT1)

The PCA-6008 contains a watchdog timer that will reset the CPU or send a signal to IRQ11 in the event the CPU stops processing. This feature means the PCA-6008 will

recover from a software failure or an EMI problem. The J2 jumper settings control the outcome of what the computer will do in the event the watchdog timer is tripped.

**Table 1.4: Watchdog timer output (JWDT1)**

Function	Jumper Setting
IRQ11	2  1-2 closed
* Reset	2  2-3 closed
* default setting	

**Note!** The interrupt output of the watchdog timer is a low level signal. It will be held low until the watchdog timer is reset



## 1.8.4 JSETCOM2 (RS232/422/485 Jumper Setting (JSETCOM2))

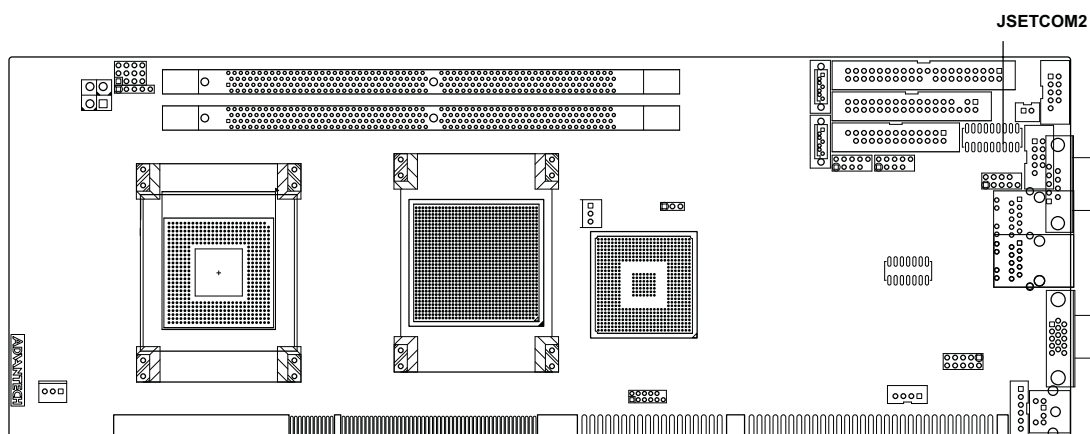

## 1.9 System Memory

The PCA-6008 has four sockets for 240-pin dual inline memory modules (DIMMs) in two separate memory channels. It can operate with single channel or dual channel modules. We recommend using dual channel mode to provide optimized performance.

All these sockets use 1.8 V unbuffered double data rate synchronous DRAMs (DDR II SDRAM). They are available in capacities of 256, 512 and 1024 MB. The sockets can be filled in any combination with DIMMs of any size, giving a total memory size between 256 MB and 2 GB.

## 1.9.1 CPU FSB and Memory Speed

The PCA-6008 can accept DDRII SDRAM memory chips without parity. Also note: The PCA-6008 accepts DDRII 400MHz SDRAM and DDRII 533MHz SDRAM, depending on the CPU front side bus frequency (FSB). Please refer to the table below for the relationship between the CPU FSB and memory speed.

## 1.9.2 Dual Channel Configuration

The 2 DIMM sockets are arranged in two channels: DIMM1 in channel A and DIMM2 in channel B.

It is suggested to use a "Matched pair of DIMMs" which means: same in speed (DDR266, DDR333, DDR400), same in size (128MB, 256MB, 512MB or 1GB), same in chip density (128 Mb, 256Mb or 512Mb and same in CSA latency. Any other memory configuration will result in single channel memory operation.

## 1.10 Memory Installation Procedures

To install DIMMs, first make sure the two handles of the DIMM socket are in the "open" position. i.e. The handles lean outward. Slowly slide the DIMM module along the plastic guides on both ends of the socket. Then press the DIMM module right down into the socket, until you hear a click. At this point the two handles have automatically locked the memory module into the correct position of the DIMM socket. To remove the memory module, just push both handles outward, and the memory module will be ejected by the mechanism in the socket.

## 1.11 Processor Installation

The CPU on the board must have a fan or heat sink attached, to prevent overheating.

**Warning!** *Without a fan or heat sink, the CPU will over-heat and cause damage to both the CPU and the single board computer. To install a CPU, first turn off your system and remove its cover. Locate the processor Socket 479*



1. The CPU has a plastic cap on it to protect the contact from damage. Before you install the CPU, always cover it to protect the socket pin. First, remove the cap from the lever hinge side and the pins of socket will be visible.
2. Open the load lever. Then, lift the load lever up and open the load plate. After confirming the CPU direction for correct mating, gently push the CPU down in the socket housing frame. Be sure to grasp on to the edge of the CPU base. Note that the alignment keys are matched.
3. Place the load plate onto the package. Press the load lever down lightly onto the load plate, and then secure the lever with the hook under retention tab. Confirm that your CPU cooler is firmly installed before turning on your system.



# Chapter 2

Connecting  
Peripherals

## 2.1 Introduction

You can access most of the connectors from the top of the board while it is installed in the chassis. If you have a number of cards installed or have a packed chassis, you may need to partially remove the card to make all the connections.

## 2.2 1st (IDE1) IDE Connector

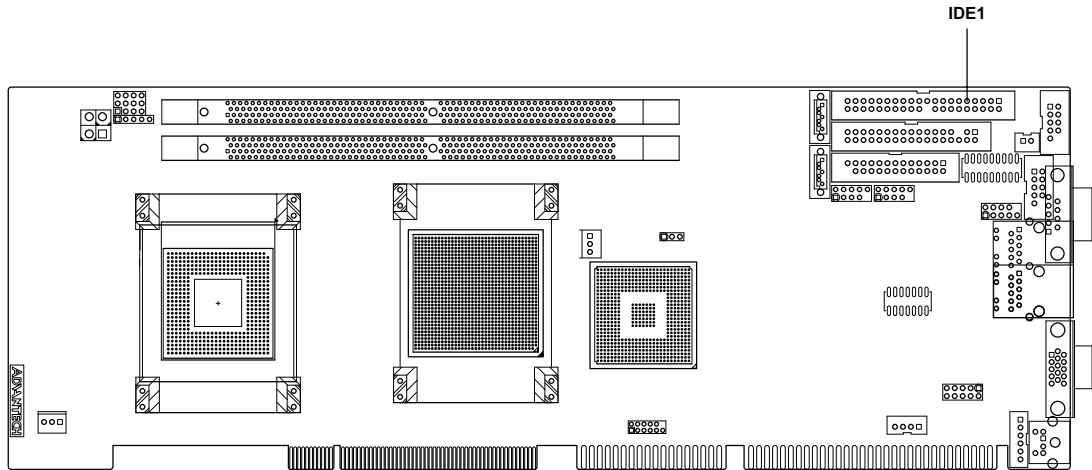

You can attach up to two IDE (Integrated Drive Electronics) drives to the PCA-6008's built-in controller. The primary (IDE1) connector can accommodate two drives.

Wire number 1 on the cable is red or blue and the other wires are gray. Connect one end to connector CN1 on the single board computer. Make sure that the red/blue wire corresponds to pin 1 on the connector (in the upper right hand corner). See Chapter 1 for help finding the connector.

Unlike floppy drives, IDE hard drives can connect in either position on the cable. If you install two drives to a single connector, you will need to set one as the master and the other as the slave. You do this by setting the jumpers on the drives.

Connect the first hard drive to the other end of the cable. Wire 1 on the cable should also connect to pin 1 on the hard drive connector, which is labeled on the drive circuit board. Check the documentation that came with the drive for more information.

## 2.3 Floppy Drive Connector (FDD1)

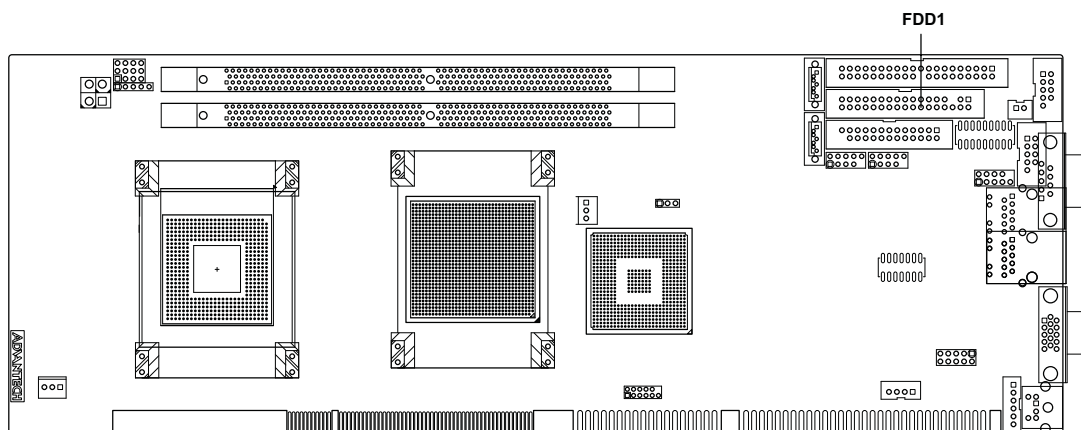

You can attach up to two floppy disk drives to the PCA-6008's on board controller. You can use 3.5" (720 KB, 1.44 MB) drives.

The single board computer comes with a 34-pin daisy-chain drive connector cable. On one end of the cable is a 34-pin flat-cable connector. On the other end are two sets of 34-pin flat-cable connectors (usually used for 3.5" drives). The set on the end (after the twist in the cable) connects to the A: floppy drive. The set in the middle connects to the B: floppy drive.

## 2.4 Parallel Port (LPT1)

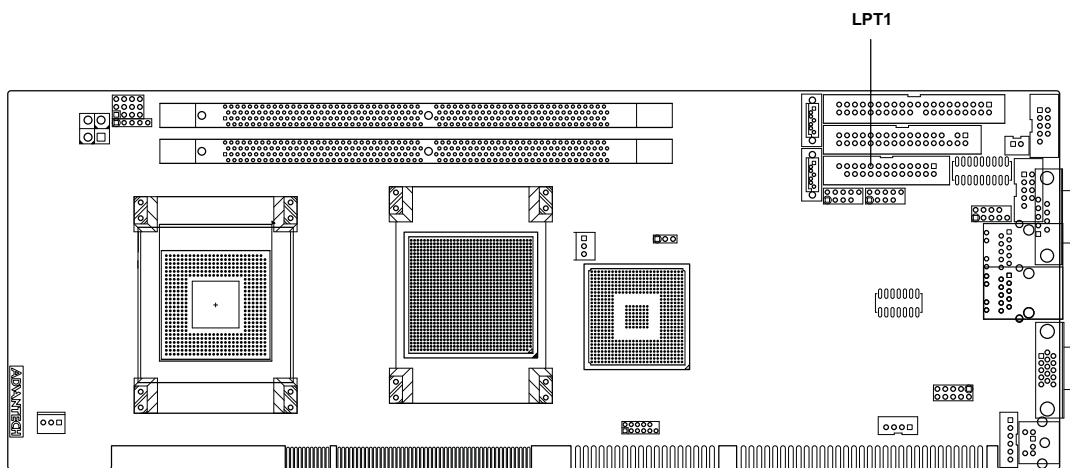

The parallel port is normally used to connect the single board computer to a printer. The PCA-6008 includes an onboard parallel port, LPT, accessed through a 26-pin flat-cable connector. The card comes with an adapter cable which lets you use a traditional DB-25 connector. The cable has a 26-pin connector on one end and a DB-25 connector on the other, mounted on a retaining bracket. The bracket installs at the end of an empty slot in your chassis, giving you access to the connector.

The parallel port is designated as LPT1, and can be disabled or changed to LPT2 or LPT3 in the system BIOS setup.

To install the bracket, find an empty slot in your chassis. Unscrew the plate that covers the end of the slot. Screw in the bracket in place of the plate. Next, attach the flat-cable connector to LPT1 on the CPU card. Wire 1 of the cable is red or blue, and the other wires are gray. Make sure that wire 1 corresponds to pin 1 of LPT1. Pin 1 is on the upper right side of LPT1.

## 2.5 USB Ports (USB12, USB34)

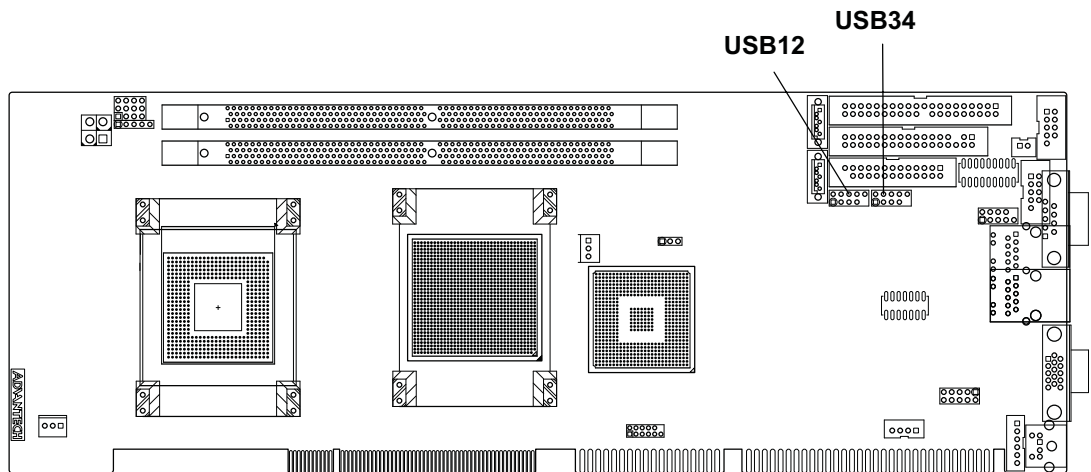

The PCA-6008 provides up to four USB (Universal Serial Bus) interface ports. The USB interface complies with USB Specification Rev. 2.0 which supports transmission rates up to 480 Mbps and is fuse-protected. The USB interface can be disabled in the system BIOS setup. To install the USB cable bracket (p/n:1700008461), find an empty slot in your chassis. Unscrew the plate that covers at the end of the slot. Screw in the bracket in place of the plate. Next, attach the USB connector to the USB12, USB34 slots.

## 2.6 VGA Connector (VGA1)

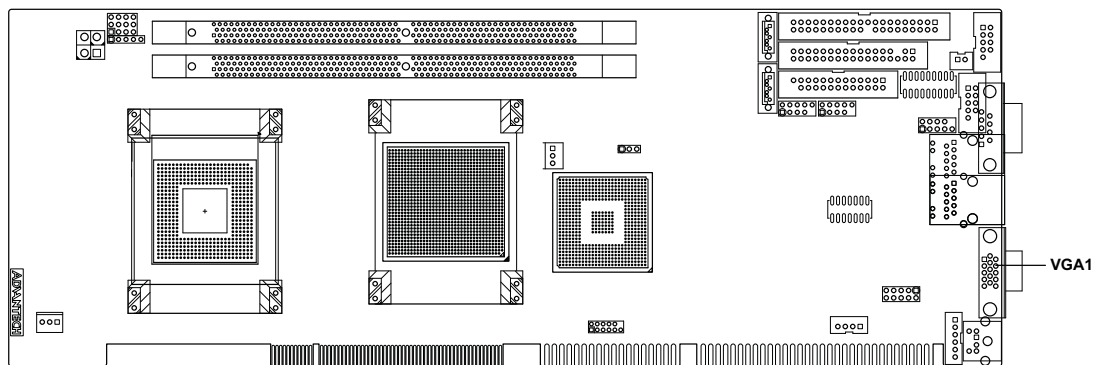

The PCA-6008 includes a VGA interface that can drive conventional CRT displays. VGA1 is a standard 15-pin D-SUB connector commonly used for VGA. Pin assignments for the CRT connector VGA1 are detailed in Appendix B.

## 2.7 Ethernet Connector (LAN1)

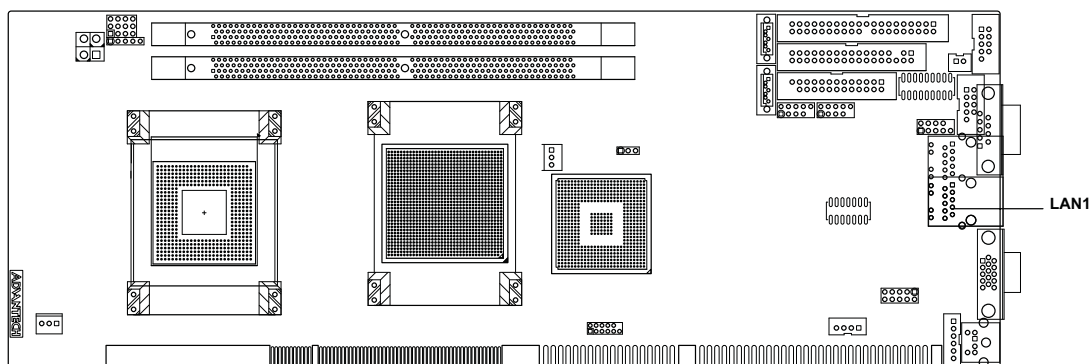

The PCA-6008 is equipped with a single high performance 1000 Base-T Ethernet interface. The Gigabit Ethernet port uses the Realtek RTL8111B controller connected to the PCI-Express x1 of the ICH6 I/O controller. The PCA-6008 is fully compliant with IEEE 802.3ab 1000Base-T standards. It is supported by all major network operating systems and is 100% Novell NE-2000 compatible. An onboard RJ-45 jack provides convenient 10/100/1000Base-T RJ-45 operation.

## 2.8 Serial Ports (COM1, COM2)

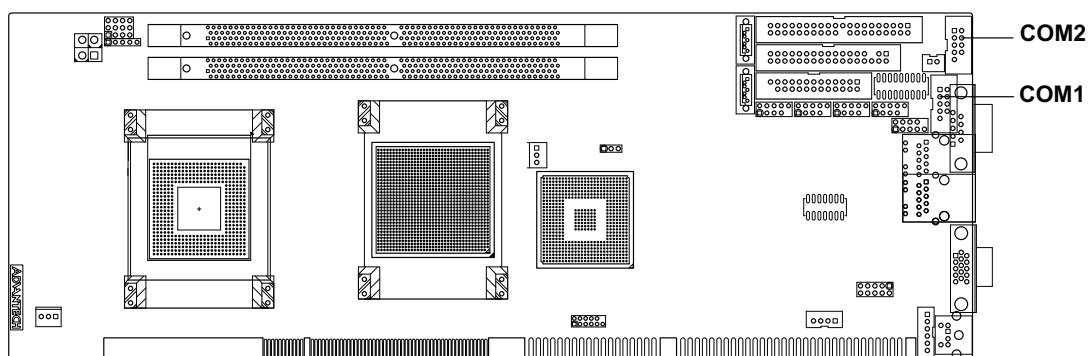

The PCA-6008 offers up to two serial ports. These ports can connect to serial devices, such as a mouse or a printer, or to a communications network.

The IRQ and address ranges for those ports are fixed. However, if you want to disable the port or change these parameters later, you can do this in the system BIOS setup.

Different devices implement the RS-232 standard in different ways. If you are having problems with a serial device, be sure to check the pin assignments for the connector.

## 2.9 PS/2 Keyboard/Mouse Connector (KBMS1)

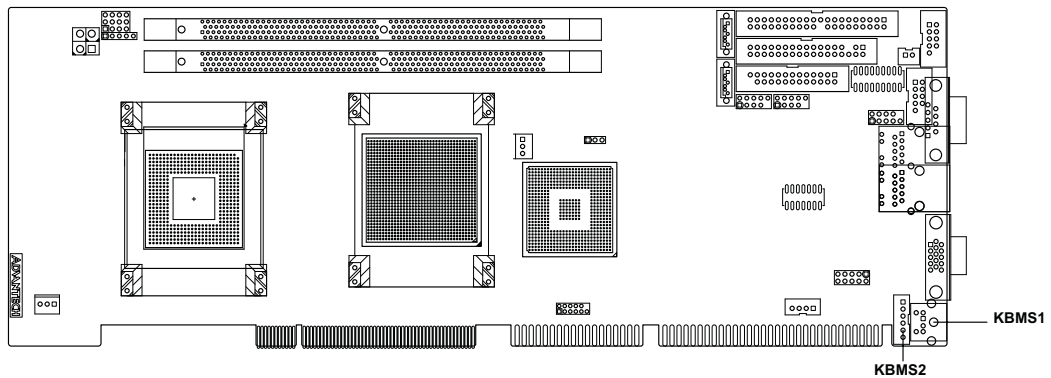

One 6-pin mini-DIN connector (KBMS1) on the card mounting bracket provides connection to a PS/2 keyboard or a PS/2 mouse, respectively. The KBMS1 connector can also be connected to an adapter cable (P/N: 1700060202, available from Advantech) for connecting to both a PS/2 keyboard and a PS/2 mouse.

## 2.10 External Keyboard Connector (KBMS2)

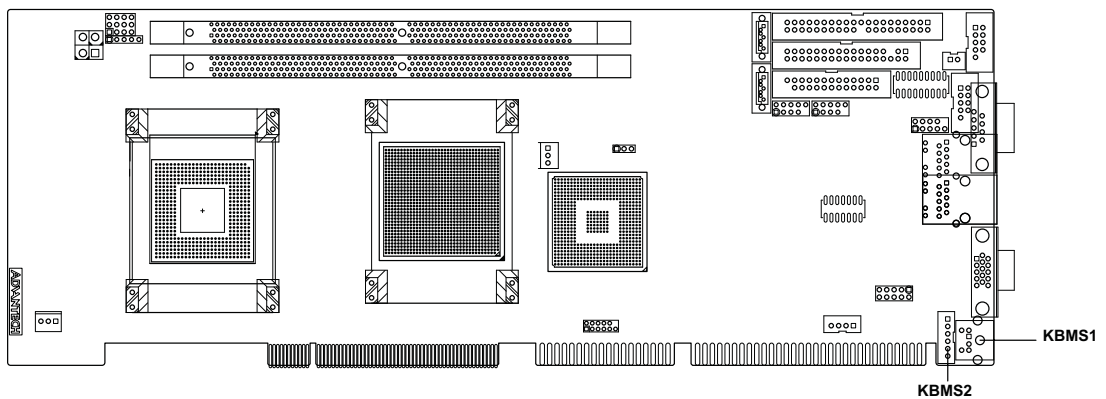

In addition to the PS/2 mouse/keyboard connector on the PCA-6008's rear plate, there is also an extra onboard external keyboard connector. This gives system integrators greater flexibility in designing their systems.

## 2.11 CPU Fan Connector (CPUFAN1)

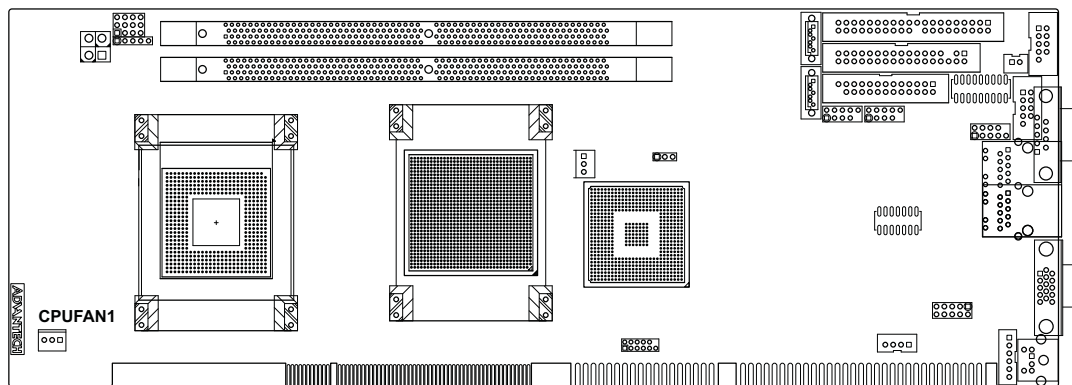

The PCA-6008 provides a 4 pin CPU fan connector.

## 2.12 Front Panel Connectors (JFP1, JFP2, JFP3)

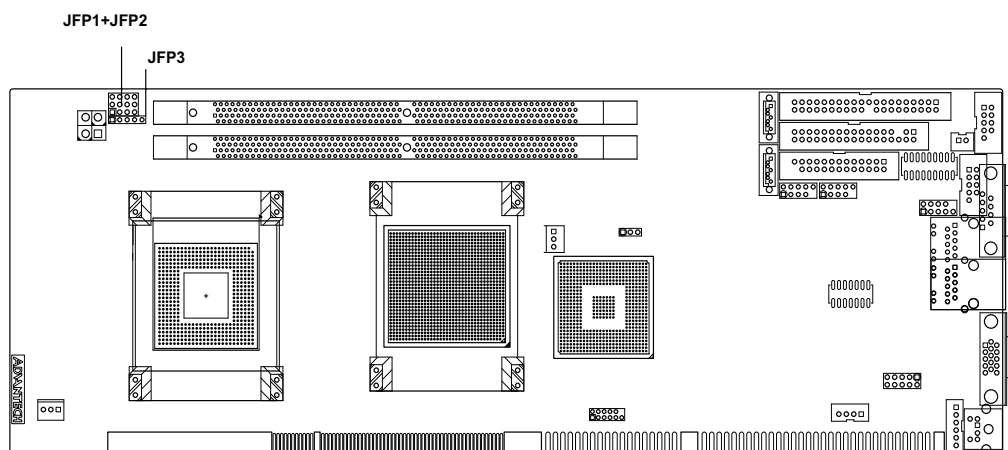

There are several external switches to monitor and control the PCA-6008.

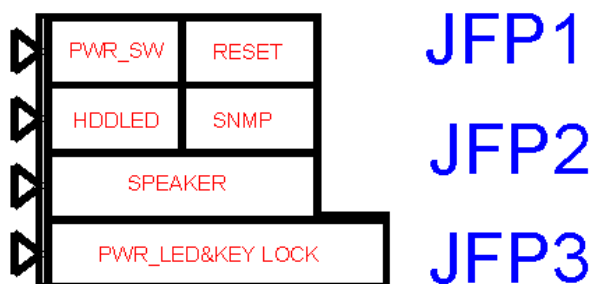

### 2.12.1 ATX Soft Power Switch (JFP1 / PWR\_SW)

If your computer case is equipped with an ATX power supply, you should connect the power on/off button on your computer case to (JFP1 / PWR\_SW). This connection enables you to turn your computer on and off.

### 2.12.2 Reset (JFP1 / RESET)

Many computer cases offer the convenience of a reset button. Connect the wire for the reset button.

### 2.12.3 HDD LED (JFP2 / HDDLED)

You can connect an LED to connector (JFP2 / HDDLED) to indicate when the HDD is active.

### 2.12.4 SM Bus Connector (JFP2 / SNMP)

This connector is reserved for Advantech's SNMP-1000 HTTP/SNMP Remote System Manager. The SNMP-1000 allows users to monitor the internal voltages, temperature and fans from a remote computer through an Ethernet network.

(JFP2 / SNMP) can be connected to CN19 of SNMP-1000. Please be careful about the pin assignments, pin 1 must be connected to pin 1 and pin 2 to pin 2 on both ends of the cable.

### 2.12.5 External Speaker (JFP2 / SPEAKER)

(JFP2 / SPEAKER) is a 4-pin connector for an external speaker. If there is no external speaker, the PCA-6008 provides an onboard buzzer as an alternative. To enable the buzzer, set pins 3-4 closed.

### 2.12.6 Power LED and Keyboard Lock Connector (JFP3 / PWR\_LED&KEY LOCK)

(JFP3 / PWR\_LED&KEY LOCK) is a 5-pin connector for the power on LED and Key Lock function. Refer to Appendix B for detailed information on the pin assignments. The Power LED cable should be connected to pins 1-3. The key lock button cable should be connected to pins 4-5.

There are 3 modes for the power supply connection. The first is "ATX power mode"; the system is turned on/off by a tentative power button. The second is "AT Power Mode"; the system is turned on/off by the power supply switch. The third is another "AT Power Mode" which is using the front panel power switch. The power LED status is indicated in the following table:

**Table 2.1: ATX power supply LED status (No support for AT power)**

Powermode	LED (ATX Power Mode) (On/off by tentative button)	LED (AT Power Mode) (On/off by switching power supply)	LED (AT Power Mode) (On/off by front panel switch)
PSON1 (On Back plane) Jumper setting	2-3 pin closed	1-2 pin closed	Connect 1-2 pin cable with switch
System On	On	On	On
System Suspend	Fast flashes	Fast flashes	Fast flashes
System Off	Slow flashes	Off	Off



## 2.13 ATX Feature Connector (JATXF1)

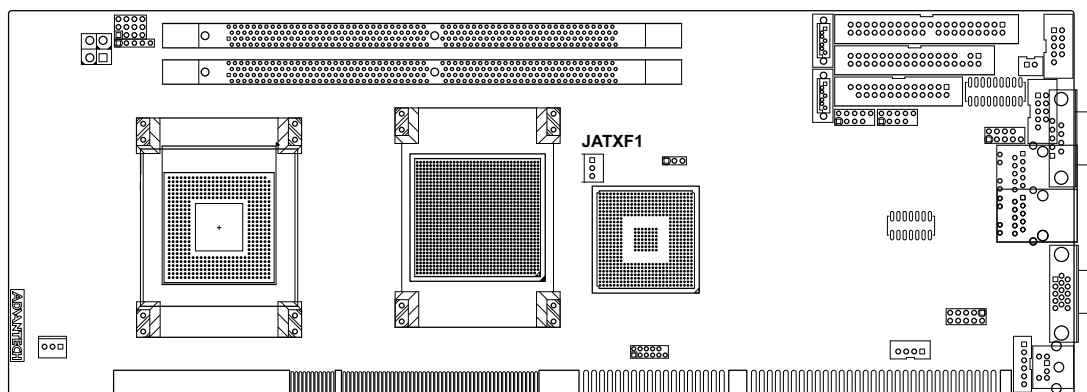

Connect to the JATXF1 connector on the Advantech backplane to enable the ATX function, 5V stand-by.

## 2.14 AC-97 Audio Interface (AC-97)

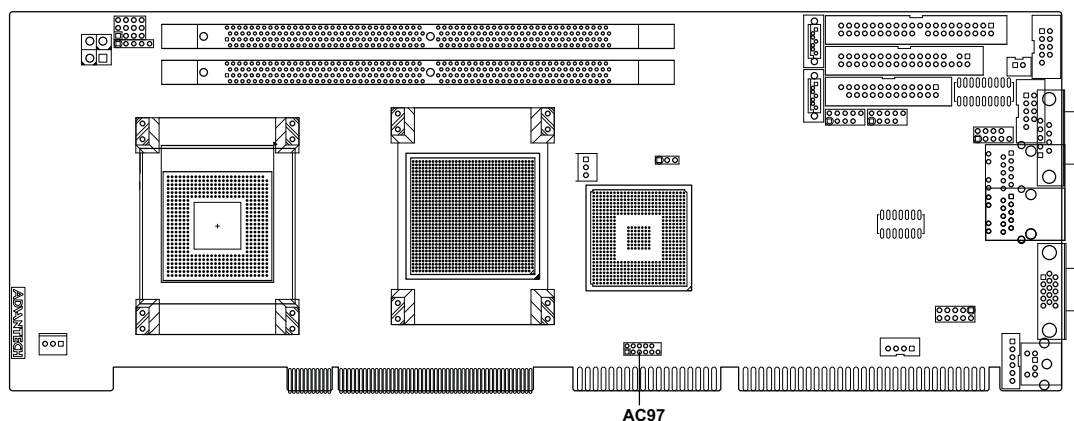

The PCA-6008 provides AC-97 audio through the PCA-AUDIO-00A1E module from Advantech.

## 2.15 Serial ATA Interface (SATA1, SATA2)

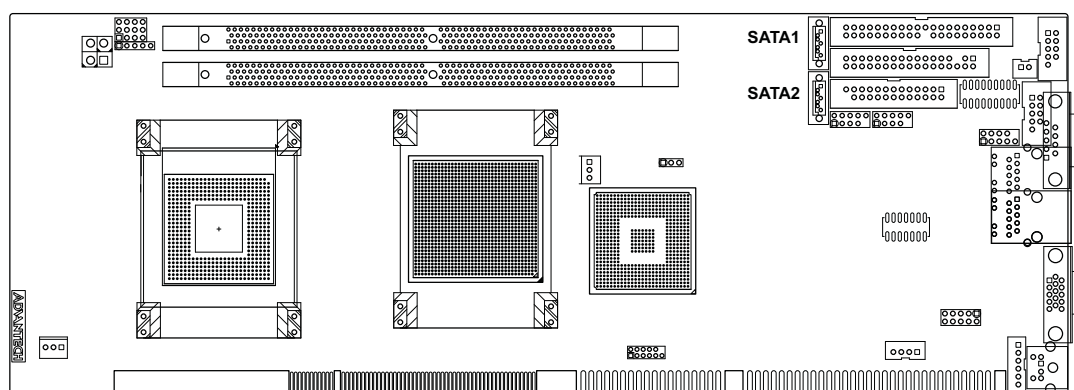

In addition to the one EIDE interface (up to two devices), the PCA-6008 provides four high performance serial ATA interfaces (up to 150MB/s) which eases cabling to hard drives with thin and long cables.

**Note!** Please into BIOS to adjust the "On-Chip Series ATA to enhanced mode" when install SATA and IDE device at the same time.



## 2.16 Auxiliary 4-pin Power Connector (ATX12V1)

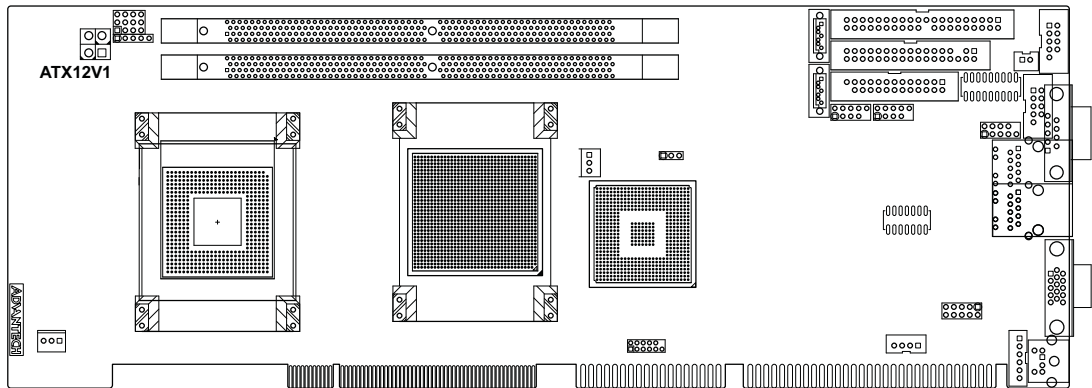

To ensure a sufficient power supply for the Pentium® 4 single board computer, one auxiliary 4-pin power connector is available on the PCA-6008. This connector must be connected to the power supply, otherwise the system may become unstable.

## 2.17 Hardware Monitor Alarm (JWDT1+JOBS1+JIR1)

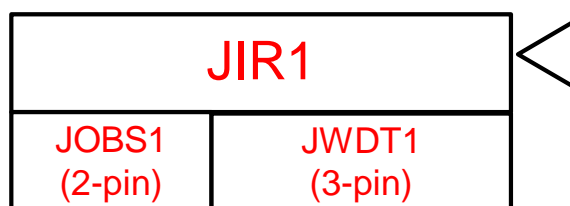
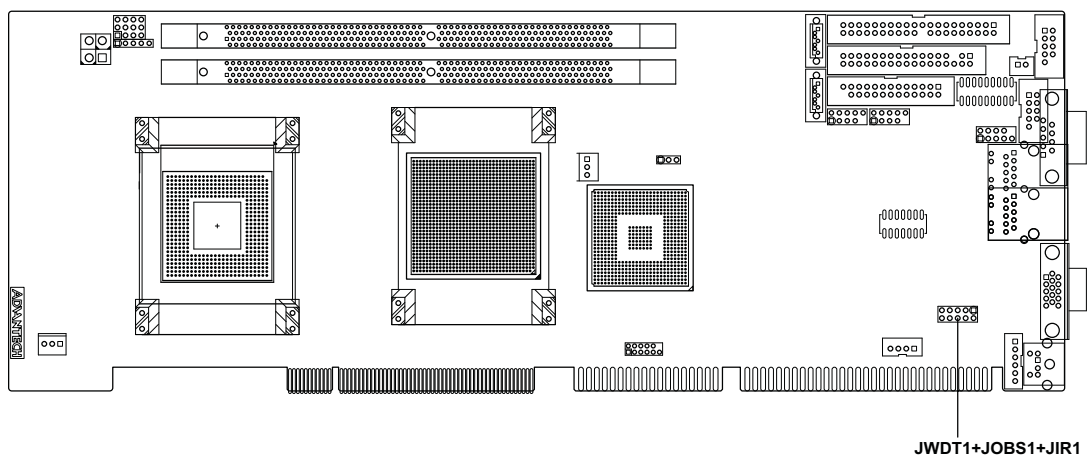

JWDT1 is a 3-pin jumper. For detailed settings please refer to 1.8.3 Watchdog Timer Output.

JOBS1 is a 2-pin connector for setting the enable/ disable alarm for on board security events.

JIR1 supports the optional wireless infrared transmitting and receiving module. This module mounts on the system case. You must configure the setting through the BIOS setup.

**Table 2.2: Hardware Monitor Alarm (JOBS1) setting**

Pin setting	Function
Close	Enable OBS alarm
Open	Disable OBS alarm

## 2.18 Case Open Connector (JCASE1)

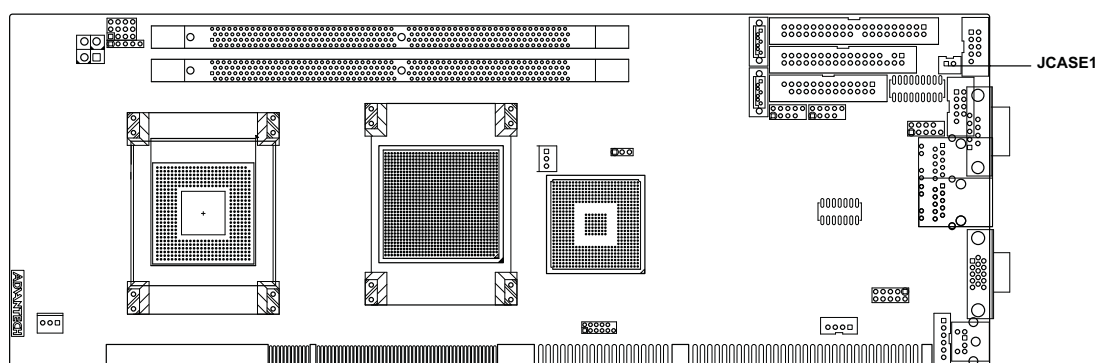

The signal is connected to the limit switch sensor of the chassis to detect if the case open or closed.

## 2.19 LAN1LED (LANLED1)

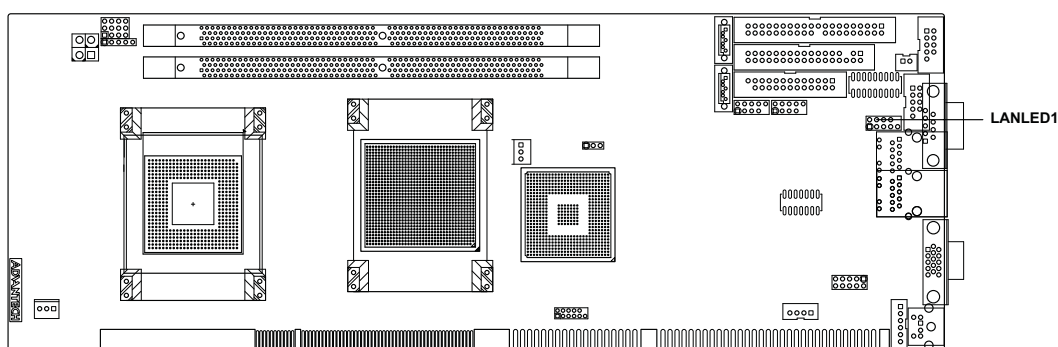

The PCA-6008 provides an external LAN LED pin header for connecting to the front side of the chassis. With this convenient design, users can know whether or not the LAN port is active. Refer to Appendix B for detailed information on pin assignments.

## 2.20 GPIO Pin Header (GPI01)

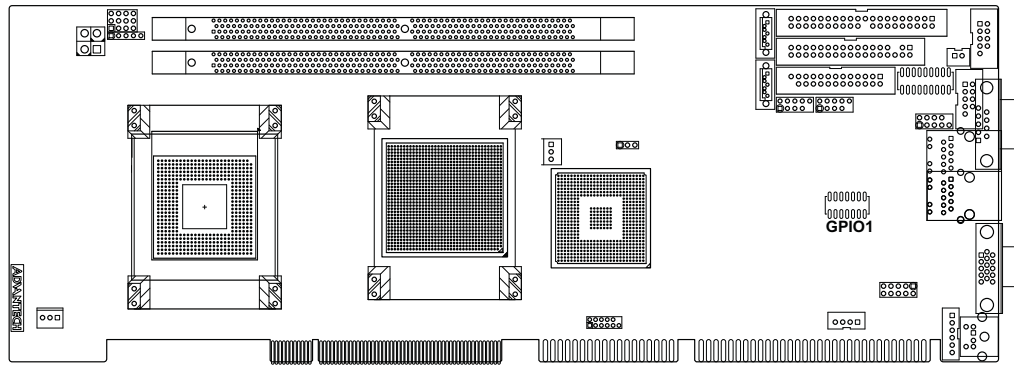

The PCA-6008 specifically has a 14-pin General Purpose I/O interface for port 80 functions used in detecting hardware bugs or for programmable 8-bit I/O.

# Chapter 3

Award BIOS Setup

## 3.1 Introduction

Award's BIOS ROM has a built-in setup program that allows users to modify the basic system configuration. This type of information is stored in battery backed-up memory (CMOS RAM) so that it retains the setup information when the power is turned off.

### 3.1.1 CMOS RAM Auto-backup and Restore

The CMOS RAM is powered by an onboard button cell battery. When you finish BIOS setup, the data in CMOS RAM will be automatically backed up to Flash ROM. If operation in harsh industrial environments causes a soft error, BIOS will recheck the data in CMOS RAM and automatically restore the original data in Flash ROM to CMOS RAM for booting.

**Note!** *If you intend to change the CMOS setting without restoring the previous backup, you have to click on "DEL" within two seconds of the "CMOS checksum error..." display screen message appearing. Then enter the "Setup" screen to modify the data. If the "CMOS checksum error..." message appears over and over, please check to see if you need to replace the battery in your system.*



## 3.2 Entering Setup

Turn on the computer and press <Del> to enter the BIOS setup.

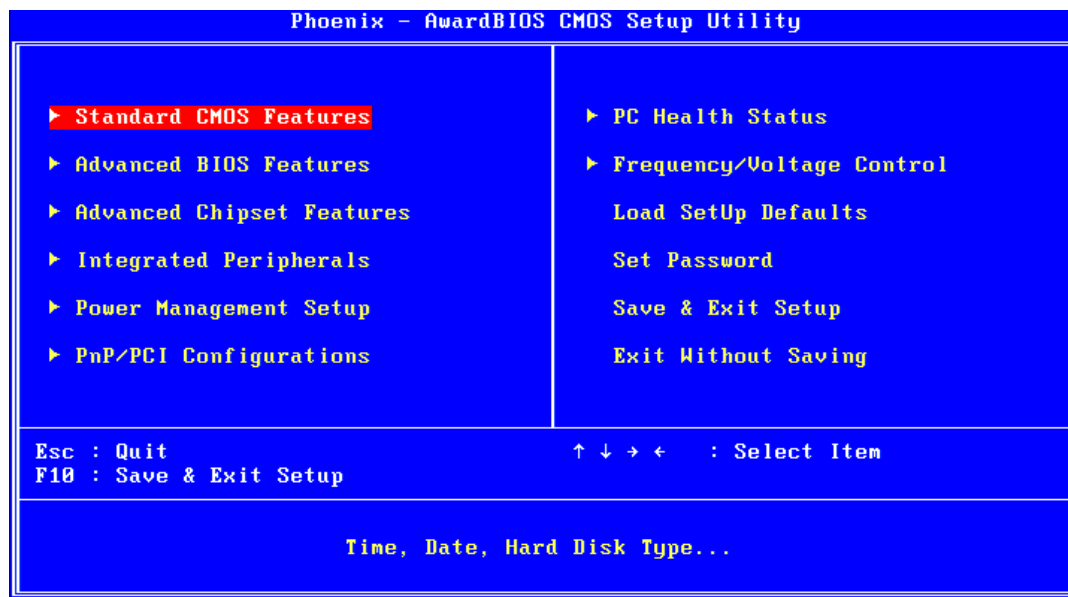

Figure 3.1 Award BIOS Setup initial screen

## 3.3 Standard CMOS Setup

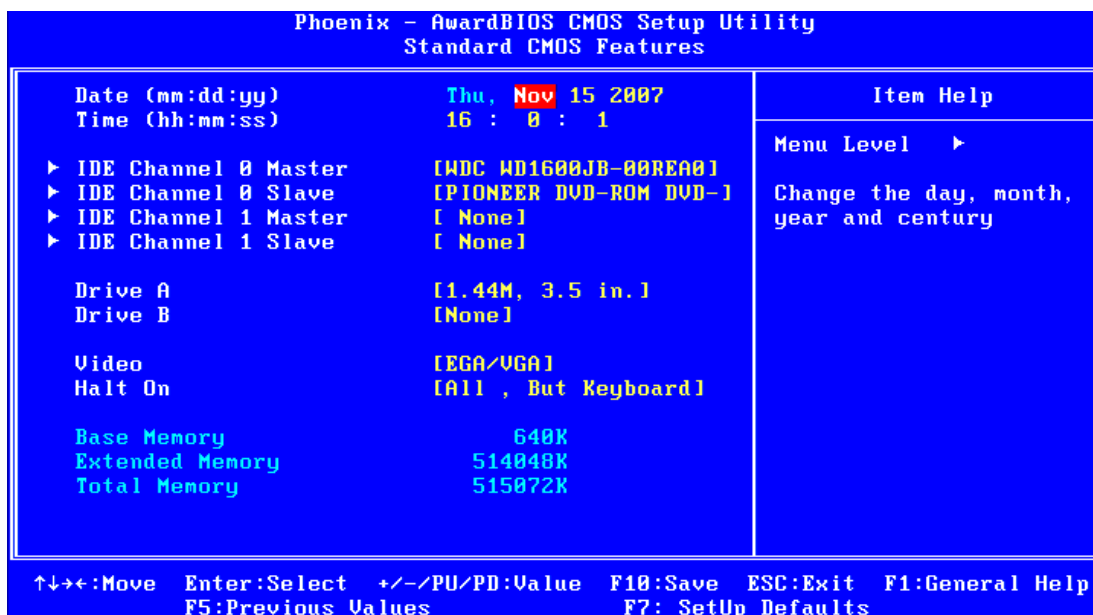

Figure 3.2 Standard CMOS Features Screen

### 3.3.1 Date

The Date Format is <Week>, <Month>, <Day>, <Year>.

### 3.3.2 Time

The times format is <hours> <minutes> <seconds>, based on 24-hour military time .

### 3.3.3 IDE Channel 0/1 Master/Slave

- IDE HDD Auto-Detection:
  - Press "Enter" to select this option for automatic device detection.
- IDE Device Setup.
  - Auto: Automatically detect IDE devices during POST
  - None: Select this when no IDE device is used and the system will skip the auto-detection step to make system start up faster.
  - Manual: User can manually input the correct settings.
- Access Mode: The options are CHS/LBA/Large/Auto
- Capacity of currently installed hard disk.
- Cylinders: Number of cylinders
- Heads: Number of heads
- Precomp: Write precomp
- Landing Zone: Landing zone
- Sector: Number of sectors

### 3.3.4 Drive A / Drive B

This category identifies the types of floppy disk drives installed in the system. The options are: None/360K, 5.25"/1.2M, 5.25"/720K, 3.5"/1.44M, 3.5"/2.88M, 3.5".

### 3.3.5 Halt On

This category determines whether the system will halt or not on start-up when an error is detected during power up.

The options are: No Errors/ All Errors/ All, But Keyboard/ All, But Diskette/ All, But Disk/Key

### 3.3.6 Memory

The category displays base memory, extended memory and total memory detected during POST (Power On Self Test).

## 3.4 Advanced BIOS Features

The “Advanced BIOS Features” screen appears when choosing the “Advanced BIOS Features” item from the “Initial Setup Screen” menu. It allows the user to configure the PCA-6008 according to his particular requirements. Below are some major items that are provided in the Advanced BIOS Features screen. A quick booting function is provided for your convenience. Simply enable the Quick Booting item to save yourself valuable time.

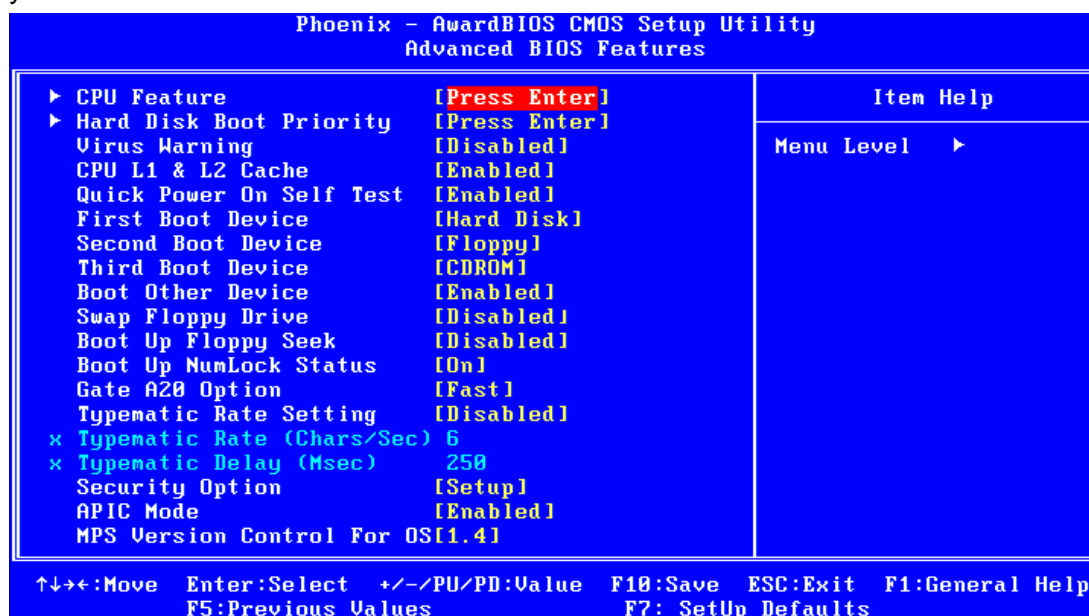

Figure 3.3 Advanced BIOS features screen

### 3.4.1 CPU Features

Delay Prior to thermal

This feature controls the activation of the Thermal Monitor's automatic mode. It allows you to determine when the Pentium 4's Thermal Monitor should be activated in automatic mode after the system boots. For example, with the default value of 16 Minutes, the BIOS activates the Thermal Monitor in automatic mode 16 minutes after the system starts booting up. The choices are 4 Min, 8 Min, 16 Min, and 32 Min.

Limit CPUID MaxVal

Set Limit CPUID MaxVa1 to 3, should be Disabled for WinXP.

Execute Disable Bit

When disabled, forces the XD feature flag to always return 0.



### 3.4.2 Hard Disk Boot Priority

Set hard disk boot device priority.

### 3.4.3 Virus Warning

Enable virus warning, the commands are "Enabled" or "Disabled".

### 3.4.4 CPU L1 & L2 Cache

Enabling this feature speeds up memory access. The commands are "Enabled" or "Disabled."

### 3.4.5 Quick Power On Self Test

It allows the system to skip certain tests to speed up boot-up procedure.

### 3.4.6 First/Second/Third Boot Device

The BIOS tries to load the OS from the devices in the sequence set here. The options are: "Floppy", "LS120", "HDD-0", "SCSI", "CDROM", "HDD-1", "HDD-2", "HDD-3", "ZIP100", "USB-FDD", "USB-ZIP", "USBCDROM", "USB-HDD", "LAN", "Disabled".

### 3.4.7 Boot Other Device

To boot another device, the options are "Enabled" and "Disabled".

### 3.4.8 Swap Floppy Drive

If the system has two floppy drives, choose "Enabled" to assign physical drive B to logical drive A and vice-versa. The commands are "Enabled" or "Disabled."

### 3.4.9 Boot Up Floppy Seek

Selection of the command "Disabled" will speed the boot up. Selection of "Enabled" searches disk drives during boot up.

### 3.4.10 Boot Up NumLock Status

Set the boot up status Num Lock, the options are "On" and "Off".

### 3.4.11 Gate A20 Option

"Normal": A pin in the keyboard controller controls GateA20. Fast" (Default): Lets chipset control GateA20.

### 3.4.12 Typematic Rate Setting

The typematic rate is the rate key strokes repeat as determined by the keyboard controller. The commands are "Enabled" or "Disabled." Enabling allows the typematic rate and delay to be selected.

### 3.4.13 Typematic Rate (Chars/Sec)

BIOS accepts the following input values (characters/second) for typematic rate: 6, 8, 10, 12, 15, 20, 24, 30.

### 3.4.14 Typematic Delay (msec)

Typematic delay is the time interval between the appearances of two consecutive characters, when the key is continuously depressed. The input values for this category are: 250, 500, 750, and 1000 (ms).

### 3.4.15 Security Option

This category determines whether the password is required when the system boots up or only when entering setup. The options are:

"System" The system will not boot, and access to Setup will be also denied unless the correct password is entered at the prompt.

"Setup" The system will boot, but access to Setup will be denied unless the correct password is entered at the prompt.

**Note!** *To disable security, select PASSWORD SETTING in the main menu. Then, you will be asked to enter a password. Simply press <Enter> to disable security. When security is disabled, the system will boot and you can enter Setup freely*



### 3.4.16 APIC Mode

This setting allows you to enable the APIC mode, the choice is "Disabled" or "Enabled."

### 3.4.17 MPS Version Control For OS

The selections are "1.1" or "1.4" MPS 1.1 is the original specification. MPS version 1.4 adds extended configuration tables for improved support of multiple PCI bus configurations and greater expandability in the future. In addition, MPS 1.4 introduces support for a secondary PCI bus without requiring a PCI bridge .



---

DRAM refresh, refreshing may be incomplete and DRAM may fail to retain data. This item applies only when synchronous DRAM is installed in the system. Setting options: [2T] to [5T], [Auto].

### 3.5.5 Precharge Delay (t RAS)

This item allows you to select the value in this field, depending on whether the board has paged DRAMs or EDO (extended data output) DRAMs. The choices are: "4" to "15" and "Auto."

### 3.5.6 System Memory Frequency

To adjust the frequency of memory. The choices are: "400MHz," "533MHz" and "Auto."

### 3.5.7 System BIOS Cacheable

Selecting "Enabled" allows caching of the system BIOS ROM at F0000h-FFFFFh, resulting in better system performance. However, if any program writes data to this memory area, a system error may occur. The Choices: "Enabled," "Disabled."

### 3.5.8 Video BIOS Cacheable

Selecting "Enabled" allows caching of the video BIOS, resulting in better system performance. However, if any program writes to this memory area, a system error may occur. The Choices: "Enabled," "Disabled."

### 3.5.9 Memory Hole At 15M-16M

Enabling this feature reserves 15 MB to 16 MB memory address space for ISA expansion cards that specifically require this setting. This makes memory from 15 MB and up unavailable to the system. Expansion cards can only access memory up to 16 MB. The default setting is "Disabled."

### 3.5.10 PCI-Express Root Port Func

PCI Express Port 1/2/3/4

The default setting is "Auto." The choices are "Enabled," "Disabled," and "Auto."

PCI-E Compliancy Mode

It allows user to select the PCI-E compliant mode. Setting options: [v1.0], [v1.0a].

### 3.5.11 On-Chip Frame Buffer Size

The On-Chip Frame Buffer Size can be set us 1 MB or 8 MB. This memory is shared with the system memory.

### 3.5.12 DVMT Mode

This option shows the active system memory mode.

### 3.5.13 DVMT/ FIXED Memory Size

Specify the size of DVMT and system memory to allocate for video memory.

### 3.5.14 Boot Display

You can select the display type for your computer equipment. Choices for this option include: VBIOS Default, CRT, LFP, CRT+LFP, EFP, and CRT+EFP. EEP can be used for LCD displays.

### 3.5.15 Init Display First

Choose the first display interface to initiate while booting. The choice is "PCI Slot" or "Onboard."

## 3.6 Integrated Peripherals

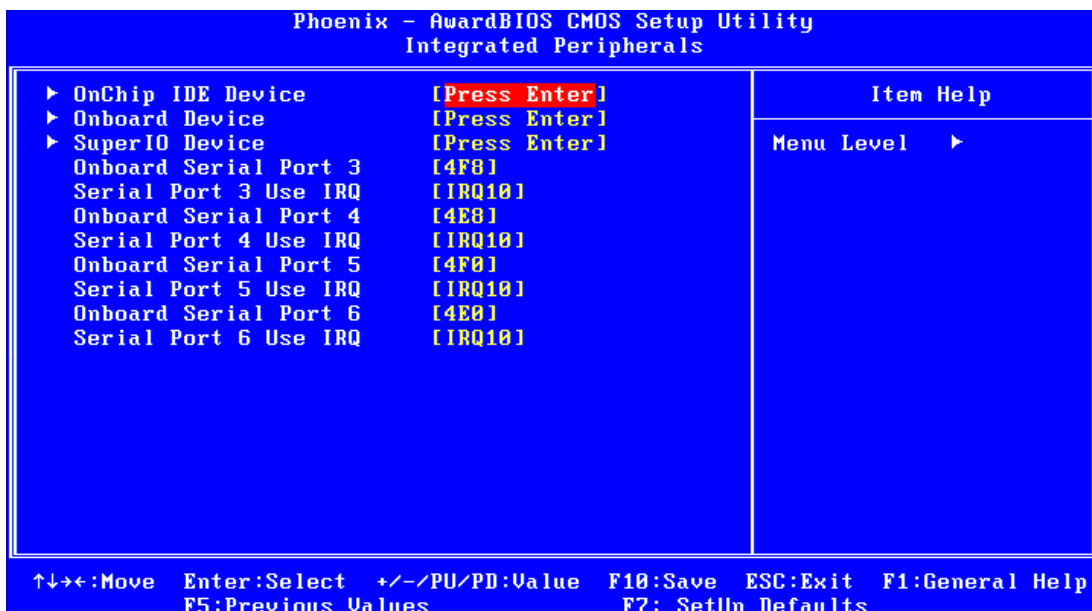

Figure 3.5 Integrated peripherals

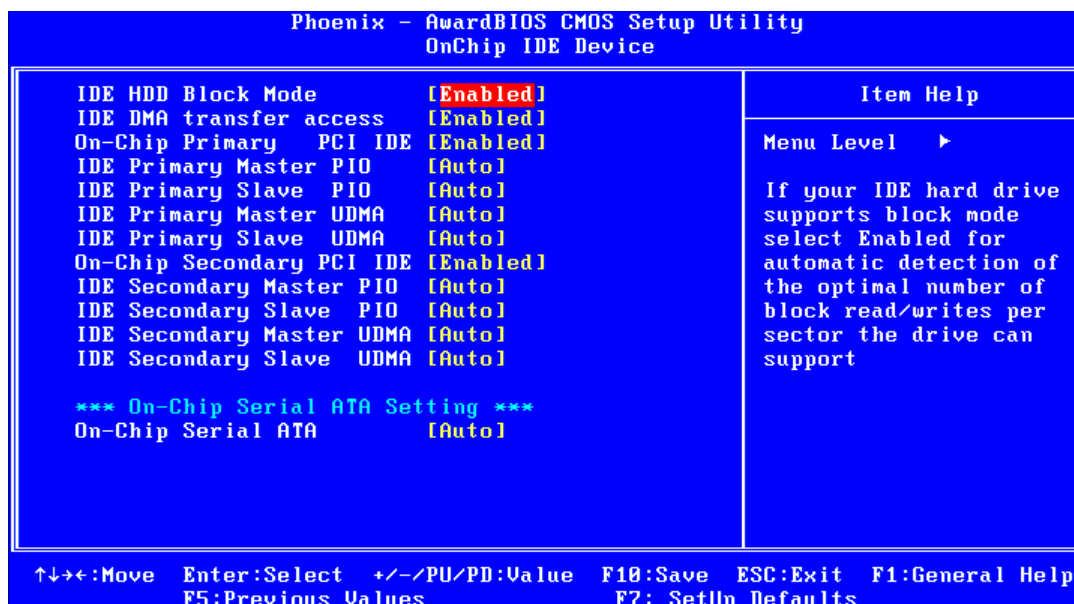

Figure 3.6 On-Chip IDE Device

### 3.6.1 IDE HDD Block Mode

If your IDE hard drive supports block mode select Enabled for automatic detection of the optimal number of block read/writes per sector the drive can support.

### 3.6.2 IDE DMA Transfer Access

Use this field to enable or disable IDE DMA transfer access.

### 3.6.3 On-Chip IDE Device

IDE Primary Master/Slave PIO/UDMA Mode (Auto). The channel has both a master and a slave, making four IDE devices possible. Because two IDE devices may have a different Mode timing (0, 1, 2, 3, 4), it is necessary for these to be independent. The default setting "Auto" will allow auto detection to ensure optimal performance.

### 3.6.4 On-Chip Serial ATA

Choose the status of serial ATA, the default setting is "Auto" which let system to arrange all parallel and serial ATA resource automatically. The "Disabled" will disable SATA controller. The "Combined Mode" will combine PATA and SATA, and max of 2 IDE drives in each channel. The "Enhanced Mode" will enable both SATA and PATA, and maxes of 4 IDE drives are supported. The "SATA Only" means SATA is operating in legacy mode.

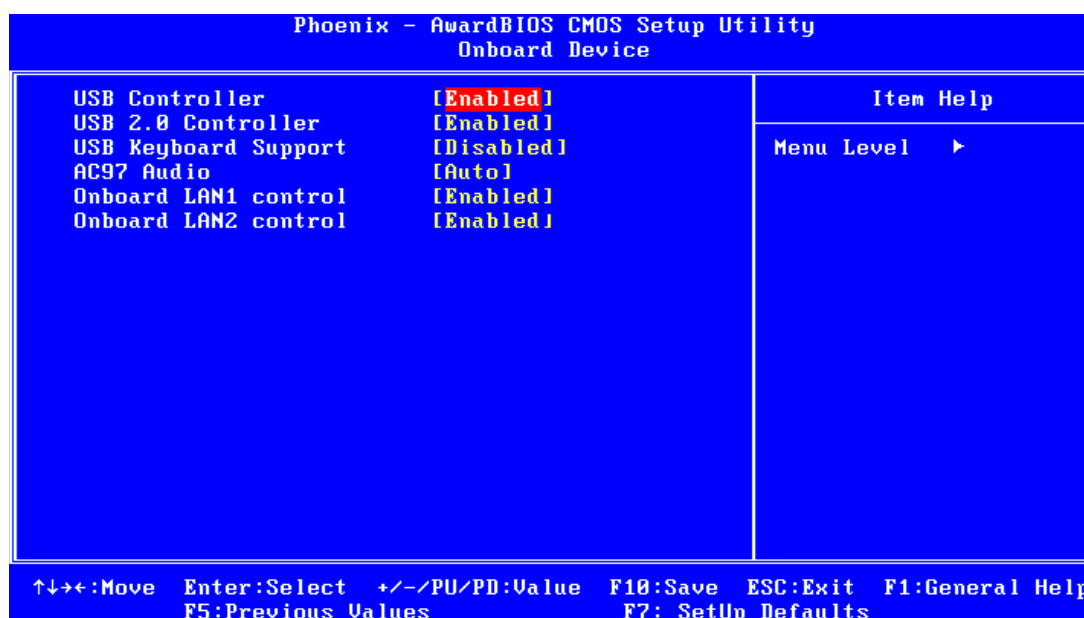

Figure 3.7 Onboard Device

### 3.6.5 USB Controller

Select Enabled if your system contains a Universal Serial Bus (USB) controller and you have USB peripherals. The choices: "Enabled," "Disabled."

### 3.6.6 USB 2.0 Controller

This entry is to disable/enable the USB 2.0 controller only. The BIOS itself may/may not have high-speed USB support. If the BIOS has high speed USB support built in, the support will automatically turn on when a high speed device is attached. The choices are : "Enabled" or "Disabled."

### 3.6.7 USB Keyboard/Mouse Support

Select Enabled if user plans to use an USB keyboard. The choices are: "Enabled", "Disabled."

### 3.6.8 AC-97 Audio

Select Disable if you do not want to use AC-97 audio. Option is "Auto", "Disabled."

### 3.6.9 Onboard LAN1 Control

Options are "Enabled" and "Disabled" Select Disable if user does not want to use onboard LAN controller1.

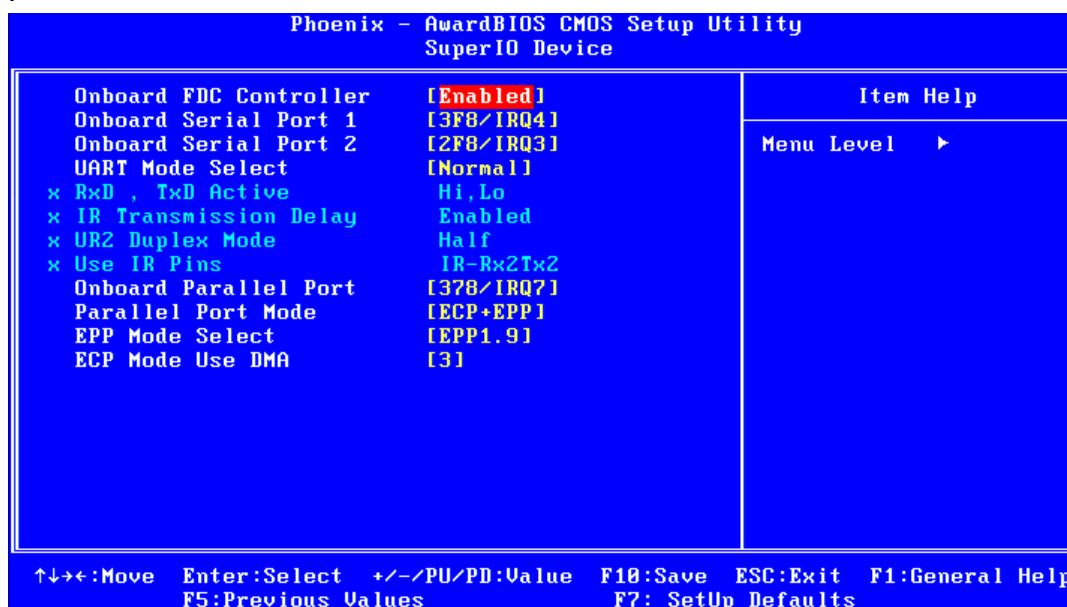

Figure 3.8 Super I/O Device

### 3.6.10 Onboard FDC Controller

When enabled, this field allows you to connect your floppy disk drives to the onboard floppy disk drive connector instead of a separate controller card. If you want to use a different controller card to connect the floppy disk drives, set this field to Disabled.

### 3.6.11 Onboard Serial Port 1

The settings are "3F8/IRQ4," "2F8/IRQ3," "3E8/IRQ4," "2E8/ IRQ3," and "Disabled" for the on-board serial connector.

### 3.6.12 Onboard Serial Port 2

The settings are "3F8/IRQ4", "2F8/IRQ3", "3E8/IRQ4", "2E8/ IRQ3" and "Disabled" for the on-board serial connector.

### 3.6.13 UART Mode Select

This item allows you to select UART mode. The choices: "IrDA", "ASKIR", "Normal".

### 3.6.14 RxD, TxD Active

This item allows you to determine the active of RxD, TxD. The Choices: "Hi, Hi," "Lo, Lo," "Lo, Hi," "Hi, Lo."

### 3.6.15 IR Transmission Delay

This item allows you to enable/disable IR transmission delay. The choices: "Enabled", "Disabled".

---

### 3.6.16 UR2 Duplex Mode

This item allows you to select the IR half/full duplex function. The choices: "Half", "Full."

### 3.6.17 Use IR Pins

The Choice : "RxD2, TxD2", "IR-Rx2Tx2".

### 3.6.18 Onboard Parallel Port

This field sets the address of the on-board parallel port connector. You can select either "378/IRQ7", "278/IRQ5", "3BC/IRQ7", or "Disabled". If you install an I/O card with a parallel port, make sure there is no conflict in the address assignments. The single board computer can support up to three parallel ports, as long as there are no conflicts for each port.

### 3.6.19 Parallel Port Mode

This field allows you to set the operation mode of the parallel port. The setting "Normal" allows normal speed operation, but in one direction only. "EPP" allows bidirectional parallel port operation at maximum speed. "ECP" allows the parallel port to operate in bi-directional mode and at a speed faster than the maximum data transfer rate. "ECP + EPP" allows normal speed operation in a two-way mode.

### 3.6.20 EPP Mode Select

This field allows you to select EPP port type 1.7 or 1.9. The choices: "EPP1.9", "EPP1.7".

### 3.6.21 ECP Mode Use DMA

This selection is available only if you select "ECP" or "ECP + EPP" in the Parallel Port Mode field. In ECP Mode, you can select DMA channel 1 or DMA channel 3. Leave this field on the default setting.

## 3.7 Power Management Setup

The power management setup controls the single board computer's "green" features to save power. The following screen shows the manufacturer's defaults.



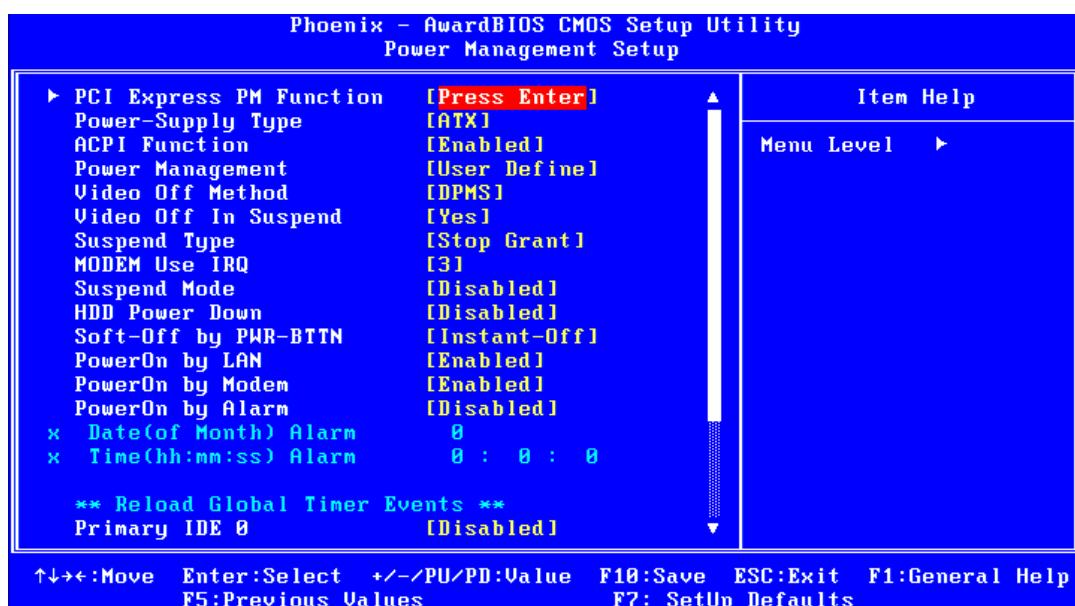

Figure 3.9 Power management setup screen (1)

### 3.7.1 PCI Express PM Function

This function is used to setup the PCI Express PME function. The choices are: "Enable" or "Disable"

### 3.7.2 Power Supply Type

PCA-6008 can support both "ATX" and "AT" power supply. Customers can choose the PSU type through this selection. The choices are: "ATX", "AT". While selecting "AT", the ACPI function will disable automatically.

### 3.7.3 ACPI Function

The choices are: "Enabled", "Disabled".

### 3.7.4 Power Management

This category allows you to select the type (or degree) of power saving and is directly related to the following modes:

1. HDD Power Down
2. Suspend Mode

There are three selections for Power Management, and they have fixed mode settings.

**Table 3.2: ,Power Saving**

Min Saving	Minimum power management., Suspend Mode = 1 hr., and HDD Power Down = =15 min.
Max Saving	Maximum power management., Suspend Mode = 1 min., and HDD Power Down = 1 min.
User Defined (Default)	Allows you to set each mode individually. When not disabled, each of the ranges are from 1 min. to 1 hr. except for HDD Power Down which ranges from 1 min. to 15 min, and disabled.

### 3.7.5 Video Off Method

Use this to select the method to turn off the video. The choices are : "Blank Screen", "V/H SYNC+ Blank", "DPMS".

### 3.7.6 Video Off In Suspend

When the system is in suspend mode, the video will turn off. The choices are "No" and "Yes".

### 3.7.7 Suspend Type

The choices are : "Stop Grant", "PwrOn Suspend".

### 3.7.8 Modem Use IRQ

This determines the IRQ that the MODEM can use.The choices are: "3", "4", "5", "7", "9", "10", "11", "NA".

### 3.7.9 Suspend Mode

Please refer to 3.7.4

### 3.7.10 HDD Power Down

Please refer to 3.7.4

### 3.7.11 Soft-Off by PWR-BTTN

If you choose "Instant-Off", then pushing the ATX soft power switch button once will switch the system to "system off" power mode. You can choose "Delay 4 sec." If you do, then pushing the button for more than 4 seconds will turn off the system, whereas pushing the button momentarily (for less than 4 seconds) will switch the system to "suspend" mode.

### 3.7.12 PowerOn by Modem

To enabled or disable the function to power on the system via Modem from the remotehost. The Choice : "Enabled", "Disabled".

### 3.7.13 PowerOn by LAN

This item allows you to power on the system by LAN. The choices: "Enabled," "Disabled."

### 3.7.14 PowerOn by Alarm

The Choice: "Enabled", "Disabled".

### 3.7.15 Primary IDE 0

When Enabled, the system will resume from suspend mode if Primary IDE 0 is active.  
The Choice: "Enabled", "Disabled"

## 3.8 PnP/PCI Configurations

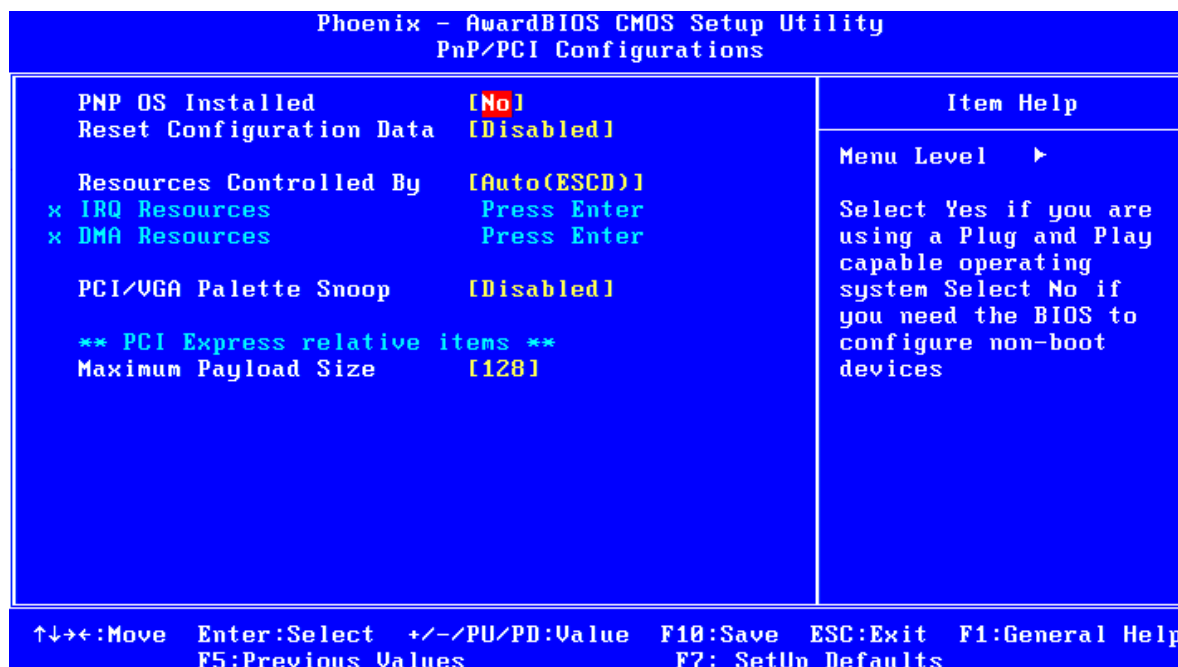

Figure 3.10 PnP/PCI configurations screen

### 3.8.1 PNP OS Installed

Set this option to Yes if a PNP OP is installed on your system. The default value for this setting is No.

### 3.8.2 Reset Configuration Data

Default is Disabled. Select Enable to reset Extended System Configuration Data (ESCD) if you have installed a new add-on, and system configuration has caused such a conflict that OS cannot boot.

### 3.8.3 Resources Controlled By

The commands here are "Auto(ESCD)" or "Manual." Choosing "Manual" requires you to choose resources from each following sub-menu. "Auto(ESCD)" automatically configures all of the boot and Plug and Play devices, but you must be using Windows 95 or above.

### 3.8.4 PCI/VGA Palette Snoop

This is set to "Disabled" by default.

### 3.8.5 Maximum Payload Size

It allows you to set the maximum TLP payload size for the PCI Express devices. Setting options: [128 bytes], [256 bytes], [512 bytes], [1024 bytes], [2048 bytes], [4096 bytes].

## 3.9 PC Health Status

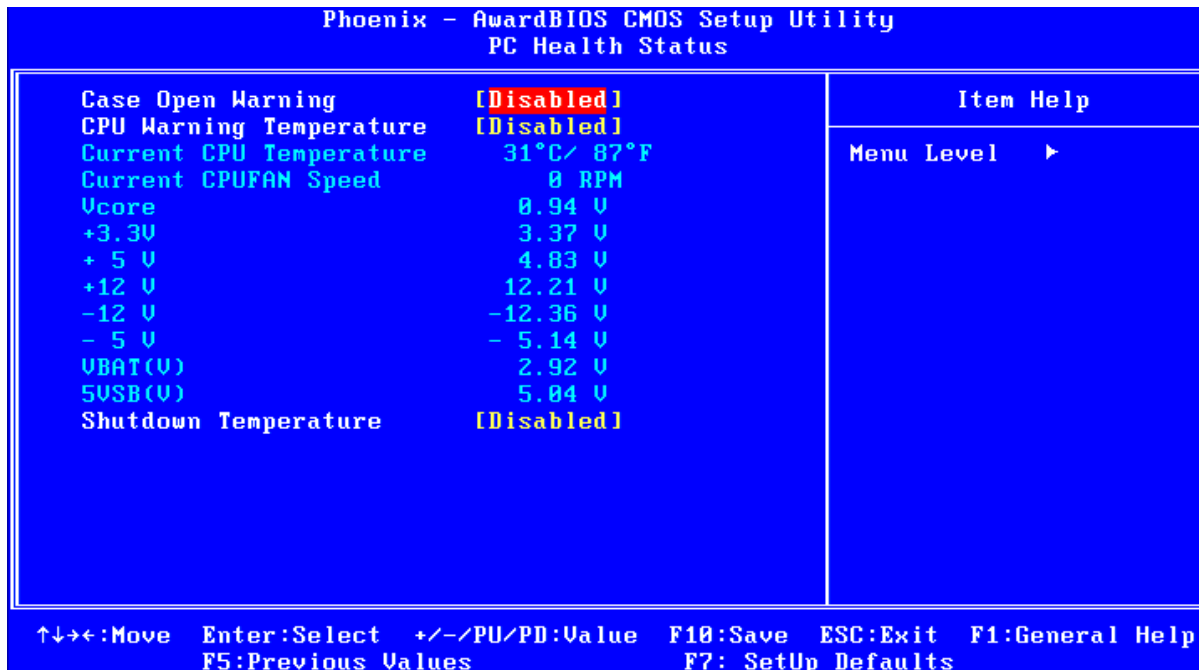

Figure 3.11 PC Health Status Screen

### 3.9.1 Case Open Warning

It allows the limit switch sensor of the chassis to detect if the case is open or closed.

### 3.9.2 CPU Warning Temperature

This item will prevent the CPU from overheating. The choices are: "Disabled," "60C/140F," "63C/145F," "66C/151F," "70C/158F," "75C/167F," "80C/176F," "85C/185F," "90C/194F," and "95C/205F."

### 3.9.3 Current CPU Temperature

This shows you the current CPU temperature.

### 3.9.4 CPU FAN Speed

This shows you the current CPU FAN operating speed.

### 3.9.5 VCORE and Other Voltages

This shows you the voltage of VCORE, VCC3, +5V, +12V, -12V, -5V, VBAT(V), and 5VSB(V).

### 3.9.6 Shutdown Temperature

The system will shut down automatically when the CPU temperature is over the selected setting. This function can prevent CPU damage caused by overheating.

## 3.10 Frequency / Voltage Control

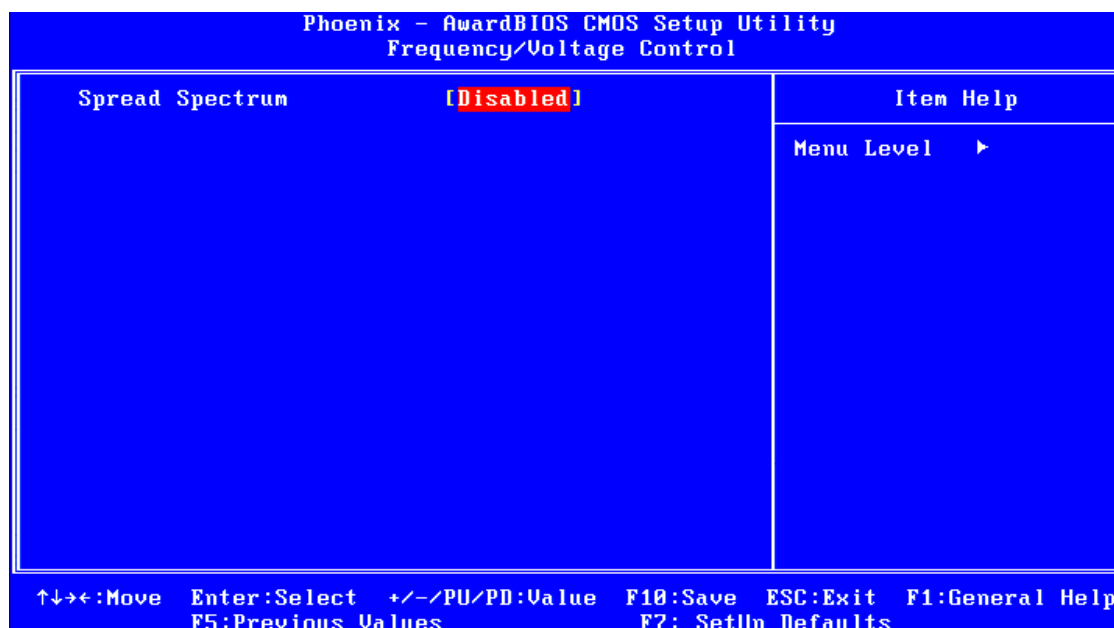

Figure 3.12 Spread Spectrum Control screen

### 3.10.1 Spread Spectrum

This setting allows you to reduce the EMI by modulating the signals the CPU generates so that the spikes are reduced to flatter curves. It achieves this by varying the frequency slightly so that the signal does not use any particular frequency for more than a moment. The choices are: "Disabled," and "Enabled."

## 3.11 Password Setting

To change the password:

1. Choose the "Set Password" option from the "Initial Setup Screen" menu and press <Enter>.

The screen will display the following message:

Please Enter Your Password

Press <Enter>.

2. If the CMOS is good or if this option has been used to change the default password, the user is asked for the password stored in the CMOS. The screen will display the following message:

Please Confirm Your Password

Enter the current password and press <Enter>.

3. After pressing <Enter> (ROM password) or the current password (user-defined), you can change the password stored in the CMOS. The password must be no longer than eight (8) characters.

Remember, to enable the password setting feature, you must first select either "Setup" or "System" from the "Advanced BIOS Features" menu.

---

## 3.12 Save & Exit Setup

If you select this and press <Enter>, the values entered in the setup utilities will be recorded in the CMOS memory of the chipset. The microprocessor will check this every time you turn your system on and compare this to what it finds as it checks the system. This record is required for the system to operate.

## 3.13 Exit Without Saving

Selecting this option and pressing <Enter> lets you exit the setup program without recording any new values or changing old ones.

# Chapter 4

Chipset Software  
Install Utility

## 4.1 Before you Begin

To facilitate the installation of the enhanced display device drivers and utility software, you should read the instructions in this chapter carefully before you attempt installation. The device drivers for the PCA-6008 board are located on the software installation CD. The auto-run function of the driver CD will guide and link you to the utilities and device drivers under a Windows system. The Intel® Chipset Software Installation Utility is not required on any systems running Windows NT 4.0. Updates are provided via Service Packs from Microsoft\*.

**Note!** *The files on the software installation CD are compressed. Do not attempt to install the drivers by copying the files manually. You must use the supplied SETUP program to install the drivers*



Before you begin, it is important to note that most display drivers need to have the relevant software application already installed in the system prior to installing the enhanced display drivers. In addition, many of the installation procedures assume that you are familiar with both the relevant software applications and operating system commands. Review the relevant operating system commands and the pertinent sections of your application software's user's manual before performing the installation.

## 4.2 Introduction

The Intel® Chipset Software Installation (CSI) utility installs to the target system the Windows INF files that outline to the operating system how the chipset components will be configured. This is needed for the proper functioning of the following features:

- Core PCI and ISA PnP services.
- AGP support.
- IDE Ultra ATA 100/66/33 and Serial ATA interface support.
- USB 1.1/2.0 support
- Identification of Intel® chipset components in the Device Manager.
- Integrates superior video features. These include filtered sealing of 720 pixel DVD content, and MPEG-2 motion compensation for software DVD

**Note!** *This utility is used for the following versions of Windows system, and it has to be installed before installing all the other drivers:*



Windows 2000

Windows NT

Windows XP

## 4.3 Windows XP Driver Setup

1. Insert the driver CD into your system's CD-ROM drive. In a few seconds, the software installation main menu appears. Move the mouse cursor over the "Auto" button under the "CSI UTILITY" heading.



2. A message pops up telling you to install the CSI utility before other device drivers. Click on this button. Taking Windows XP as example.
3. Click "Next" when you see the following message.



4. Click "Yes" when you see the following message.



5. Click "Next" when you see the following messages.



- When the following message appears, click "Finish" to complete the installation and restart Windows.





# Chapter 5

## VGA Setup

## 5.1 Introduction

The Intel 910GMLE integrated graphics controller provides an analog display port through SDVO ports. You need to install the VGA driver to enable the function.

The features include:

- Intel Graphics Media Accelerator 900: Incorporating the latest Microsoft\* DirectX\*9 support capabilities, it allows software developers to create real-life environments and characters. Dual independent display, enhanced display modes for widescreen flat panels, and optimized 3D support deliver an intense and realistic visual experience without requiring a separate graphics card.
- Intel Serial Digital Video Output (SDVO): The PCA-6008 supports CRTs via a VGA connector with a maximum pixel clock of 400 MHz (up to 2048x1536 resolution @ 85 Hz refresh rate)

## 5.2 Windows XP Driver Setup

**Note!** *Before installing this driver, make sure the CSI utility has been installed in your system. See Chapter 4 for information on installing the CSI utility*



Insert the driver CD into your system's CD-ROM drive. Select the folder "VGA" then click the proper VGA driver for the OS. Windows XP is used as an example in the following steps

1. Please click on "Next" to continue the installation

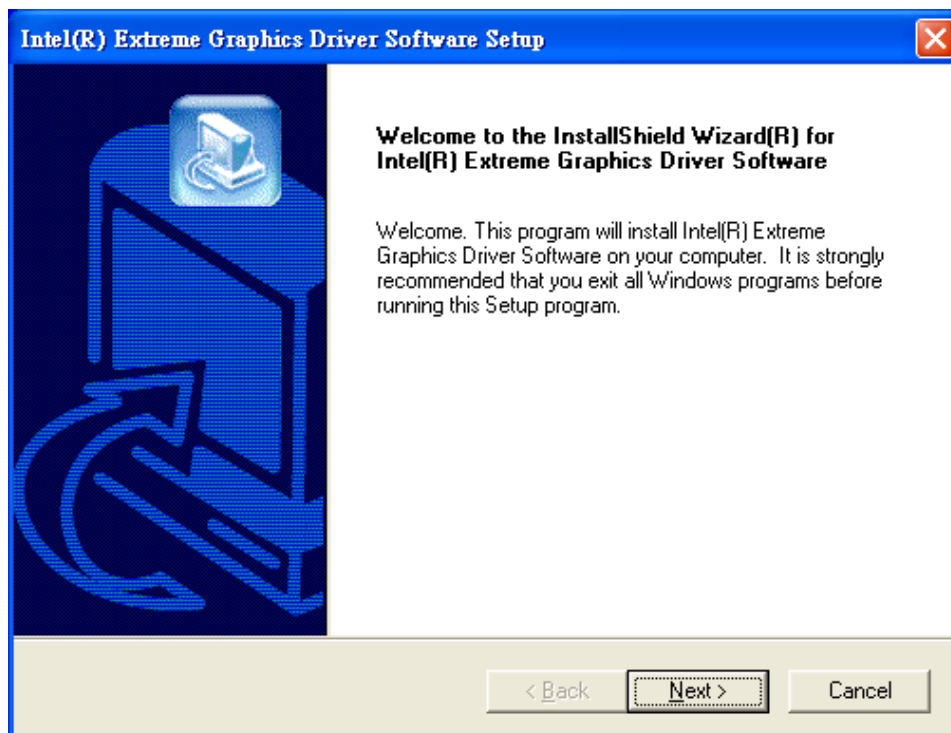

2. You will see a welcome window. Please click on "Yes" to continue the installation.

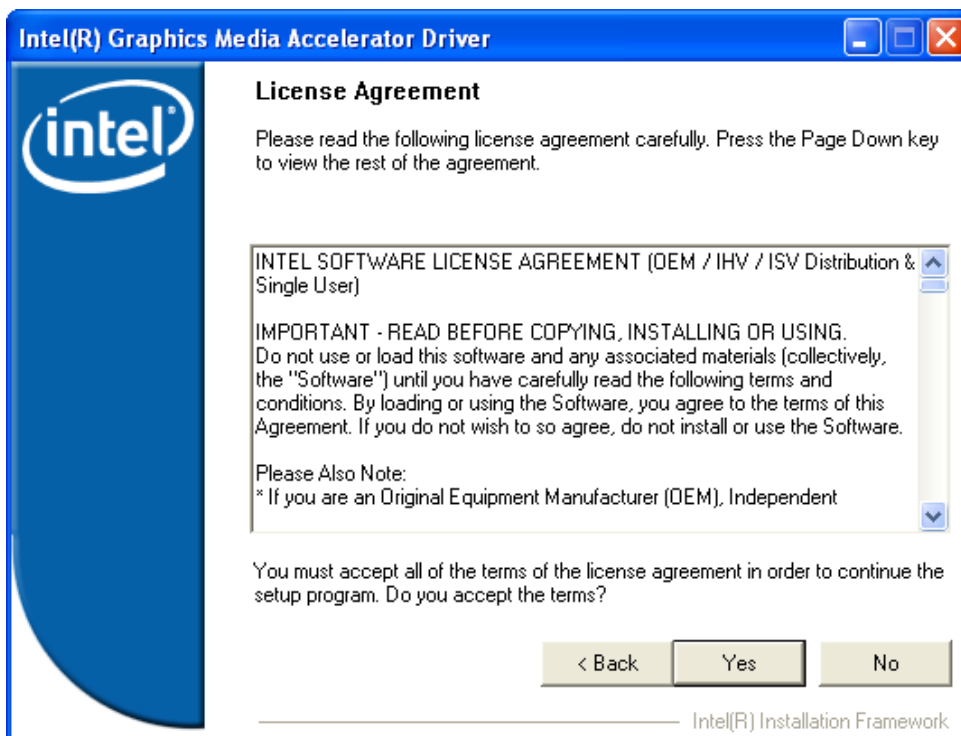

3. Click "Finish" to complete the installation and restart the computer now or later.

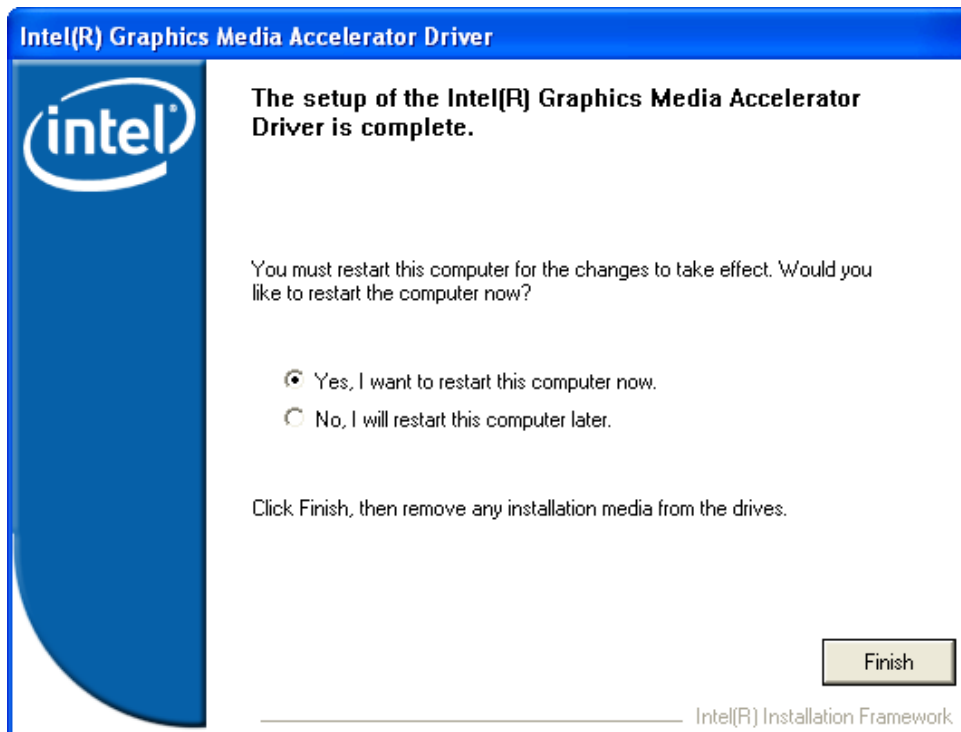





# Chapter 6

## LAN Configuration

---

## 6.1 Introduction

The PCA-6008 features single Gigabit Ethernet network interface. With the Realtek RTL8111B GbE controller designed-in, PCA-6008 implements the PCI Express host interface (PCI-E X1) in LAN connection with the maximum throughput of 2Gbps for heavy-duty industrial network application.

## 6.2 Features

Integrated 10/100/1000 BASE-T transceiver

1. 10/100/1000 BASE-T triple-speed MAC
2. High-speed RISC core with 24-KB cache
3. On-chip voltage regulation
4. Supporting Wake-on-LAN (WOL) function
5. PCI Express X1 host interface

## 6.3 Installation

**Note!** Before installing the LAN drivers, make sure the CSI utility has been installed on your system. See Chapter 4 for information on installing the CSI utility.



The PCA-6008's Realtek RTL8111B Gigabit integrated controller supports all major network operating systems. However, the installation procedure varies with different operating systems. In the following sections, refer to the one that provides driver setup procedure for the operating system you are using.

## 6.4 Win XP Driver Setup (Realtek RTL8111B)

1. Insert the driver CD into your system's CD-ROM drive. Select the "LAN" folder then click the proper Lan driver for the OS.
2. Please click on "Next" to continue the installation

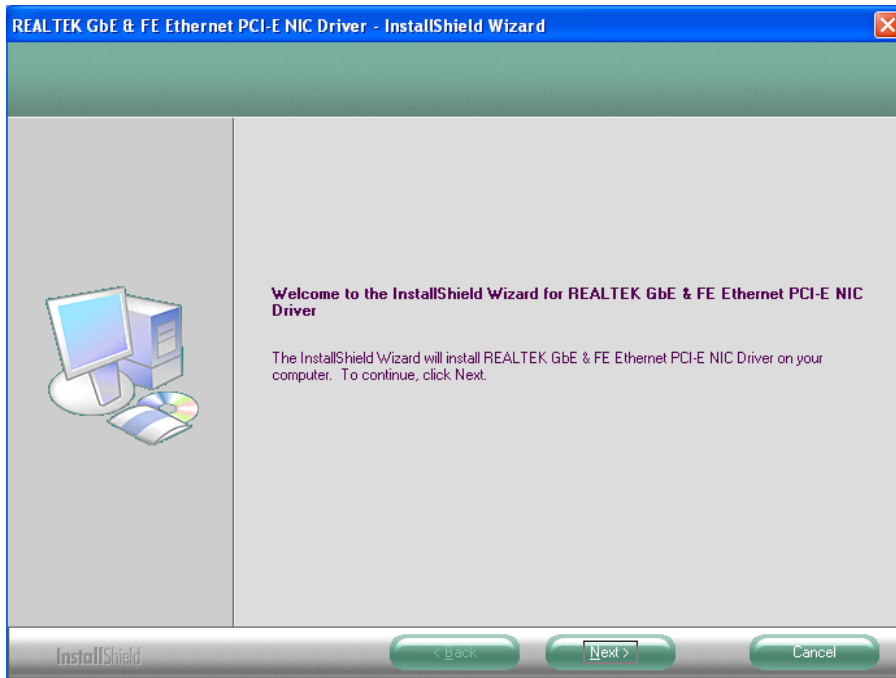

3. Click "Install" to continue.

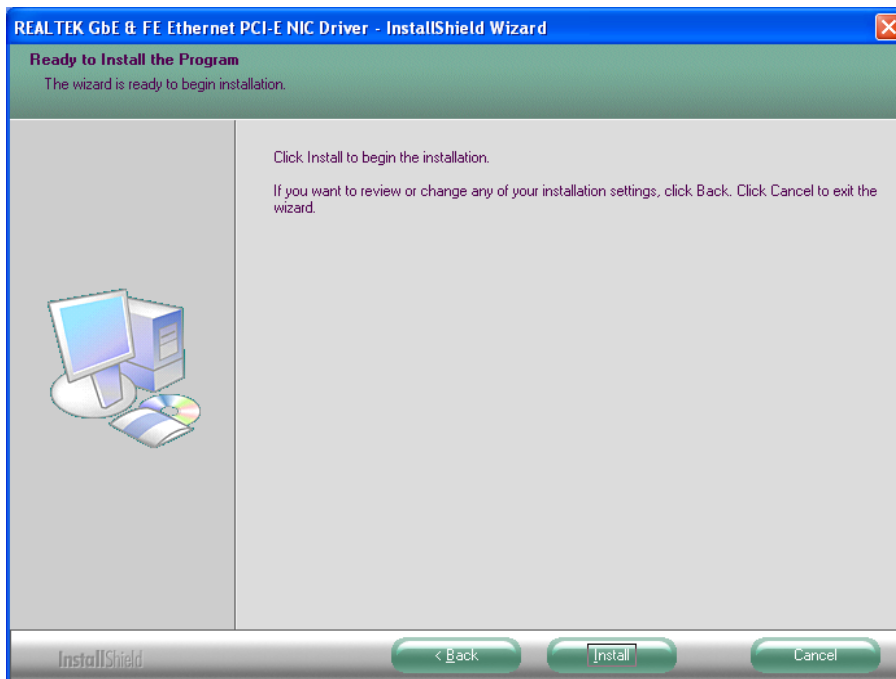

4. Click "Finish" to complete the installation.

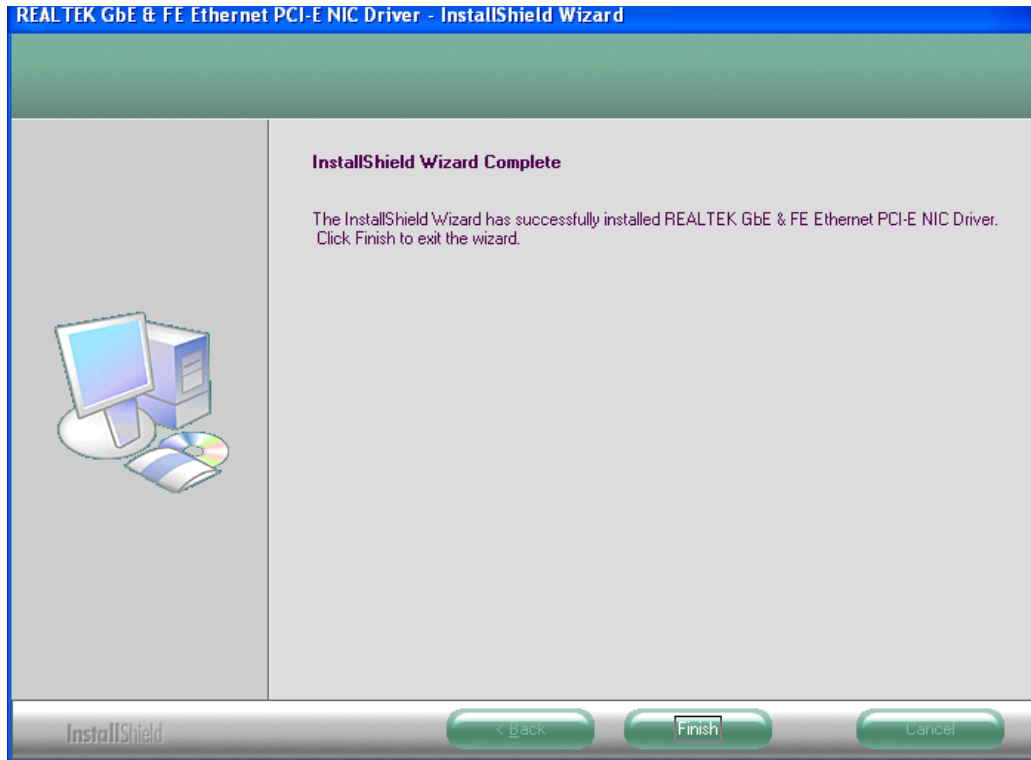

# Chapter 7

## USB 2.0 Configuration

---

## 7.1 Introduction

The PCA-6008 is designed with Intel ICH6M which supports both USB1.1 and USB 2.0 high-speed transmission. It remains compatible with today's USB device. High-speed USB 2.0 provides data transfer up to 480Mb/s which is 40 times faster than USB 1.1. It is ideal for today's speed-demanding I/O peripherals.

## 7.2 Features

- Provides data transmission rate up to 480Mb/s
- Offer 40X greater bandwidth than USB 1.1
- Offers complete compatibility with current USB device

## 7.3 Installation

**Note!** *Before installing this driver, make sure the CSI utility has been installed in your system. See Chapter 4 for information on installing the CSI utility.*



**Note!** *USB 2.0 driver is not available for Windows 98SE/ME from PCA-6008 driver CD. Under these operating systems, the USB device will operate at USB 1.1 speeds*



# Appendix **A**

Programming the  
Watchdog

## A.1 Programming the Watchdog Timer

The PCA-6008's watchdog timer can be used to monitor system software operation and take corrective action if the software fails to function after the programmed period. This section describes the operation of the watchdog timer and how to program it.

### A.1.1 Watchdog timer overview

The watchdog timer is built into the super I/O controller W83627HF. It provides the following functions for user programming:

- Can be enabled and disabled by user's program.
- Timer can be set from 1 to 255 seconds or 1 to 255 minutes.
- Generates an interrupt or resets signal if the software fails to reset the timer after time-out.

### A.1.2 Reset/ Interrupt selection

The JWDT1 jumper is used to select reset or interrupt (IRQ 11) in the event the watchdog timer is tripped. See Chapter 1 for detailed jumper settings.

**Note!** *The interrupt output of the watchdog timer is a low level signal. It will be held low until the watchdog timer is reset.*



### A.1.3 Programming the Watchdog Timer

The I/O port address of the watchdog timer is 2E(hex) and 2F(hex).

2E (hex) is the address port. 2F(hex) is the data port.

You must first assign the address of register by writing address value into address port 2E(hex), then write/read data to/from the assigned register through data port 2F (hex).



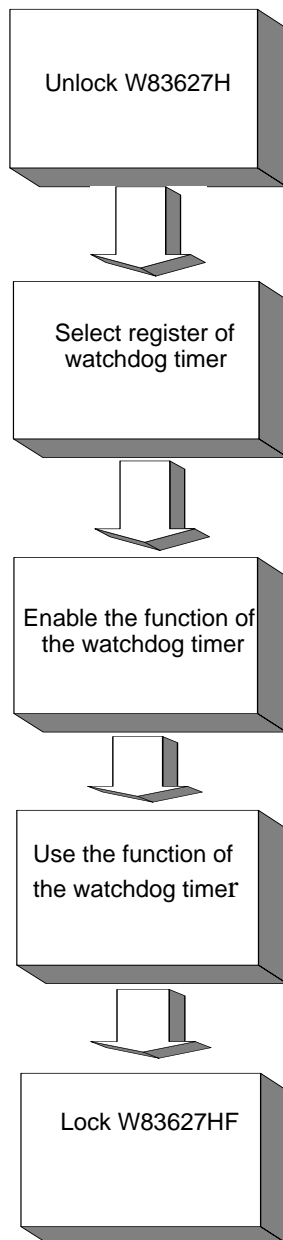

**Table A.1: Watchdog Timer Registers**

Address of register (2E)	Attribute	
Read/Write		Value (2F) and description
87 (hex)	-----	Write this address to I/O address port 2E (hex) twice to unlock the W83627HF
07 (hex)	write	Write 08 (hex) to select register of watchdog timer.
30 (hex)	write	Write 01 (hex) to enable the function of the watchdog timer. Disabled is set as default.
F5 (hex)	write	Set seconds or minutes as units for the timer.  Write 0 to bit 3: set second as counting unit. [default] Write 1 to bit 3: set minute as counting unit
F6 (hex)	write	0: stop timer [default] 01~FF (hex): The amount of the count, in seconds or minutes, depends on the value set in register F5 (hex). This number decides how long the watchdog timer waits for strobe before generating an interrupt or reset signal. Writing a new value to this register can reset the timer to count with the new value.
F7 (hex)	read/write	Bit 6: Write 1 to enable keyboard to reset the timer, 0 to disable. [default] Bit 5: Write 1 to generate a timeout signal immediately and automatically return to 0. [default=0] Bit 4: Read status of watchdog timer, 1 means timer is "time out".
AA (hex)	-----	Write this address to I/O port 2E (hex) to lock the watchdog timer.

### A.1.4 Example Program

1. Enable watchdog timer and set 10 sec. as timeout interval

```

;-----
Mov dx,2eh                ; Unlock W83627HF
Mov al,87h
Out dx,al
Out dx,al
;-----
Mov al,07h                ; Select registers of watchdog timer
Out dx,al
Inc dx
Mov al,08h
Out dx,al
;-----
Dec dx                    ; Enable the function of watchdog timer
Mov al,30h
Out dx,al
Inc dx
Mov al,01h
Out dx,al
;-----
Dec dx                    ; Set second as counting unit
Mov al,0f5h
Out dx,al
Inc dx
In al,dx
And al,not 08h
Out dx,al
;-----
Dec dx                    ; Set timeout interval as 10 seconds and start counting
Mov al,0f6h
Out dx,al
Inc dx
Mov al,10
Out dx,al
;-----
Dec dx                    ; lock W83627HF
Mov al,0aah
Out dx,al

```

2. Enable watchdog timer and set 5 minutes as timeout interval

```

;-----
Mov dx,2eh                ; unlock W83627H
Mov al,87h
Out dx,al

```

```

Out dx,al
;-----
Mov al,07h      ; Select registers of watchdog timer
Out  dx,al
Inc  dx
Mov  al,08h
Out  dx,al
;-----
Dec dx          ; Enable the function of watchdog timer
Mov  al,30h
Out  dx,al
Inc  dx
Mov  al,01h
Out  dx,al
;-----
Dec dx          ; Set minute as counting unit
Mov  al,0f5h
Out  dx,al
Inc  dx
In   al,dx
Or  al,08h
Out  dx,al
;-----
Dec dx          ; Set timeout interval as 5 minutes and start counting
Mov  al,0f6h
Out  dx,al
Inc  dx
Mov  al,5
Out  dx,al
;-----
Dec dx          ; lock W83627HF
Mov  al,0aah
Out  dx,al

```

### 3. Enable watchdog timer to be reset by mouse

```

;-----
Mov dx,2eh      ; unlock W83627H
Mov al,87h
Out dx,al
Out dx,al
;-----
Mov al,07h      ; Select registers of watchdog timer
Out  dx,al
Inc  dx
Mov  al,08h

```

```

Out    dx,al
;-----
Dec dx          ; Enable the function of watchdog timer
Mov    al,30h
Out    dx,al
Inc    dx
Mov    al,01h
Out    dx,al
;-----
Dec dx          ; Enable watchdog timer to be reset by mouse
Mov    al,0f7h
Out    dx,al
Inc    dx
In     al,dx
Or    al,80h
Out    dx,al
;-----
Dec dx          ; lock W83627HF
Mov    al,0aah
Out    dx,al

4. Enable watchdog timer to be reset by keyboard
;-----
Mov dx,2eh      ; unlock W83627H
Mov al,87h
Out dx,al
Out dx,al
;-----
Mov al,07h      ; Select registers of watchdog timer
Out  dx,al
Inc  dx
Mov  al,08h
Out  dx,al
;-----
Dec dx          ; Enable the function of watchdog timer
Mov  al,30h
Out  dx,al
Inc  dx
Mov  al,01h
Out  dx,al
;-----
Dec dx          ; Enable watchdog timer to be strobed reset by keyboard
Mov  al,0f7h
Out  dx,al
Inc  dx

```

```

In    al,dx
Or   al,40h
Out   dx,al
;-----
Dec dx      ; lock W83627HF
Mov   al,0aah
Out   dx,al

5.   Generate a time-out signal without timer counting
;-----
Mov dx,2eh      ; unlock W83627H
Mov al,87h
Out dx,al
Out dx,al
;-----
Mov al,07h      ; Select registers of watchdog timer
Out   dx,al
Inc   dx
Mov   al,08h
Out   dx,al
;-----
Dec dx      ; Enable the function of watchdog timer
Mov   al,30h
Out   dx,al
Inc   dx
Mov   al,01h
Out   dx,al
;-----
Dec dx      ; Generate a time-out signal
Mov   al,0f7h
Out   dx,al      ;Write 1 to bit 5 of F7 register
Inc   dx
In    al,dx
Or   al,20h
Out   dx,al
;-----
Dec dx      ; lock W83627HF
Mov   al,0aah
Out   dx,al

```

# Appendix **B**

Programming the  
GPIO

## B.1 Sample Code

```
-----  
; MTEST1 _M_HL=05 GP10-13=GPO GP14-17=GPI  
; _M_HL=50 GP10-13=GPI GP14-17=GPO  
-----  
MTEST1 MACRO _M_HL  
    LOCAL _M_Begin,_M_END,_M_LOP1  
_M_Begin:  
    MOV DX,2Eh ; 2E/2F=F1/05 (CR-F1)  
    MOV AL,0F1h ; =F1/50 (CR-F1)  
    OUT DX,AL ;-Index  
    MOV DX,2Fh ;  
    MOV al,_M_HL ;AL<--05/50  
    OUT DX,AL ;-Data  
    MOV DX,2Fh ;  
    IN AL,DX ;-Data  
    cmp al,55h ;  
    jz _M_LOP1 ;  
    jmp _M_Begin ;  
_M_LOP1:  
    MOV DX,2Fh ;  
    MOV AL,_M_HL ;AL<-05/50  
    SHL AL,1 ;05/50 -->0A/A0  
    OUT DX,AL ;-Data  
    MOV DX,2Fh ;  
    IN AL,DX ;-Data  
    cmp al,0AAh ;  
    jz _M_END ;  
    jmp _M_Begin ;  
_M_END:  
    ENDM  
-----  
; Logic_Dev_Sel  
-----  
Logic_Dev_Sel MACRO Log_Dev  
    MOV DX,2Eh ;  
    MOV AL,07h ; Point To Logical Device Number Reg.  
    OUT DX,AL ;  
    MOV DX,2Fh ;  
    MOV AL,Log_Dev ; Select Logical Device Number 7  
    OUT DX,AL ; (GAME/MIDI/GPIO Port)  
    ENDM ;  
-----  
;-----  
AnyKey MACRO ;
```



```

MOV  AH,01H    ;
INT  21H      ;
ENDM          ;
;-----
;-----
PRINT MACRO String
    mov  dx,offset string
    MOV  AH,09H
    INT  21H
    ENDM
;-----
.MODEL SMALL
.386
.DATA
MSG_1 db  0ah,0dh,"GP10-13 Output/GP14-17 Input .....$"
MSG_2 db  0ah,0dh,"GP10-13 Input /GP14-17 Output .....$"
MSG_3 db  "Test OK! $" ,0ah,0dh
.CODE
BEGIN: MOV  AX,@DATA
MOV  DS,AX
MOV  DX,2Eh    ; Enter the Extended Function
MOV  AL,87h    ; Mode, Interruptible Double-Write
OUT  DX,AL    ;
OUT  DX,AL    ;
MOV  AL,2Ah    ; Set Configuration Register
MOV  DX,2Eh    ;
OUT  DX,AL    ;-Index
MOV  DX,2Fh    ;
IN   AL,DX    ;;Read CR-2A, Set Bit[7:2]=1
OR   AL,0FCh  ;;Write Back CR-2A
MOV  DX,2Fh    ;;
OUT  DX,AL    ;;-Data
Logic_Dev_Sel 7
mov  dx,2eh    ;Logic Device 7 CR-F0(GPIO 10-17)
mov  al,0f0h   ;
out  dx,al    ;-Index (F0)
mov  dx,2fh    ;
mov  al,0f0h   ; 1=GPI/0=GPO GPIO[7:4]=GPI
out  dx,al    ;-Data(F0) GPIO[3:0]=GPO
Print MSG_1
MTEST1 05h    ;05h=0101B
Print MSG_3
AnyKey

mov  dx,2eh    ;Logic Device 7 CR-F0(GPIO 10-17)

```

```
mov  al,0f0h    ;
out  dx,al     ;-Index (F0)
mov  dx,2fh    ;
mov  al,0fh    ; 1=GPI/0=GPO GPIO[7:4]=GPO
out  dx,al     ;-Data(0F)  GPIO[3:0]=GPI
Print MSG_2
MTEST1 50h     ;50h=0101b
Print MSG_3
```

;------

```
MOV  AH,4CH
INT  21H
END  BEGIN
END
```

# Appendix **C**

## Pin Assignments

## C.1 IDE Hard Drive Connector (IDE1)

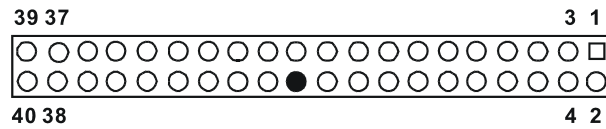
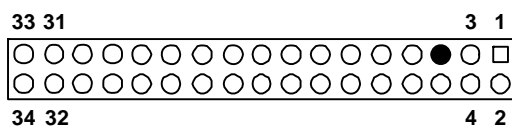

**Table C.1: IDE hard drive connector (IDE1)**

Pin	Signal	Pin	Signal
1	IDE RESET*	2	GND
3	DATA 7	4	DATA 8
5	DATA 6	6	DATA 9
7	DATA 5	8	DATA 10
9	DATA 4	10	DATA 11
11	DATA 3	12	DATA 12
13	DATA 2	14	DATA 13
15	DATA 1	16	DATA 14
17	DATA 0	18	DATA 15
19	SIGNAL GND	20	N/C
21	DISK DMA REQUEST	22	GND
23	IO WRITE	24	GND
25	IO READ	26	GND
27	IO CHANNEL READY	28	CSEL
29	HDACKO*	30	GND
31	IRQ14	32	N/C
33	ADDR 1	34	IDE_P66DET
35	ADDR 0	36	ADDR 2
37	PDCS#1	38	PDCS#3
39	IDE ACTIVE*	40	GND

\* low  
active

## C.2 Floppy Drive Connector (FDD1)

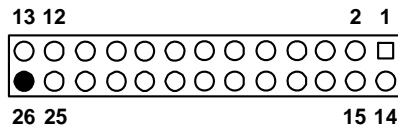

**Table C.2: Floppy drive connector (FDD1)**

Pin	Signal	Pin	Signal
1	GND	2	RWC
3	GND	4	N/C
5	N/C	6	DS1
7	GND	8	INDEX*
9	GND	10	MOTOR 0*
11	GND	12	DRIVE SELECT 1*
13	GND	14	DRIVE SELECT 0*
15	GND	16	MOTOR 1*
17	GND	18	DIRECTION*
19	GND	20	STEP*
21	GND	22	WRITE DATA*
23	GND	24	WRITE GATE*
25	GND	26	TRACK 0*
27	GND	28	WRITE PROTECT*
29	GND	30	READ DATA*
31	GND	32	HEAD SELECT*
33	GND	34	DISK CHANGE*

\* low active

## C.3 Parallel Port Connector (LPT1)

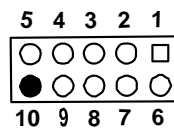

**Table C.3: Parallel port connector (CN4)**

Pin	Signal	Pin	Signal
1	STROBE*	2	D0
3	D1	4	D2
5	D3	6	D4
7	D5	8	D6
9	D7	10	ACK*
11	BUSY	12	PE
13	SLCT	14	AUTOFD*
15	ERR	16	INIT*
17	SLCTINI*	18	GND
19	GND	20	GND
21	GND	22	GND
23	GND	24	GND
25	GND	26	N/C

\* low active

## C.4 USB Connector (USB12, USB34, USB56, USB78)



**Table C.4: USB1/USB2 connector (USB12)**

Pin	USB1 Signal	Pin	USB2 Signal
1	+5 V	2	UV-
3	UV+	4	GND
5	N/C	6	+5 V
7	UV-	8	UV+
9	GND	10	GND

## C.5 VGA Connector (VGA1)

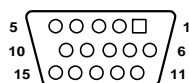

**Table C.5: VGA connector (CN7)**

Pin	Signal	Pin	Signal
1	RED	2	GREEN
3	BLUE	4	N/C
5	GND	6	GND
7	GND	8	GND
9	VCC	10	GND
11	N/C	12	SDT
13	H-SYNC	14	V-SYNC
15	SCK		

## C.6 RS-232 Serial Port (COM1, COM2)

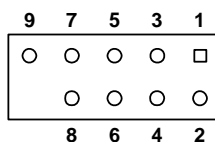

**Table C.6: RS-232 Serial Port (COM1, COM2)**

Pin	Signal
1	DCD
2	RXD
3	SIN
4	RTS
5	SOUT
6	CTS
7	DTR
8	RI
9	GND

## C.7 PS/2 Keyboard/ Mouse Connector (KBMS1)

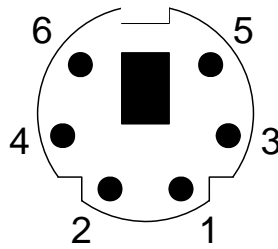

**Table C.7: PS/2 Keyboard/ Mouse connector (KBMS1)**

Pin	Signal
1	KB DATA
2	MS DATA
3	GND
4	VCC
5	MSVCC
6	MS CLOCK

## C.8 External Keyboard Connector (KBMS2)

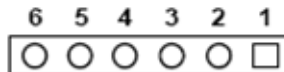
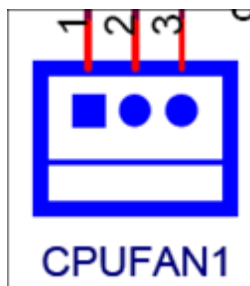

**Table C.8: External keyboard connector (KBMS2)**

Pin	Signal
1	CLK
2	DATA
3	NC
4	GND
5	VCC



## C.9 CPU Fan Power Connector (CPUFAN1)

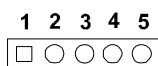

**Table C.9: CPU Fan Power Connector (CPUFAN1)**

Pin	Signal
1	GND
2	+12 V
3	FANIO

## C.10 Power LED & Keyboard Lock Connector (JFP3)

You can use an LED to indicate when the single board computer is on. Pin 1 of JFP3 supplies the LED's power, and Pin 3 is the ground.

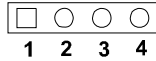

**Table C.10: Power LED and keylock conn (JFP3)**

Pin	Function
1	Power LED (+5 V)
2	NC
3	GND
4	KEYLOCK#
5	GND

## C.11 External Speaker Connector (JFP2/ SPEAKER)

The single board computer has its own buzzer. You can also connect it to the external speaker on your computer chassis.



**Table C.11: External Speaker Connector (JFP2/SPEAKER)**

Pin	Function
1	SPK+
2	NC
3	SPK_IN
4	SPK-

## C.12 Reset Connector (JFP1/ RESET)



**Table C.12: Reset connector (JFP1/ RESET)**

Pin	Signal
1	RESET
2	GND

## C.13 HDD LED Connector (JFP2/ HDDLED)



**Table C.13: HDD LED connector (JFP2/ HDDLED)**

Pin	Signal
1	VCC (LED+)
2	HDD LED (LED-)

## C.14 ATX Feature Connector (JATXF1)

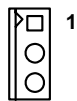

**Table C.14: ATX feature connector (JATXF1)**

Pin	Signal
1	PS-ON
2	VCC
3	5 V <sub>SB</sub>

## C.15 ATX Soft Power Switch (JFP1/ PWR\_SW)



**Table C.15: ATX soft power switch (JFP1/ PWR\_SW)**

Pin	Signal
1	5VSB
2	PWR-BTN

## C.16 H/W Monitor Alarm (JOBS1)

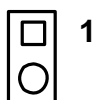

**Table C.16: H/W monitor alarm (JOBS1)**

Pin	Signal
1	OBS_BEEP
2	ERR_BEEP

## C.17 AC-97 Audio Interface (AC-97)

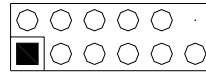

**Table C.17: AC-97 Audio Interface (AC-97)**

Pin	Signal
1 VCC	2 GND
3 SYNC	4 BITCLK
5 SDOUT	6 SDIN0
7 SDIN1	8 AC-RST
9 +12V	10 GND
11 GND	12 N/C

## C.18 SM Bus Connector (JFP2/ SNMP)

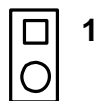

**Table C.18: SM Bus Connector (JFP2/ SNMP)**

Pin	Signal
1	SMB_DATA
2	SMB_CLK

## C.19 Case Open Connector (JCASE)

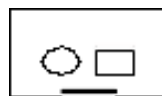

**Table C.19: Case Open ConnectorJ (CASE)**

Pin	Signal
1	CASEOP#
2	GND

## C.20 LAN1 and LAN2 connector (LANLED1)

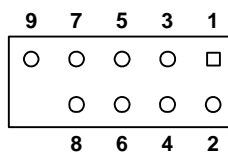

**Table C.20: LAN1 and LAN2 connector (LANLED1)**

Pin	Signal	Pin	Signal
1	LAN1_LINK	2	LAN2_LINK
3	LAN1_ACT	4	LAN2_ACT
5	LAN1_LINK1000	6	LAN2_LINK1000
7	LAN1_LINK100	8	LAN2_LINK100
9	VCC3SB		

## C.21 GPIO Pin Header (GPIO1)

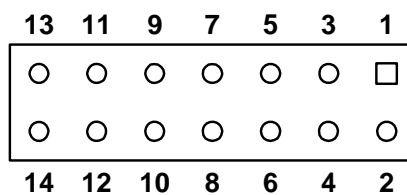

**Table C.21: GPIO pin header (GPIO1)**

Pin	Signal	Pin	Signal
1	GPIO_PORT80_1	2	GPIO_PORT80_5
3	VCC_GPIO	4	GND
5	GPIO_PORT80_2	6	GPIO_PORT80_6
7	GND	8	GND
9	GPIO_PORT80_3	10	GPIO_PORT80_7
11	GND	12	GND
13	GPIO_PORT80_4	14	GPIO_PORT80_8

## C.22 System I/O Ports

**Table C.22: System I/O ports**

<b>Addr. range (Hex)</b>	<b>Device</b>
000-01F	DMA controller
020-02D	Interrupt controller
02E-02F	LPC SIO
030-03D	Interrupt Controller
040-043 & 050-053	8254 timer
04E-04F	LPC SIO
060-06F	8042 (keyboard controller)
070-07F	Real-time clock, non-maskable interrupt (NMI) mask
080-09F	DMA page register
0A0-0BF	Interrupt controller
0C0-0DF	DMA controller
0F0	Process I/F
1T0-177	IDE or SATA controller
1F0-1F7	IDE or SATA controller
290-297	On-board hardware monitor
2F8-2FF	Serial port 2
378-37F	Parallel printer port 1 (LPT1)
3C0-3CF	Reserved
3D0-3DF	Color/graphics monitor adapter
3F0-3F7	Diskette controller
3F8-3FF	Serial port 1
4F8-4FF	COM3
4E8-4EF	COM4
4F0-4F7	COM5
4E0-4E7	COM6
4D0-4D1	Interrupt Controller
CF9	Reset Generator

## C.23 DMA Channel Assignments

**Table C.23: DMA channel assignments**

Channel	Function
0	Available
1	Available
2	Floppy disk (8-bit transfer)
3	Parallel port
4	Cascade for DMA controller 1
5	Available
6	Available
7	Available

## C.24 Interrupt Assignments

**Table C.24: Interrupt assignments**

Priority	Interrupt#	Interrupt source
1	NMI	Parity error detected
2	IRQ0	Interval timer
3	IRQ1	Keyboard
-	IRQ2	Interrupt from controller 2 (cascade)
4	IRQ8	Real-time clock
5	IRQ9	Cascaded to INT 0A (IRQ 2)
6	IRQ10	Available (Serial COMM 3 ~ 6)
7	IRQ11	Available
8	IRQ12	PS/2 mouse
9	IRQ13	INT from co-processor
10	IRQ14	Primary IDE Channel
11	IRQ15	Secondary IDE Channel
12	IRQ3	Serial communication port 2
13	IRQ4	Serial communication port 1
14	IRQ5	Parallel port 2
15	IRQ6	Diskette controller (FDC)
16	IRQ7	Parallel port 1 (print port)

## C.25 1st MB Memory Map

**Table C.25: 1st MB memory map**

Addr. range (Hex)	Device
E0000h - FFFFFh	BIOS
D0000h- DFFFFh	Unused
C0000h - CFFFFh	VGA BIOS
A0000h - BFFFFh	Video Memory
00000h - 9FFFFh	Base memory

## C.26 PCI Bus Map

**Table C.26: PCI bus map**

Function Signals	Device ID	INT# pin	GNT	REQ
Bridge	AD22		GNT 4	REQ 4
PCI slot 1	AD31	INT B, C, D, A	GNT A	REQ A
PCI slot 2	AD30	INT C, D, A, B	GNT B	REQ B
PCI slot 3	AD29	INT D, A, B, C	GNT C	REQ C
PCI slot 4	AD28	INT A, B, C, D	GNT D	REQ D





**ADVANTECH**

*Enabling an Intelligent Planet*

**[www.advantech.com](http://www.advantech.com)**

Please verify specifications before quoting. This guide is intended for reference purposes only.

All product specifications are subject to change without notice.

No part of this publication may be reproduced in any form or by any means, electronic, photocopying, recording or otherwise, without prior written permission of the publisher.

All brand and product names are trademarks or registered trademarks of their respective companies.

© Advantelch Co., Ltd. 2011