



User Manual

AIMB-274

**Intel® Core™ i7/i5/i3/Pentium/
Celeron LGA1150 Mini-ITX with
CRT/LVDS/DP/DP-HDMI, 2 COM,
Dual LAN, PCIe x16**

ADVANTECH

Enabling an Intelligent Planet

Copyright

The documentation and the software included with this product are copyrighted 2013 by Advantech Co., Ltd. All rights are reserved. Advantech Co., Ltd. reserves the right to make improvements in the products described in this manual at any time without notice.

No part of this manual may be reproduced, copied, translated or transmitted in any form or by any means without the prior written permission of Advantech Co., Ltd. Information provided in this manual is intended to be accurate and reliable. However, Advantech Co., Ltd. assumes no responsibility for its use, nor for any infringements of the rights of third parties, which may result from its use.

Acknowledgements

AMI is a trademark of Phoenix Technologies Ltd.

IBM and PC are trademarks of International Business Machines Corporation.

Intel® Core™ i7/i5/i3, Pentium, Celeron® is trademark of Intel Corporation

WinBond is a trademark of Winbond Corporation.

All other product names or trademarks are properties of their respective owners.

A Message to the Customer

Advantech Customer Services

Each and every Advantech product is built to the most exacting specifications to ensure reliable performance in the harsh and demanding conditions typical of industrial environments. Whether your new Advantech equipment is destined for the laboratory or the factory floor, you can be assured that your product will provide the reliability and ease of operation for which the name Advantech has come to be known.

Your satisfaction is our primary concern. Here is a guide to Advantech's customer services. To ensure you get the full benefit of our services, please follow the instructions below carefully.

Technical Support

We want you to get the maximum performance from your products. So if you run into technical difficulties, we are here to help. For the most frequently asked questions, you can easily find answers in your product documentation. These answers are normally a lot more detailed than the ones we can give over the phone.

So please consult this manual first. If you still cannot find the answer, gather all the information or questions that apply to your problem, and with the product close at hand, call your dealer. Our dealers are well trained and ready to give you the support you need to get the most from your Advantech products. In fact, most problems reported are minor and are able to be easily solved over the phone.

In addition, free technical support is available from Advantech engineers every business day. We are always ready to give advice on application requirements or specific information on the installation and operation of any of our products.

Declaration of Conformity

FCC Class B

This device complies with the requirements in part 15 of the FCC rules:

Operation is subject to the following two conditions:

- This device may not cause harmful interference
- This device must accept any interference received, including interference that may cause undesired operation.

This equipment has been tested and found to comply with the limits for a Class B digital device, pursuant to Part 15 of the FCC Rules. These limits are designed to provide reasonable protection against harmful interference when the equipment is operated in a commercial environment. This equipment generates, uses, and can radiate radio frequency energy and, if not installed and used in accordance with the instruction manual, may cause harmful interference to radio communications. Operation of this device in a residential area is likely to cause harmful interference in which case the user will be required to correct the interference at his/her own expense. The user is advised that any equipment changes or modifications not expressly approved by the party responsible for compliance would void the compliance to FCC regulations and therefore, the user's authority to operate the equipment.

Caution! *There is a danger of a new battery exploding if it is incorrectly installed. Do not attempt to recharge, force open, or heat the battery. Replace the battery only with the same or equivalent type recommended by the manufacturer. Discard used batteries according to the manufacturer's instructions.*



CPU Compatibility

CPU Family	Speed	TDP	L3 cache
QS QE75 I5-4670S	3.1GHz	65W	6MB
QS QE73 I7-4770S 3.1G	3.1GHz	65W	8MB
QE74 I5-4570S 2.9G	2.9GHz	65W	6MB
I5-4570TE	2.7GHz	35W	4MB
E3-1268L (QEEG) V3	2.3GHz	45W	8MB
I3-4330 (QDMX)	3.5GHz	65W	3MB
Pentium G3420 (QDN1)	3.2GHz	65W	3MB

Memory Compatibility

Test Item	Description						Result
Brand	Size	Speed	Type	ECC	Vendor PN	Memory	
Transcend	1GB	DDR3 1066	SODIMM DDR3	N	TS128MSK64 V1U	SEC K4B1G0846G- BCH9	PASS
Transcend	2GB	DDR3 1066	SODIMM DDR3	N	TS128MSK64 V1U	SEC HCH9 K4B1G0846D (128x8)	PASS
Transcend	4GB	DDR3 1066	SODIMM DDR3	N	TS7KSN2842 0-1Y	HYNIX H5TQ2G83BFR (256x8)	PASS
Apacer	4GB	DDR3 1066	SODIMM DDR3	N	78.B2GC8.AF 1	HYNIX H5TQ2G83BFR (256x8)	PASS
Transcend	1GB	DDR3 1333	SODIMM DDR3	N	TS128MSK64 V3U	ELPIDA J1108BFBG-DJ-F	PASS
Transcend	2GB	DDR3 1333	SODIMM DDR3	N	TS256MSK64 V3N	HYNIX H5TQ2G83CFR	PASS
Transcend	2GB	DDR3 1333	SODIMM DDR3	N	TS256MSK64 W3N	SEC 234 HYK0 K4B2G0846D	PASS
Transcend	4GB	DDR3 1333	SODIMM DDR3	N	TS512MSK64 V3N	HYNIX H5TQ2G83BFR (256x8)	PASS
Transcend	4GB	DDR3 1333	SODIMM DDR3	N	TS512MSK64 V3N	HYNIX H5TQ2G83CFR H9C 144AK 256x8	PASS
Transcend	8GB	DDR3 1333	SODIMM DDR3	N	TS1GSK64V3 H	MICRON IZD27 D9PBC 79T5 512x8	PASS
Apacer	1GB	DDR3 1333	SODIMM DDR3	N	78.02GC6.AF 0	HYNIX H5TQ1G83DFR- H9C	PASS
	1GB	DDR3 1333	SODIMM DDR3	N		HYNIX H5TQ1G83TFR- H9C	PASS
Apacer	2GB	DDR3 1333	SODIMM DDR3	N	78.A2GC9.42 00C	ELPIDA J2108BCSE-DJ-F	PASS
Apacer	4GB	DDR3 1333	SODIMM DDR3	N	78.B2GC9.AF 1	HYNIX H5TQ2G83BFR (256x8)	PASS
Apacer	4GB	DDR3 1333	SODIMM DDR3	N	78.B2GC9.42 10C	ELPIDA J2108BCSE-DJ-F	PASS
Apacer	4GB	DDR3 1333	SODIMM DDR3	N	78.B2GC9.42 10C	ELPIDA J2108ECSE-DJ-F 256x8	PASS
Apacer	8GB	DDR3 1333	SODIMM DDR3	N	78.C2GCM.4 230C	ELPIDA J4208BASE-DJ-F 512x8	PASS

DSL	2GB	DDR3 1600	SODIMM DDR3	N	D3SS56081X H12AA	SEC 113 HCK0 K4B2G0846C (256x8)	PASS
DSL	4GB	DDR3 1600	SODIMM DDR3	N	D3SS56082X H12AA	SEC 113 HCK0 K4B2G0846C (256x8)	PASS
DSL	8GB	DDR3 1333	SODIMM DDR3	N	D3SE1208XL 15AB	ELPIDA J4208EBBG-GN-F	PASS
DSL	8GB	DDR3 1600	SODIMM DDR3	N	D3SE1208XL 12AA	ELPIDA J4208EBBG-GN-F	PASS
Apacer	2GB	DDR3 1600	SODIMM DDR3	N	78.A2GCJ.AF 00C	HYNIX H5TQ2G83CFR (256x8)	PASS
Apacer	2GB	DDR3 1600	SODIMM DDR3	N	78.A2GCR.AT 00C	MICRON IYM22 D9PFJ (256x8)	PASS
Apacer	4GB	DDR3 1600	SODIMM DDR3	N	78.B2GCJ.AF 10C	HYNIX H5TQ2G83CFR (256x8)	PASS
Apacer	4GB	DDR3 1600	SODIMM DDR3	N	78.B2GCR.A F10C	HYNIX H5TC2G83EFR	PASS
Apacer	4GB	DDR3 1600	SODIMM DDR3	N	78.B2GCZ.AT 00C	MICRON 2QE22 D9QBJ	PASS
Apacer	8GB	DDR3 1600	SODIMM DDR3	N	78.C2GCZ.AT 30C	MICRON 2REI7 D9QBJ	PASS
Transcend	2GB	DDR3 1600	SODIMM DDR3	N	TS256MSK64 V6N	MICRON IVM77 D9PFJ	PASS
Transcend	4GB	DDR3 1600	SODIMM DDR3	N	TS512MSK64 V6N	MICRON 2DM77 D9PFJ 256x8	PASS
Transcend	4GB	DDR3 1600	SODIMM DDR3	N	TS512MSK64 W6H	SEC 231 HYK0 K4B4G0846B	PASS
Transcend	4GB	DDR3 1600	SODIMM DDR3	N	TS512MSK64 N6N	MICRON IRM72 D9PFJ	PASS
Transcend	8GB	DDR3 1600	SODIMM DDR3	N	TS1GSK64V6 H	MICRON IZD27 D9PBC 79T5 512x8	PASS
Transcend	8GB	DDR3 1600	SODIMM DDR3	N	TS1GSK64W 6H	SEC 231 HYK0 K4B4G0846B	PASS
ATP	8GB	DDR3 1600	SODIMM DDR3	N	AW24M64F8 BLK0S	SEC 140 HYK0 K4B4G0846B 512x8	PASS

Ordering Information

P/N	Chipset	DP	CRT	LVDS /eDP	HDMI/ DP	GbE LAN	COM	eSATA	SATA	USB 3.0/ 2.0	MiniPCIe	TPM	AMP	PCIe x16
AIMB-274G2-00A1E	Q87	1	1	1 (1)	1 (CEC)	2	2	1	4	4/6	2 (1 x F/S; 1 x H/S)	(1)	(1)	1
AIMB-274L-00A1E	Q87	0	1	0	1	1	2	0	2	4/6	1 (F/S)	0	0	1

*() BOM options available on MP version

Product Warranty (2 years)

Advantech warrants to you, the original purchaser, that each of its products will be free from defects in materials and workmanship for two years from the date of purchase.

This warranty does not apply to any products which have been repaired or altered by persons other than repair personnel authorized by Advantech, or which have been subject to misuse, abuse, accident or improper installation. Advantech assumes no liability under the terms of this warranty as a consequence of such events.

Because of Advantech's high quality-control standards and rigorous testing, most of our customers never need to use our repair service. If an Advantech product is defective, it will be repaired or replaced at no charge during the warranty period. For out-of-warranty repairs, you will be billed according to the cost of replacement materials, service time and freight. Please consult your dealer for more details.

If you think you have a defective product, follow these steps:

1. Collect all the information about the problem encountered. (For example, CPU speed, Advantech products used, other hardware and software used, etc.) Note anything abnormal and list any onscreen messages you get when the problem occurs.
2. Call your dealer and describe the problem. Please have your manual, product, and any helpful information readily available.
3. If your product is diagnosed as defective, obtain an RMA (return merchandise authorization) number from your dealer. This allows us to process your return more quickly.
4. Carefully pack the defective product, a fully-completed Repair and Replacement Order Card and a photocopy proof of purchase date (such as your sales receipt) in a shippable container. A product returned without proof of the purchase date is not eligible for warranty service.
5. Write the RMA number visibly on the outside of the package and ship it prepaid to your dealer.

Initial Inspection

Before you begin installing your motherboard, please make sure that the following materials have been shipped:

- 1 x AIMB-274 Intel Core™ i7/i5/i3 LGA1150 Mini-ITX motherboard
- 2 x SATA HDD cable (only for G2 sku)
- 2 x SATA Power cable
- 1 x Serial port cable
- 1 x I/O port bracket
- 1 x Startup manual
- 1 x Driver CD
- 1 x Warranty card

If any of these items are missing or damaged, contact your distributor or sales representative immediately. We have carefully inspected the aimb-274 mechanically and electrically before shipment. It should be free of marks and scratches and in perfect working order upon receipt. As you unpack the aimb-274, check it for signs of shipping damage. (For example, damaged box, scratches, dents, etc.) If it is damaged or it fails to meet the specifications, notify our service department or your local sales representative immediately. Also notify the carrier. Retain the shipping carton and packing material for inspection by the carrier. After inspection, we will make arrangements to repair or replace the unit.

Contents

Chapter 1	General Information	1
1.1	Introduction	2
1.2	Features	2
1.3	Specifications	2
1.3.1	System	2
1.3.2	Memory	2
1.3.3	Input/Output	2
1.3.4	Graphics.....	3
1.3.5	Ethernet LAN	3
1.3.6	Industrial features	3
1.3.7	Mechanical and environmental specifications.....	3
1.4	Jumpers and Connectors	4
	Table 1.1: Connector and Header List.....	4
	Table 1.2: Jumper List.....	5
1.5	Board layout: Jumper and Connector Locations	5
	Figure 1.1 Jumper and Connector Location	5
1.6	AIMB-274 Board Diagram	6
	Figure 1.2 AIMB-274 Board Diagram	6
1.7	Safety Precautions	6
1.8	Jumper Settings	7
1.8.1	How to Set Jumpers.....	7
1.8.2	CMOS Clear (CMOS1)	7
	Table 1.3: CMOS1.....	7
1.8.3	ME Enable/Disable Jumper (JME1).....	7
	Table 1.4: ME Enable/Disable Jumper (JME1)	7
1.8.4	Power Switch/HDD LED/SMBUS/Speaker Pin Header (JFP1)	8
	Table 1.5: Power Switch/HDD LED/SMBUS/Speaker Pin Header (JFP1).....	8
1.8.5	Power LED and Keyboard Lock Pin Header (JFP2).....	8
	Table 1.6: Power LED and Keyboard Lock Pin Header (JFP2)...	8
1.8.6	Watchdog Timer Output and OBS Beep (JWDT1+JOBS1).....	8
	Table 1.7: Watchdog Timer Output and OBS Beep (JWDT1+JOBS1).....	8
1.8.7	ATX/AT Mode Selection (PSON1).....	9
	Table 1.8: ATX/AT Mode Selection (PSON1).....	9
1.8.8	LVDS Panel Voltage Selection (JLVDS1, JLVDS2).....	9
	Table 1.9: LVDS Panel Voltage Selection (JLVDS1, JLVDS2) ...	9
1.8.9	COM1 RI# Pin RI#/5V/12V Select (JCOM1).....	9
	Table 1.10: COM1 RI# Pin RI#/5V/12V Select (JCOM1)	9
1.9	System Memory	10
1.10	Memory Installation Procedures.....	10
1.11	Cache Memory.....	10
1.12	Processor Installation.....	10
Chapter 2	Connecting Peripherals	13
2.1	Introduction	14
2.2	USB Ports (LAN1_USB12/LAN2_USB34/USB56/USB78/USB910).....	14
	Table 2.1: LAN LED Indicator.....	14
2.3	VGA Connector(VGA1)	15
2.4	Serial Ports (COM1~COM2)	16
2.5	PS/2 Keyboard and Mouse Connector (KBMS1)	17
2.6	CPU Fan Connector (CPU_FAN1).....	17
2.7	System FAN Connector (SYSFAN1/2).....	18

2.8	Power Switch/HDD LED/SMBUS/Speaker Pin Header (JFP1) & Power LED and Keyboard Lock Pin Header (JFP2)	19
2.8.1	ATX soft power switch (JFP1/PWR_SW)	19
2.8.2	Reset (JFP1/RESET).....	19
2.8.3	HDD LED (JFP1/HDDLED)	19
2.8.4	External speaker (JFP1/SPEAKER).....	19
2.8.5	Power LED and keyboard lock connector (JFP2/PWR_LED & KEY LOCK).....	20
	Table 2.2: ATX power supply LED status (No support for AT power).....	20
2.9	Display Port and HDMI Common Connector (DP-HDMI1)	20
2.10	Display Port Connector (DP2).....	21
2.11	SATA Signal Connector (SATA1 ~ SATA4) & External SATA/USB 2.0 Combo Connector (ESATA1).....	22
2.12	SATA_PWR1/2	22
2.13	HD Analog Audio Interface (AUDIO1, FPAUD1)	23
2.14	PCI-E x16 Slot (PCIEX16_1)	24
2.15	LVDS Panel Connector (LVDS1).....	24
2.16	LVDS Backlight Inverter Power Connector (INV1).....	25
2.17	Embedded Display Port Connector (EDP1), BOM optional	26
2.18	MINIPCI-E and mSATA Connector (MINIPCI-E1).....	26
2.19	MINIPCI-E Connector (MINIPCI-E2) & SIM Card Socket (SIM1).....	27
2.20	HD Digital Audio Interface (SPDIF1).....	27
2.21	Audio Amplifier Output Connector (AMP1), BOM optional	28
2.22	General Purpose I/O Pin Header (GPIO1).....	28
2.23	SPI BIOS Flash Socket (SPI1).....	29
2.24	SPI Programming Pin Header (SPI_CN1)	29
2.25	Low Pin Count Header (LPC1)	30
2.26	Case-Open Detect Connector (JCASE1).....	30
2.27	ATX 12V Power Supply Connector (ATX12V1) & ATX Power Supply Connector (ATXPWR1).....	31
2.28	Battery Holder (BAT1).....	31
2.29	CPU Socket (CPU1)	32
2.30	DDR3 SO-DIMM Socket (DIMMA1, DIMMB1).....	32

Chapter 3 BIOS Operation 33

3.1	Introduction	34
3.2	BIOS Setup	34
3.2.1	Main Menu	35
3.2.2	Advanced BIOS Features	36
3.2.3	Chipset.....	54
3.2.4	Boot	68
3.2.5	Security.....	69
3.2.6	Save & Exit	70

Chapter 4 Software Introduction & Service 71

4.1	Introduction	72
4.2	Value-Added Software Services	72
4.2.1	Software API.....	72
4.2.2	Software Utility.....	74

Chapter 5 Chipset Software Installation Utility 75

5.1	Before You Begin	76
5.2	Introduction	76
5.3	Windows 7/8 Driver Setup	77

Chapter 6	VGA Setup	79
6.1	Introduction	80
6.2	Windows 7/8	80
Chapter 7	LAN Configuration	81
7.1	Introduction	82
7.2	Features	82
7.3	Installation	82
7.4	Windows® 7/8 Driver Setup (Intel I217LM / I211AT)	83
Appendix A	I/O Pin Assignments	85
A.1	SATA Signal Connector (SATA1~SATA4)	86
	Table A.1: SATA connector (SATA1~SATA4)	86
A.2	External SATA/USB 2.0 Combo Connector (ESATA1)	86
	Table A.2: External SATA/USB 2.0 Combo Connector (ESATA1)	86
A.3	SATA Power Connector (SATA_PWR1, SATA_PWR2)	87
	Table A.3: SATA Power Connector (SATA_PWR1, SATA_PWR2)	87
A.4	MINIPCIE and mSATA Connector (MINIPCIE1)	87
	Table A.4: MINIPCIE (MINIPCIE1)	87
	Table A.5: mSATA Connector (MINIPCIE1)	88
A.5	MINIPCIE Connector (MINIPCIE2)	89
	Table A.6: MINIPCIE Connector (MINIPCIE2)	89
A.6	SIM Card Socket (SIM1)	90
	Table A.7: SIM Card Socket (SIM1)	90
A.7	Display Port and HDMI Common Connector (DP-HDMI1)	91
	Table A.8: Display Port and HDMI Common Connector (DP-HDMI1)	91
A.8	Display Port Connector (DP2)	92
	Table A.9: Display Port Connector (DP2)	92
A.9	VGA Connector (VGA1)	92
	Table A.10:VGA Connector (VGA1)	92
A.10	LVDS Panel Connector (LVDS1)	93
	Table A.11:LVDS Panel Connector (LVDS1)	93
A.11	LVDS Backlight Inverter Power Connector (INV1)	94
	Table A.12:LVDS Backlight InverterPower Connector (INV1)	94
A.12	Embedded Display Port Connector (EDP1)	94
	Table A.13:Embedded Display Port Connector (EDP1)	94
A.13	USB Header (USB56,USB78, USB910)	95
	Table A.14:USB Header (USB56, USB78, USB910)	95
A.14	RJ45+USB 3.0 Stack Connector (LAN1_USB12, LAN2_USB34)	95
	Table A.15:RJ45	95
	Table A.16:USB	96
A.15	CI-E x16 Slot (PCIEX16_1)	96
	Table A.17:PCI-E x 16 Slot (PCIEX16_1)	96
A.16	HD Digital Audio Interface (SPDIF1)	98
	Table A.18:HD Digital Audio Interface (SPDIF1)	99
A.17	HD Analog Audio Interface (AUDIO1, FPAUD1)	99
	Table A.19:AUDIO1	99
	Table A.20:FPAUD1	99
A.18	Audio Amplifier Output Connector (AMP1)	100
	Table A.21:Audio Amplifier Output Connector (AMP1)	100
A.19	General Purpose I/O Pin Header (GPIO1)	100
	Table A.22:General Purpose I/O Pin Header (GPIO1)	100

A.20	SPI BIOS Flash Socket (SPI1).....	100
	Table A.23:SPI BIOS Flash Socket (SPI1).....	101
A.21	SPI Programming Pin Header (SPI_CN1).....	101
	Table A.24:SPI Programming Pin Header (SPI_CN1).....	101
A.22	Low Pin Count Header (LPC1).....	101
	Table A.25:Low Pin Count Header (LPC1).....	101
A.23	SMBUS Programming I/F for Vcore Controller (JSMB1).....	102
	Table A.26:SMBUS Programming I/F for Vcore Controller (JSMB1)	102
A.24	Case-Open Detect Connector (JCASE1).....	102
	Table A.27:Case-Open Detect Connector (JCASE1).....	102
A.25	PS/2 Keyboard and Mouse Connector (KBMS1).....	102
	Table A.28:PS/2 Keyboard and Mouse Connector (KBMS1) ...	102
A.26	COM Port (COM1, COM2).....	103
	Table A.29:COM Port 1	103
	Table A.30:COM Port 2	103
A.27	CPU FAN Power Connector (CPUFAN1).....	104
	Table A.31:CPU FAN Power Connector (CPUFAN1).....	104
A.28	SYSTEM FAN Power Connector (SYSFAN1, SYSFAN2).....	104
	Table A.32:SYSTEM FAN Power Connector (SYSFAN1,	
	SYSFAN2).....	104
A.29	ATX 12V Power Supply Connector (ATX12V1).....	104
	Table A.33:ATX 12V Power Supply Connector (ATX12V1)	104
A.30	ATX Power Supply Connector(ATXPWR1).....	105
	Table A.34:ATX Power Supply Connector(ATXPWR1).....	105

Chapter 1

General Information

1.1 Introduction

AIMB-274 is designed with the Intel® Q87 for industrial applications that require both performance computing and enhanced power management capabilities. The motherboard supports Intel desktop Core i7-4770S 3.1GHz / Core i7-4770TE 2.3GHz / i5-4570S 2.9GHz / i5-4570TE 2.7GHz / i3-4330 3.5GHz / i3-4330TE 2.4GHz / Pentium G3420 3.2GHz/ Pentium G3320TE 2.3GHz / Xeon E3-1268L V3 2.3GHz processor up to 8 MB L3 cache and DDR3 SO-DIMM 1333/1600 up to 16GB. A rich I/O connectivity of 2 serial ports, 10 USB, dual GbE LAN, 4 SATA ports and 1 eSATA port. .

1.2 Features

- **Rich I/O connectivity:** 2 serial ports, 4 USB 3.0, 6 USB 2.0, 4 SATA 3.0, 1 eSATA, Dual GbE LAN
- **Standard Mini-ITX form factor with industrial feature:** The AIMB-274 is a full-featured Mini-ITX motherboard with balanced expandability and performance
- **Wide selection of storage devices:** SATA HDD, mSATA, eSATA, customers benefit from the flexibility of using the most suitable storage device for larger capacity
- **Optimized integrated graphic solution:** With Intel® Graphics Flexible, it supports versatile display options and 32-bit 3D graphics engine

1.3 Specifications

1.3.1 System

- **CPU:** LGA1150 Intel desktop Core i7-4770S 3.1GHz / Core i7-4770TE 2.3GHz / i5-4570S 2.9GHz / i5-4570TE 2.7GHz / i3-4330 3.5GHz / i3-4330TE 2.4GHz / Pentium G3420 3.2GHz/ Pentium G3320TE 2.3GHz / Xeon E3-1268L V3 2.3GHz
- **BIOS:** AMI EFI 64 Mbit SPI BIOS
- **System chipset:** Intel® Q87
- **SATA hard disk drive interface:**
 - Four on-board SATA connector with data transmission rate up to 600 MB
 - One eSATA on rear side with data transmission rate up to 300 MB

1.3.2 Memory

- **RAM:** Up to 16 GB in 2 slots 204-pin SODIMM sockets. Supports dual channel DDR3 1333/1600 MHz SDRAM

1.3.3 Input/Output

- **PCI bus:** 1 PCIe x16 slot
- **Serial ports:** Two serial ports, 1 x RS-232 & 1 x RS-232/422/485
- **Keyboard and PS/2 mouse connector:** Supports one standard PS/2 keyboard, one standard PS/2 mouse
- **USB port:** Supports up to ten USB ports with transmission rate up to 625 MB, 6 on board pin header with USB 2.0 and 4 external ports with USB 3.0
- **GPIO connector:** 8-bit general purpose Input/Output

1.3.4 Graphics

- **Controller:** Intel® Gfx Gen 7.5, HD graphics
- **Display memory:** 1 GB maximum shared memory with 2GB and above system memory installed
- **VGA:** Supports VGA up to resolution 1920 x 2000 @ 60 Hz refresh rate
- **LVDS:** Supports LVDS up to resolution 1920 x 1200
- **HDMI:** Supports HDMI up to resolution 4096 x 2304 @ 24Hz / 2560 x 1600 @ 60Hz
- **Displayport1.2:** Supports Display port up to resolution 3840 x 2160 @ 60Hz
- **eDP:** Supports up to resolution 3840 x 2160 @ 60Hz

1.3.5 Ethernet LAN

- Supports dual 10/100/1000 Mbps Ethernet port (s) via PCI Express x1 bus which provides 500 MB/s data transmission rate
- **Controller:** LAN1: Intel i217LM; LAN2: Intel i211AT

1.3.6 Industrial features

- **Watchdog timer:** Can generate a system reset. The watchdog timer is programmable, with each unit equal to one second or one minute (255 levels)

1.3.7 Mechanical and environmental specifications

- **Operating temperature:** 0 ~ 60° C (32 ~ 140° F, Depending on CPU)
- **Storage temperature:** -40 ~ 85° C (-40 ~ 185° F)
- **Humidity:** 5 ~ 95% non-condensing
- **Power supply voltage:** +3.3 V, +5 V, +12 V, -12 V, 5 Vsb
- **Power consumption:**
Intel Core i7-4770S 3.1GHz, 2pcs 8GB DDR3 1600MHz SDRAM, +5V @ 1.69A, +3.3V @ 0.87A, +12V @ 3.71A, 5VSB @ 0.52A
Measure the maximum current value which system under maximum load (CPU: Top speed, RAM & Graphic: Full loading)
- **Board size:** 170 mm x 170 mm (6.69" x 6.69")
- **Board weight:** 0.365 kg

1.4 Jumpers and Connectors

Connectors on the AIMB-274 motherboard link it to devices such as hard disk drives and a keyboard. In addition, the board has a number of jumpers used to configure your system for your application.

The tables below list the function of each of the board jumpers and connectors. Later sections in this chapter give instructions on setting jumpers. Chapter 2 gives instructions for connecting external devices to your motherboard.

Table 1.1: Connector and Header List

Label	Function
SATA1~SATA4	SATA Signal Connector
ESATA1	External SATA/USB 2.0 Combo Connector
SATA_PWR1, SATA_PWR2	SATA Power Connector
MINIPCIE1	MINIPCIE and mSATA Connector
MINIPCIE2	MINIPCIE Connector
SIM1	SIM Card Socket
DP-HDMI1	Display Port and HDMI Common Connector
DP2	Display Port Connector
VGA1	VGA Connector
LVDS1	LVDS Panel Connector
INV1	LVDS Backlight Inverter Power Connector
EDP1	Embedded Display Port Connector
USB56,USB78, USB910	USB Header
LAN1_USB12, LAN2_USB34	RJ45+USB 3.0 Stack Connector
PCIEX16_1	PCI-E x16 Slot
SPDIF1	HD Digital Audio Interface
AUDIO1, FPAUD1	HD Analog Audio Interface
AMP1	Audio Amplifier Output Connector
GPIO1	General Purpose I/O Pin Header
SPI1	SPI BIOS Flash Socket
SPI_CN1	SPI Programming Pin Header
LPC1	Low Pin Count Header
JSMB1	SMBUS Programming I/F for Vcore Controller
JCASE1	Case-Open Detect Connector
KBMS1	PS/2 Keyboard and Mouse Connector
COM1, COM2	COM Port
CPUFAN1	CPU FAN Power Connector
SYSFAN1, SYSFAN2	SYSTEM FAN Power Connector
ATX12V1	ATX 12V Power Supply Connector
ATXPWR1	ATX Power Supply Connector
BAT1	Battery Holder
CPU1	CPU Socket
DIMMA1, DIMMB1	DDR3 SO-DIMM Socket

Table 1.2: Jumper List

Label	Function
CMOS1	CMOS Clear Jumper
JME1	ME Enable/Disable Jumper
JFP1	Power Switch/HDD LED/SMBUS/Speaker Pin Header
JFP2	Power LED and Keyboard Lock Pin Header
JWDT1+JOBS1	Watchdog Timer Output and OBS Beep
PSO1	ATX/AT Mode Selection
JLVDS1, JLVDS2	LVDS Panel Voltage Selection
JCOM1	COM1 RI# pin RI#/5V/12V Select

1.5 Board layout: Jumper and Connector Locations

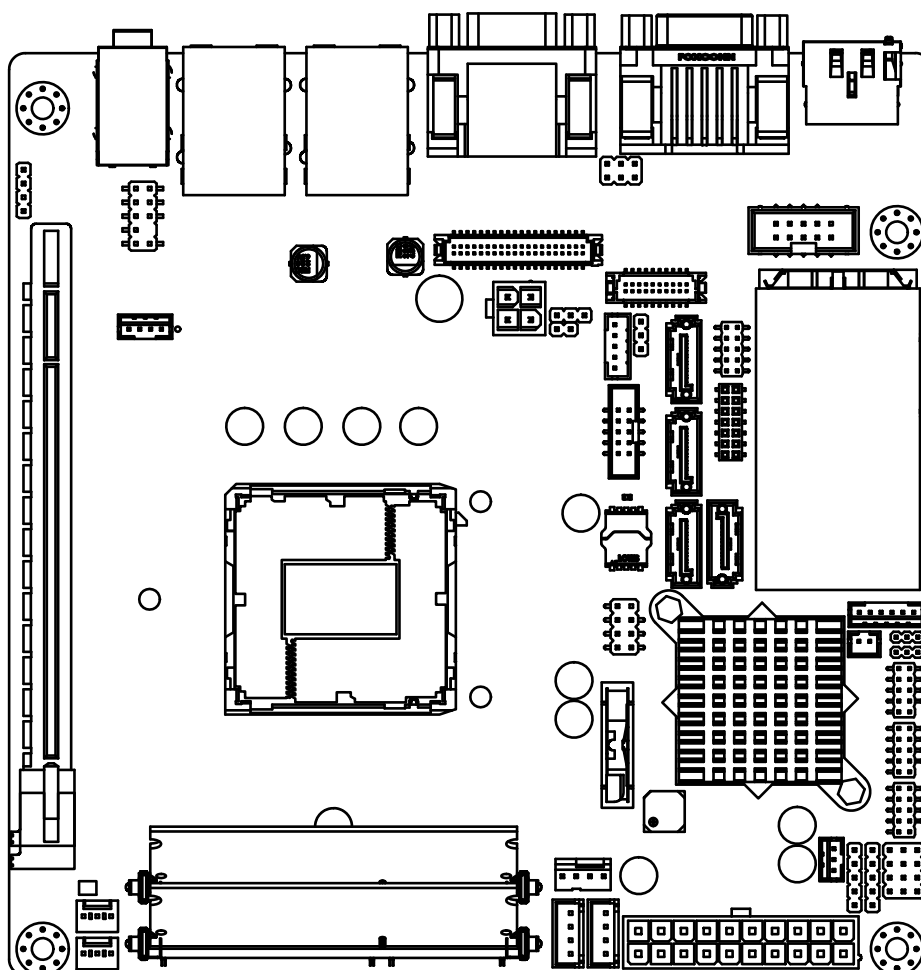

Figure 1.1 Jumper and Connector Location

1.6 AIMB-274 Board Diagram

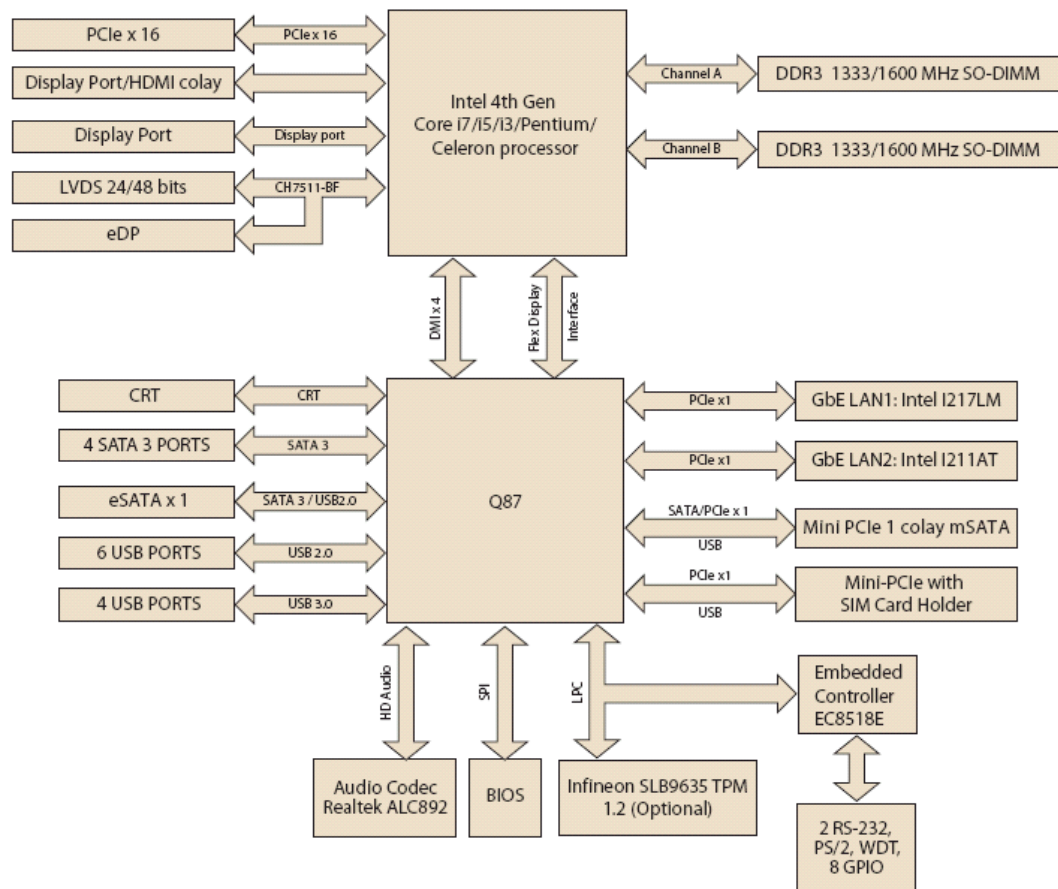

Figure 1.2 AIMB-274 Board Diagram

1.7 Safety Precautions

Warning! Always completely disconnect the power cord from chassis whenever you work with the hardware. Do not make connections while the power is on. Sensitive electronic components can be damaged by sudden power surges. Only experienced electronics personnel should open the PC chassis.



Caution! Always ground yourself to remove any static charge before touching the motherboard. Modern electronic devices are very sensitive to electrostatic discharges. As a safety precaution, use a grounding wrist strap at all times. Place all electronic components on a static-dissipative surface or in a static-shielded bag when they are not in the chassis.



Caution! The computer is provided with a battery-powered real-time clock circuit. There is a danger of explosion if battery is incorrectly replaced. Replace only with same or equivalent type recommended by the manufacturer. Discard used batteries according to manufacturer's instructions.



Caution! *There is a danger of a new battery exploding if it is incorrectly installed. Do not attempt to recharge, force open, or heat the battery. Replace the battery only with the same or equivalent type recommended by the manufacturer. Discard used batteries according to the manufacturer's instructions.*



1.8 Jumper Settings

This section provides instructions on how to configure your motherboard by setting the jumpers. It also includes the motherboards's default settings and your options for each jumper.



1.8.1 How to Set Jumpers

You can configure your motherboard to match the needs of your application by setting the jumpers. A jumper is a metal bridge that closes an electrical circuit. It consists of two metal pins and a small metal clip (often protected by a plastic cover) that slides over the pins to connect them. To “close” (or turn ON) a jumper, you connect the pins with the clip. To “open” (or turn OFF) a jumper, you remove the clip. Sometimes a jumper consists of a set of three pins, labeled 1, 2, and 3. In this case you connect either pins 1 and 2, or 2 and 3. A pair of needle-nose pliers may be useful when setting jumpers.

1.8.2 CMOS Clear (CMOS1)

The AIMB-274 motherboard contains a jumper that can erase CMOS data and reset the system BIOS information. Normally this jumper should be set with pins 1-2 closed. If you want to reset the CMOS data, set CMOS1 to 2-3 closed for just a few seconds, and then move the jumper back to 1-2 closed. This procedure will reset the CMOS to its default setting.

Table 1.3: CMOS1

Function	Jumper Setting			
	1	2	3	
*Keep CMOS data				1-2 closed
Clear CMOS data				2-3 closed

* Default

1.8.3 ME Enable/Disable Jumper (JME1)

Table 1.4: ME Enable/Disable Jumper (JME1)

Function	Jumper Setting			
	1	2	3	
EnableME (Default)				1-2 closed

Table 1.4: ME Enable/Disable Jumper (JME1)



1.8.4 Power Switch/HDD LED/SMBUS/Speaker Pin Header (JFP1)

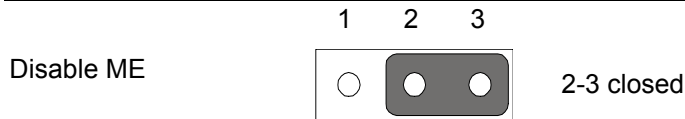
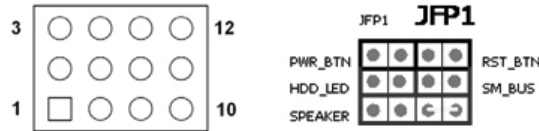

Table 1.5: Power Switch/HDD LED/SMBUS/Speaker Pin Header (JFP1)

Pin	Signal	Pin	Signal
1	+5V	2	HDDLED+
3	Power Button+	4	NC
5	HDDLED-	6	Power Button-
7	SPK_P3	8	SMB_DATA
9	System Reset+	10	SPK_P4
11	SMB_CLK	12	System Reset-

1.8.5 Power LED and Keyboard Lock Pin Header (JFP2)

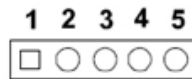

Table 1.6: Power LED and Keyboard Lock Pin Header (JFP2)

Pin	Signal
1	LED Power
2	NC
3	GND
4	Keyboard LOCK#
5	GND

1.8.6 Watchdog Timer Output and OBS Beep (JWDT1+JOBS1)

Table 1.7: Watchdog Timer Output and OBS Beep (JWDT1+JOBS1)

Function	Jumper Setting
----------	----------------

Watchdog Timer Output(2-3) (Default)
OBS BEEP(4-5) (Default)

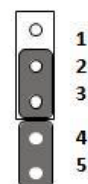

(2 and 3)+(4 and 5)

Table 1.7: Watchdog Timer Output and OBS Beep (JWDT1+JOBS1)



1.8.7 ATX/AT Mode Selection (PSON1)

Table 1.8: ATX/AT Mode Selection (PSON1)

Function	Jumper Setting			
	1	2	3	
AT Mode				1-2 closed
ATX Mode (Default)				2-3 closed

1.8.8 LVDS Panel Voltage Selection (JLVDS1, JLVDS2)

Table 1.9: LVDS Panel Voltage Selection (JLVDS1, JLVDS2)

Function	Jumper Setting
Jumper position for 5V	 JLVDS1.2 and JLVDS1.3
Jumper position for 3.3V (Default)	 JLVDS1.1 and JLVDS1.2
Jumper position for 12V	 JLVDS1.2 and JLVDS2.2

1.8.9 COM1 RI# Pin RI#/5V/12V Select (JCOM1)

Table 1.10: COM1 RI# Pin RI#/5V/12V Select (JCOM1)

Function	Jumper Setting
Jumper position for RI#(Default)	 1 and 2

Table 1.10: COM1 RI# Pin RI#/5V/12V Select (JCOM1)

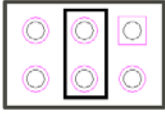
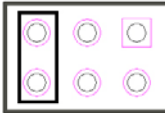
Jumper position for 5V		3 and 4
Jumper position for 12V		5 and 6

1.9 System Memory

AIMB-274 has two sockets for a 204-pin DDR3 SODIMM. This socket uses a 1.5 V unbuffered double data rate synchronous DRAM (DDR SDRAM). DRAM is available in capacities of 1 GB, 2 GB, 4 GB and 8 GB. The sockets can be filled in any combination with SODIMMs of any size, giving a total memory size between 1 GB, 2 GB, 4 GB, 8 GB and 16 GB. AIMB-274 does NOT support ECC (error checking and correction).

1.10 Memory Installation Procedures

To install SODIMMs, first make sure the two handles of the SODIMM socket are in the “open” position, i.e., the handles lean outward. Slowly slide the SODIMM module along the plastic guides on both ends of the socket. Then firmly but gently (avoid pushing down too hard) press the SODIMM module well down into the socket, until you hear a click when the two handles have automatically locked the memory module into the correct position of the SODIMM socket. To remove the memory module, just push both handles outward, and the memory module will be ejected by the mechanism.

1.11 Cache Memory

The AIMB-274 supports a CPU with one of the following built-in full speed Last Level Cache:

8MB for Intel Xeon E3-1268L V3

8MB for Intel Core i7-4770S

8MB for Intel Core i7-4770TE

6MB for Intel Core i5-4570S

4MB for Intel Cpre i5-4570TE

3MB for Intel Core i3-4330

3MB for Intel Core i3-4330TE

3MB for Intel Pentium G3420

3MB for Intel Pentium G3320TE

The built-in second-level cache in the processor yields much higher performance than conventional external cache memories.

1.12 Processor Installation

The AIMB-274 is designed for LGA1150, Xeon, Core i7/Core i5/Core i3, Pentium, Celeron processor.

Chapter 2

Connecting
Peripherals

2.1 Introduction

You can access most of the connectors from the top of the board as it is being installed in the chassis. If you have a number of cards installed or have a packed chassis, you may need to partially remove the card to make all the connections.

2.2 USB Ports (LAN1_USB12/LAN2_USB34/USB56/USB78/USB910)

The AIMB-274 provides up to ten USB ports. Four USB3.0 on the rear side and six pin header on the board. The USB interface complies with USB Specification Rev. 2.0 and Rev. 3.0 supporting transmission rates up to 625 Mbps and is fuse protected. The USB interface can be disabled in the system BIOS setup.

The AIMB-274 is equipped with two high-performance 1000 Mbps Ethernet LAN adapter, which are supported by all major network operating systems. The RJ-45 jacks on the rear panel provides for convenient LAN connection.

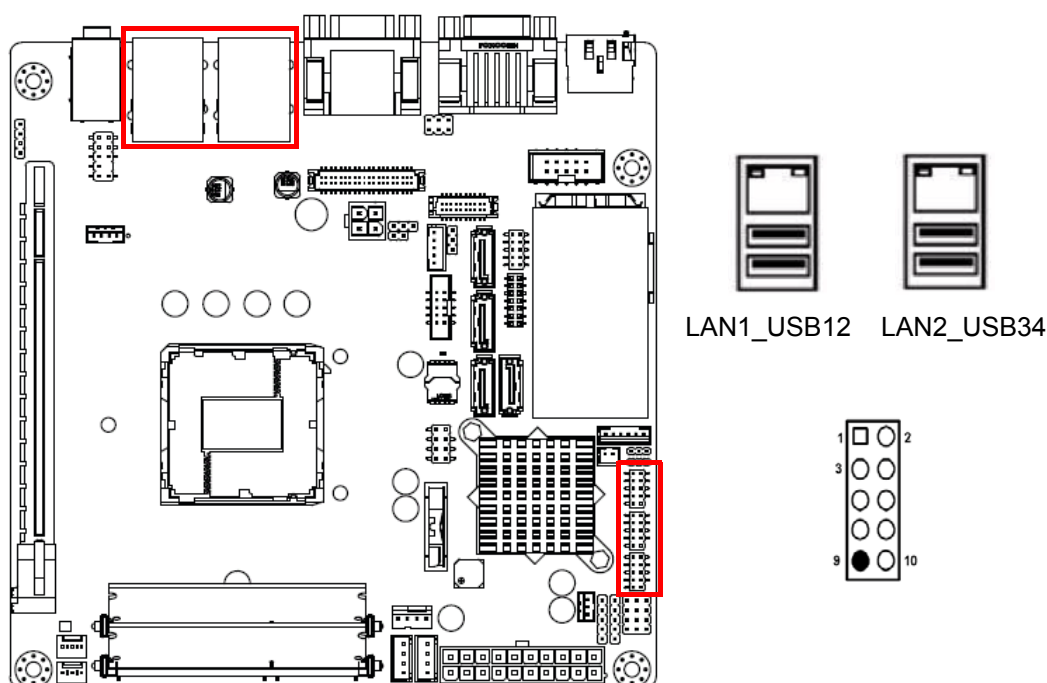
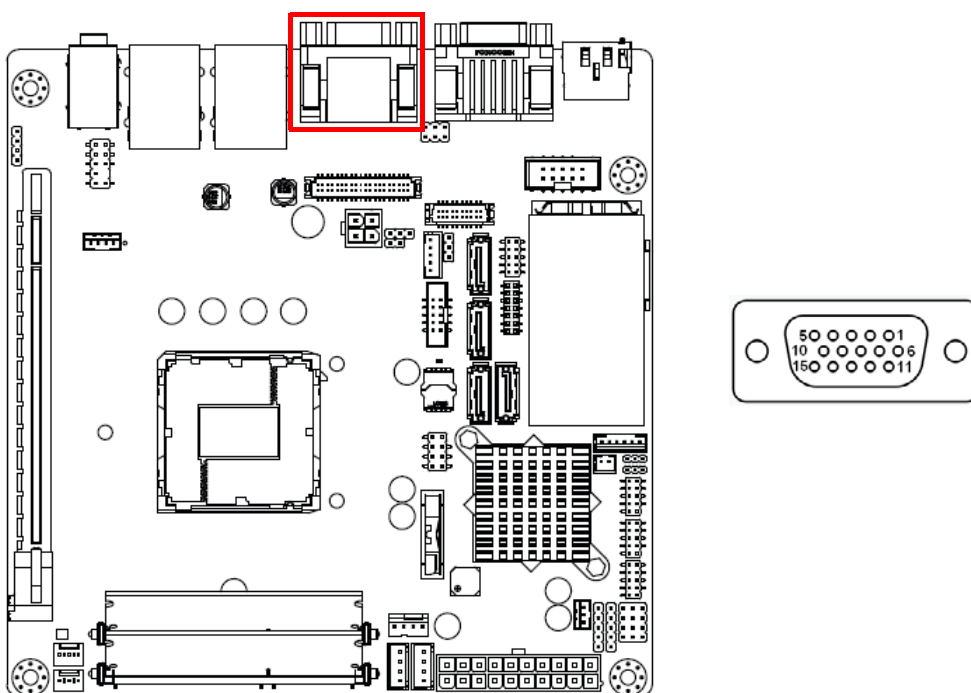

Table 2.1: LAN LED Indicator

LAN Mode	LAN Indicator	
LAN1 indicator	LED1 (Right)	off for mal-link; Link (On) / Active (Flash)
	LED2 (Left)	100 Mbps (On) / 10 Mbps (Off)
	LED2 (Left)	1000 Mbps (On)
LAN2 indicator	LED1 (Right)	off for mal-link; Link (On) / Active (Flash)
	LED2 (Left)	100 Mbps (On) / 10 Mbps (Off)
	LED2 (Left)	1000 Mbps (On)

2.3 VGA Connector(VGA1)



The AIMB-274 includes VGA interface that can drive conventional VGA displays. VGA1 is a standard 15-pin D-SUB connector commonly used for VGA.

2.4 Serial Ports (COM1~COM2)

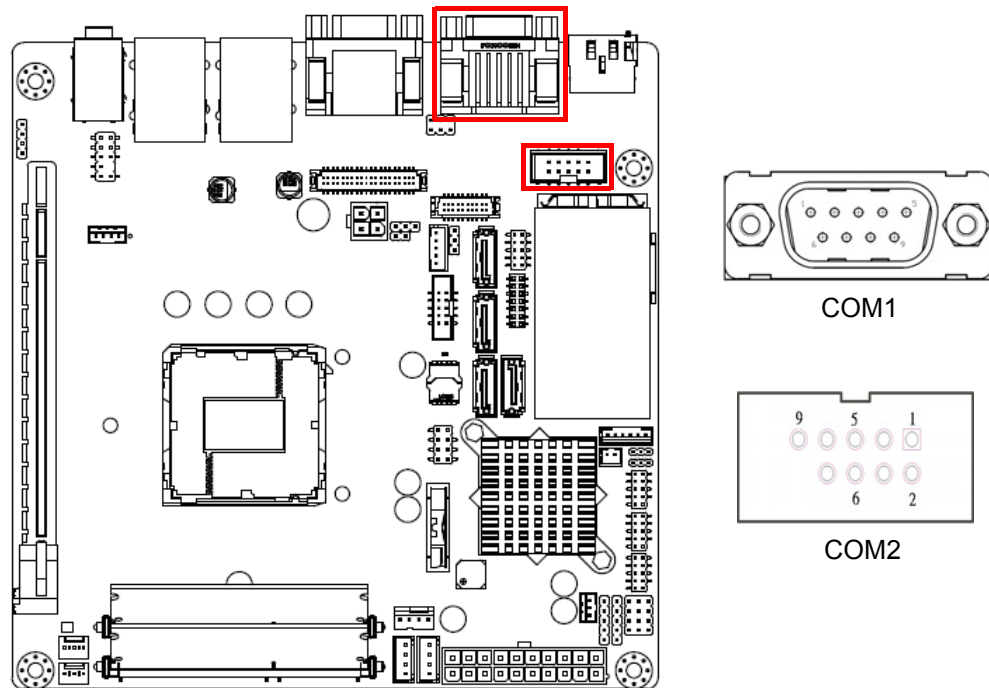

AIMB-274 supports two serial ports, COM1 supports RS-232 function, COM2 supports RS-232/422/485 function by BIOS selection.

These ports can connect to serial devices, such as a mouse or a printer, or to a communications network.

The IRQ and address ranges for both ports are fixed. However, if you want to disable the port or change these parameters later, you can do this in the system BIOS setup.

Different devices implement the RS-232 standards in different ways. If you have problems with a serial device, be sure to check the pin assignments for the connector.

2.5 PS/2 Keyboard and Mouse Connector (KBMS1)

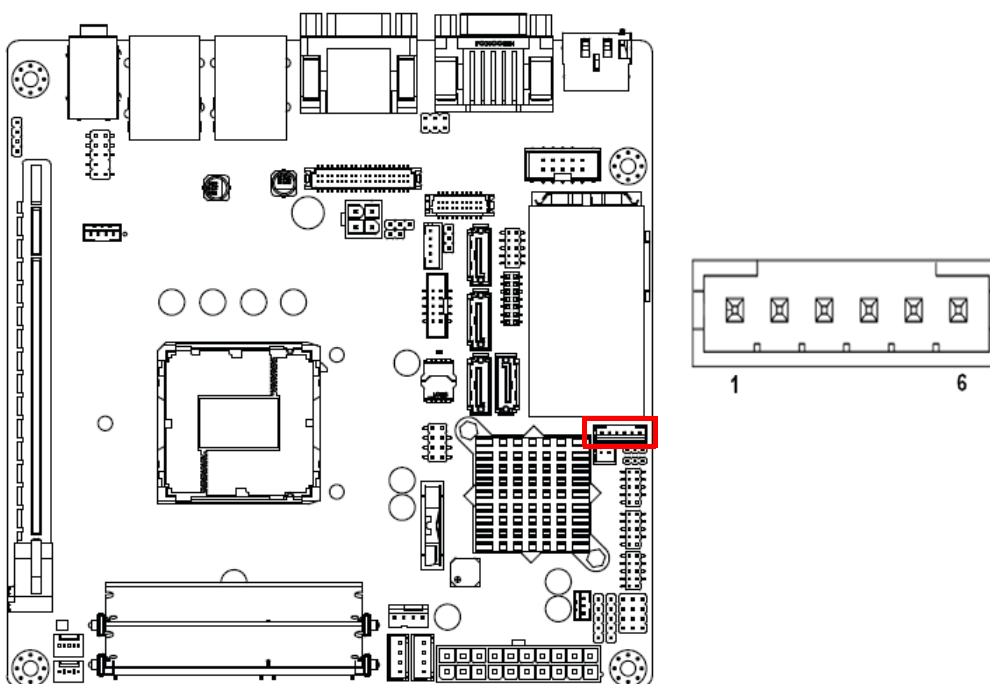

On board 6-pin wafer box connector, supports one standard PS/2 keyboard, one standard PS/2 mouse.

2.6 CPU Fan Connector (CPU_FAN1)

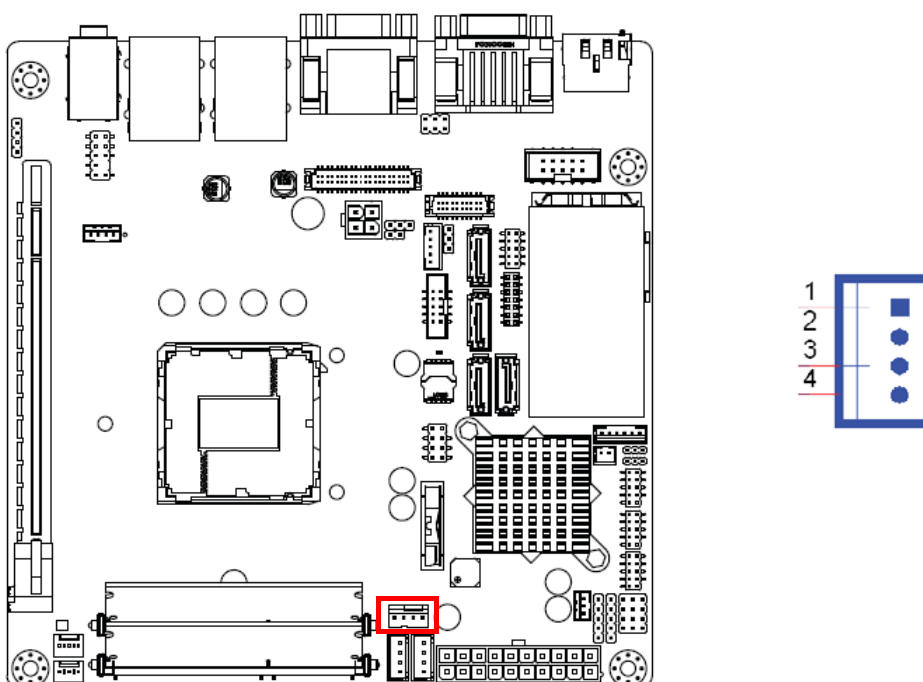

If a fan is used, this connector supports cooling fans of 500 mA (6 W) or less.

2.7 System FAN Connector (SYSFAN1/2)

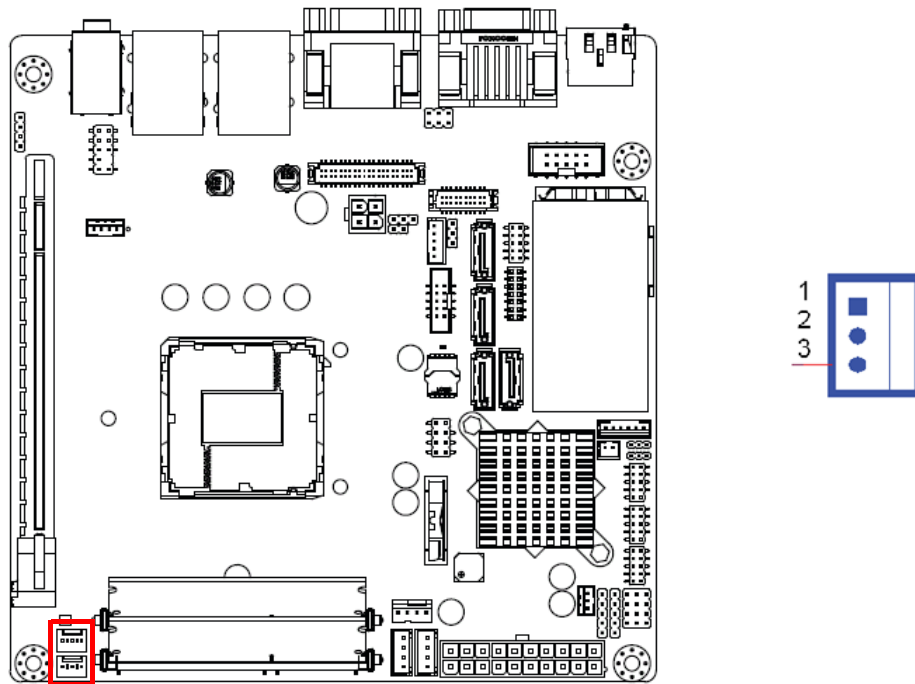

If a fan is used, this connector supports cooling fans of 500 mA (6 W) or less.

2.8 Power Switch/HDD LED/SMBUS/Speaker Pin Header (JFP1) & Power LED and Keyboard Lock Pin Header (JFP2)

There are several headers for monitoring and controlling the AIMB-274.

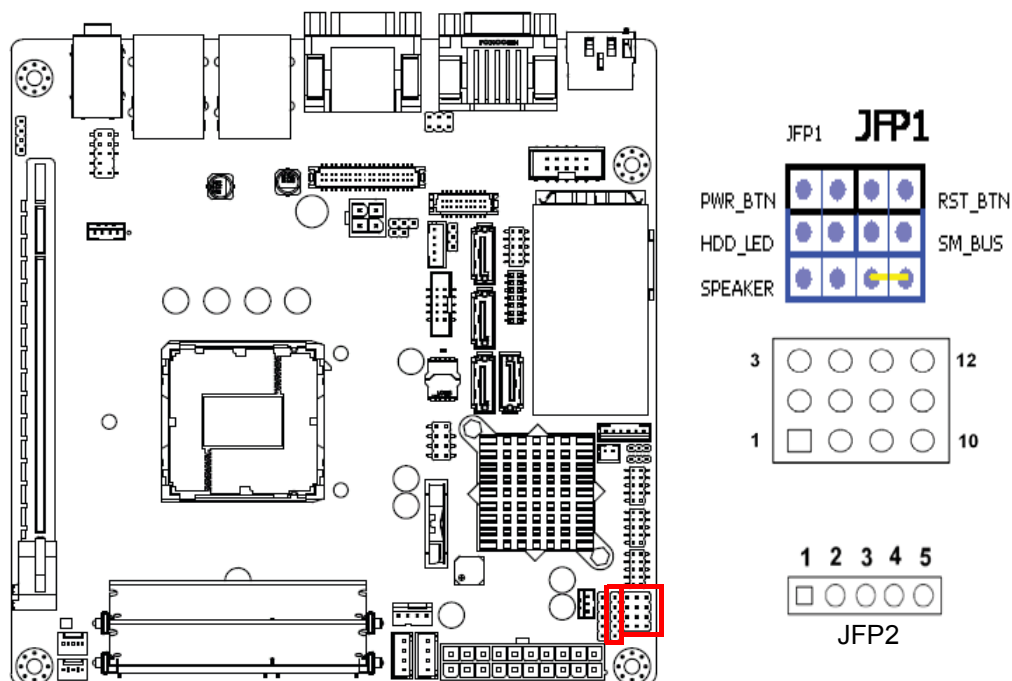

2.8.1 ATX soft power switch (JFP1/PWR_SW)

If your computer case is equipped with an ATX power supply, you should connect the power on/off button on your computer case to (JFP1/ PWR_SW), for convenient power on and off.

2.8.2 Reset (JFP1/RESET)

Many computer cases offer the convenience of a reset button. Connect the wire for the reset button.

2.8.3 HDD LED (JFP1/HDDLED)

You can connect an LED to connector (JFP1/HDDLED) to indicate when the HDD is active.

2.8.4 External speaker (JFP1/SPEAKER)

JFP1/SPEAKER is a 4-pin connector for an external speaker. If there is no external speaker, the AIMB-274 provides an onboard buzzer as an alternative. To enable the buzzer, set pins 7 & 10 as closed.

2.8.5 Power LED and keyboard lock connector (JFP2/PWR_LED & KEY LOCK)

(JFP2/PWR_LED & KEY LOCK) is a 5-pin connector for the power on LED and Key Lock function. Refer to Appendix B for detailed information on the pin assignments. The Power LED cable should be connected to pin 1-3. The key lock button cable should be connected to pin 4-5. There are 3 modes for the power supply connection. The first is “ATX power mode”; the system turns on/off by a momentary power button. The second is “AT Power Mode”; the system turns on/off via the power supply switch. The third is another “AT Power Mode” which makes use of the front panel power switch. The power LED status is indicated in the following table:

Table 2.2: ATX power supply LED status (No support for AT power)

Power mode	LED (ATX Power Mode) (On/off by momentary button)	LED (AT power Mode) (On/off by switching power supply)	LED (AT power Mode) (On/off by front panel switch)
PSOEN1 (on back plane) jumper setting	pins 2-3 closed	pins 1-2 closed	Connect pins 1 & 2 to panel switch via cable
System On	On	On	On
System Suspend	Fast flashes	Fast flashes	Fast flashes
System Off	Slow flashes	Off	Off

2.9 Display Port and HDMI Common Connector (DP-HDMI1)

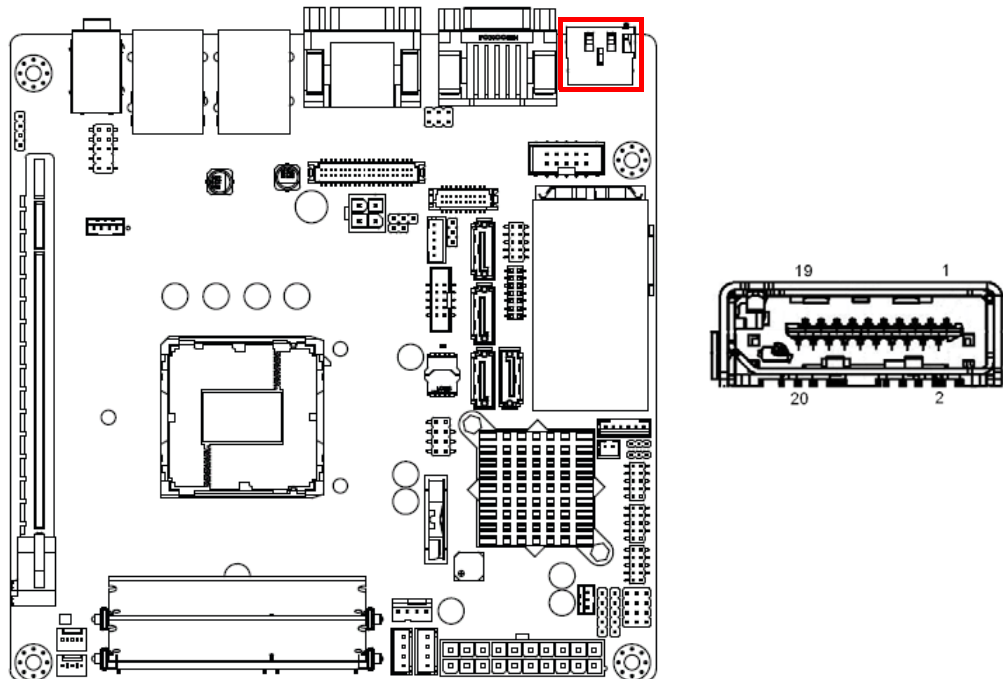

Note! *NOTE: When using HDMI cable in the dual DisplayPort/HMI connector, make sure to plug in the HDMI connector "to the right side", to prevent wrong placement.*

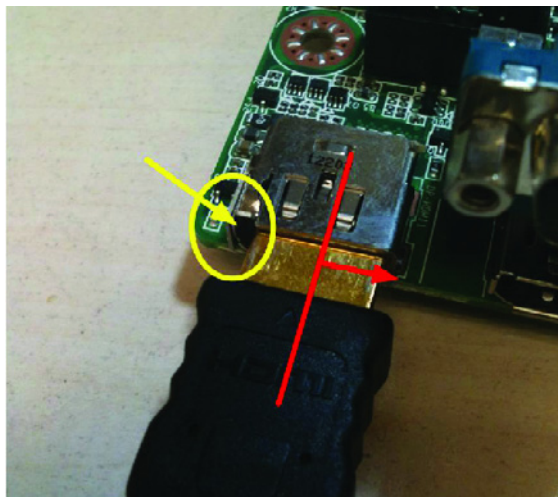

2.10 Display Port Connector (DP2)

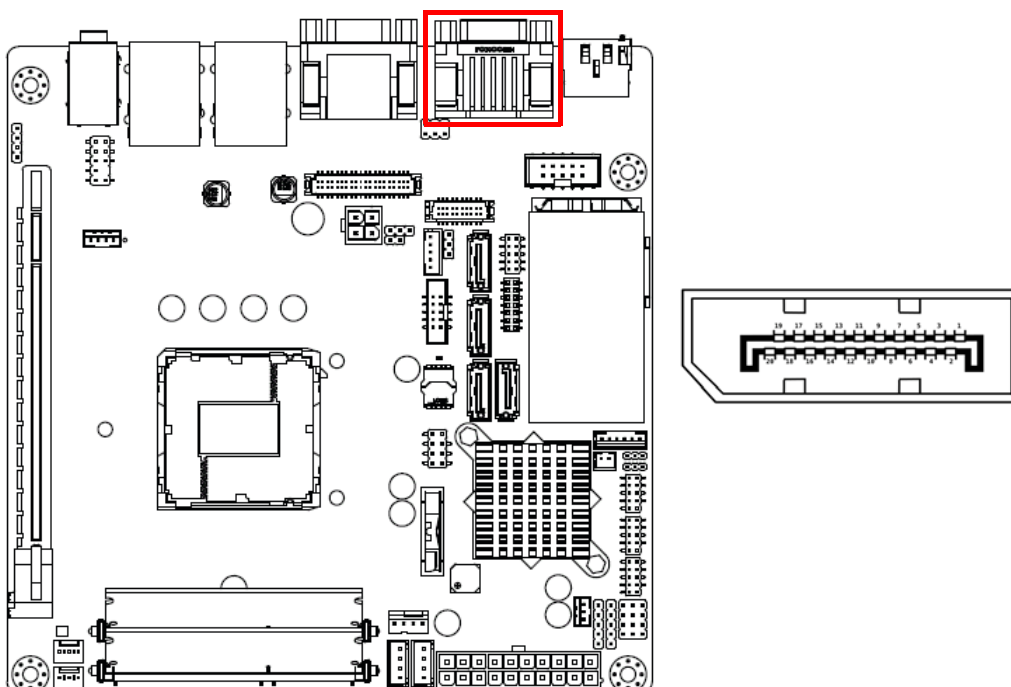

2.11 SATA Signal Connector (SATA1 ~ SATA4) & External SATA/USB 2.0 Combo Connector (ESATA1)

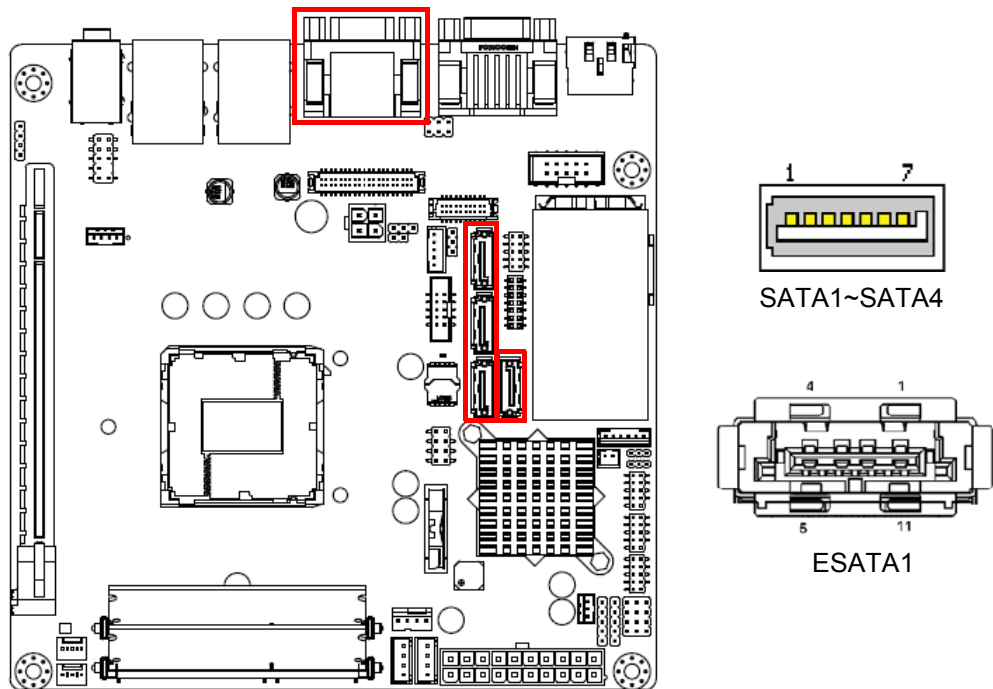

AIMB-274 features a high performance Serial ATA III interface (up to 600 MB/s) which eases hard drive cabling with thin, space-saving cables.

2.12 SATA_PWR1/2

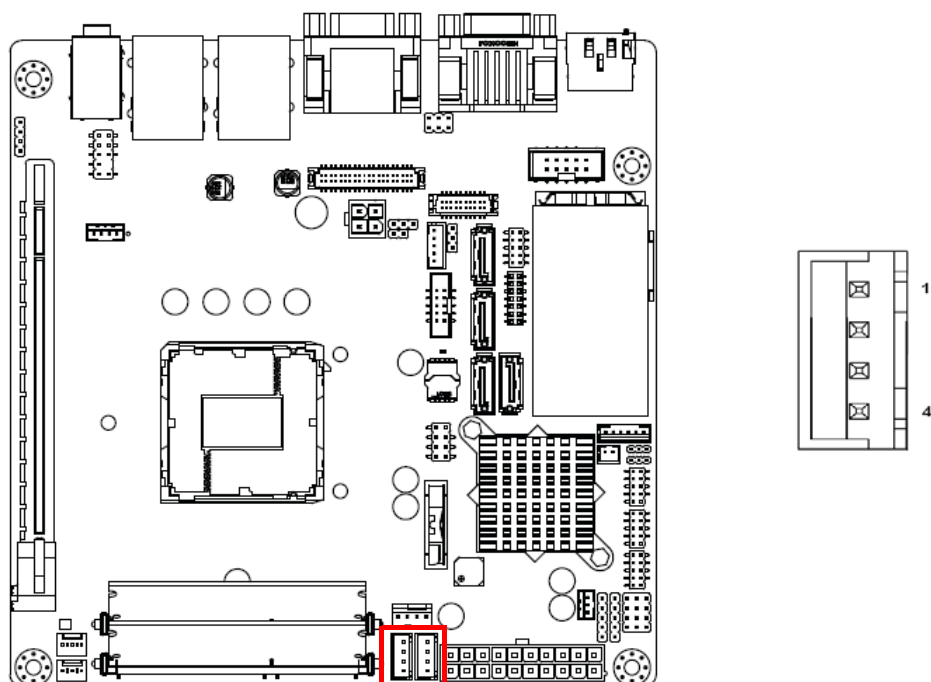

2.13 HD Analog Audio Interface (AUDIO1, FPAUD1)

Front headphone connector (FPAUD1) is for a chassis-mounted front panel audio I/O module that supports either HD Audio or legacy AC'97 (optional) audio standard. Connect this connector with the front panel audio I/O module cable.

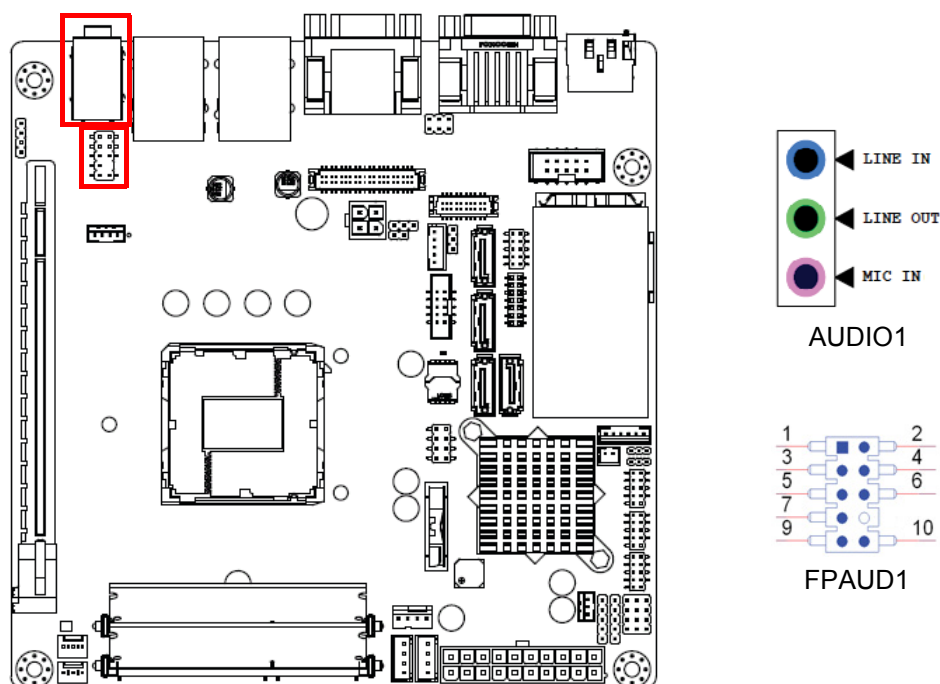

Note! For motherboards with the optional HD Audio feature, we recommend that you connect a high-definition front panel audio module to this connector to take advantage of the motherboard's high definition audio capability.



2.14 PCI-E x16 Slot (PCIEX16_1)

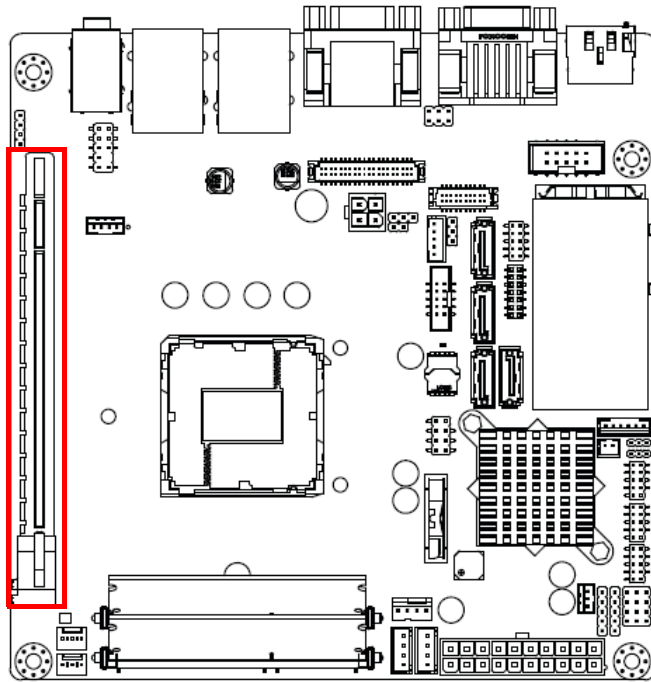

AIMB-274 provides 1 x PCI express x16 slot.

2.15 LVDS Panel Connector (LVDS1)

The SPI flash card pin header may be used to flash BIOS if the AIMB-274 cannot power on.

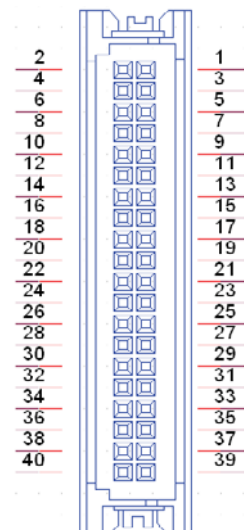
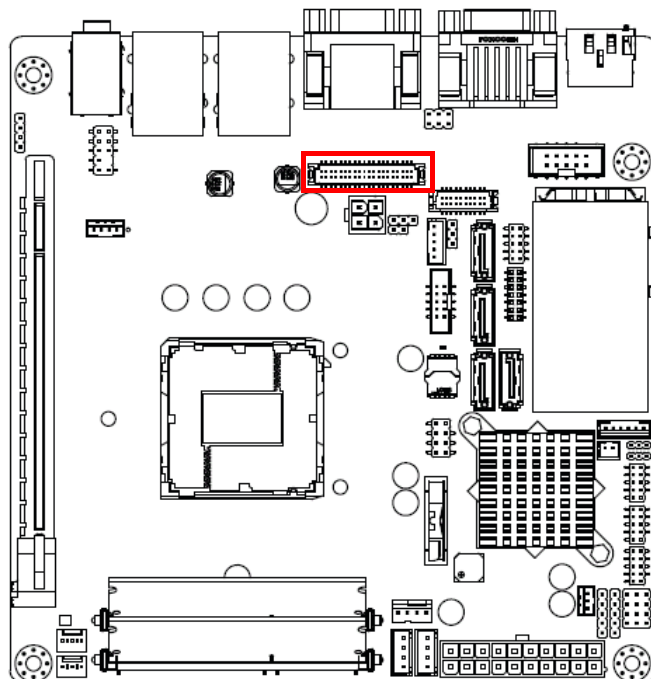

2.16 LVDS Backlight Inverter Power Connector (INV1)

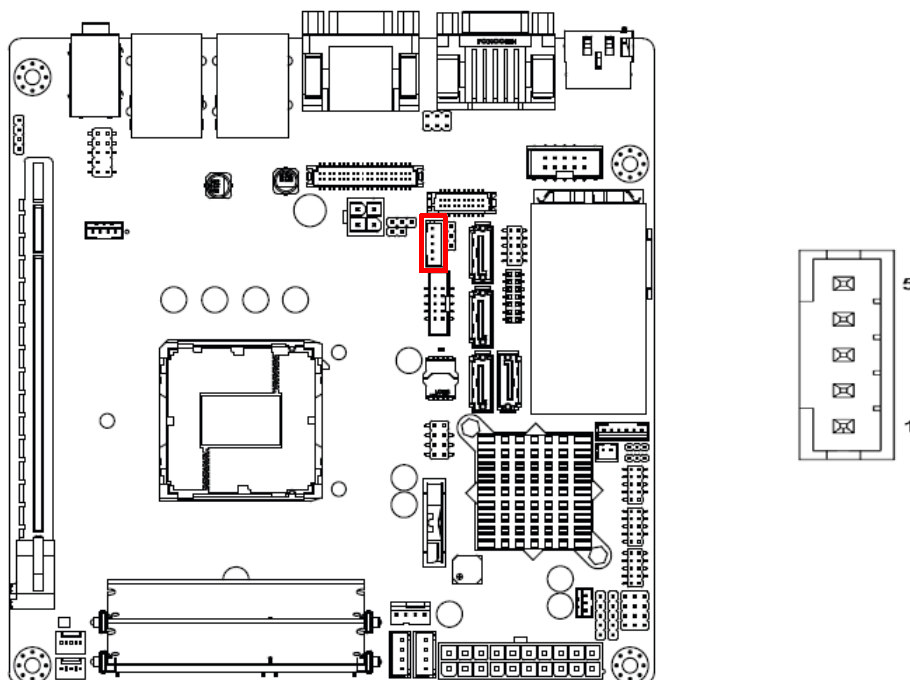

Note! ■ Signal Description



Signal

VR

ENBKL

Signal Description

$V_{adj}=0.75\text{ V}$

(Recommended: $4.7\text{ K}\Omega$, $>1/16\text{ W}$)

LCD backlight ON/OFF control signal

2.17 Embedded Display Port Connector (EDP1), BOM optional

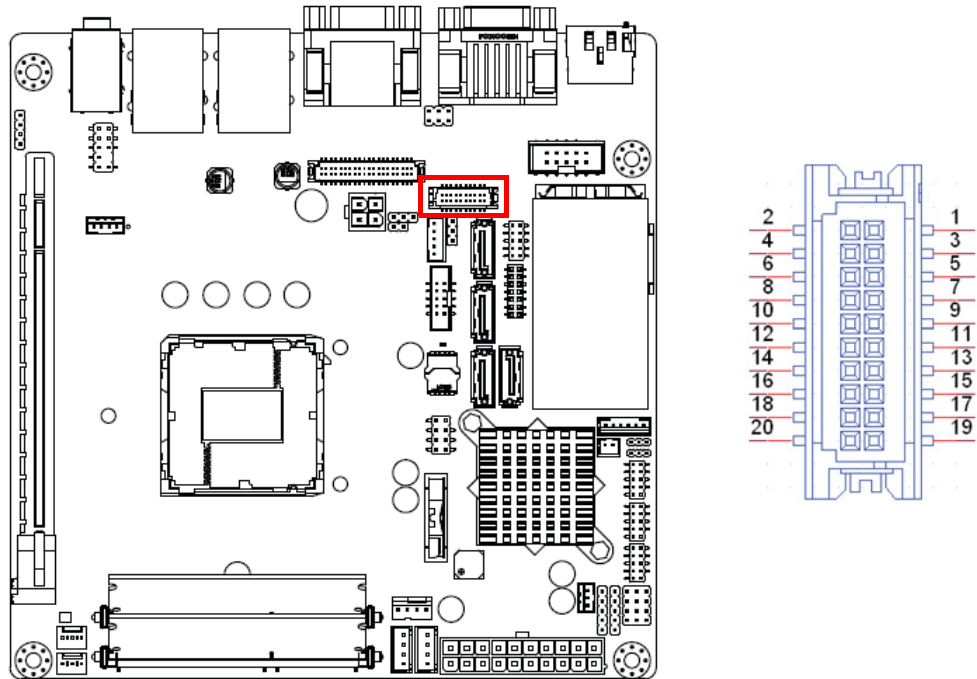

2.18 MINIPCIIE and mSATA Connector (MINIPCIIE1)

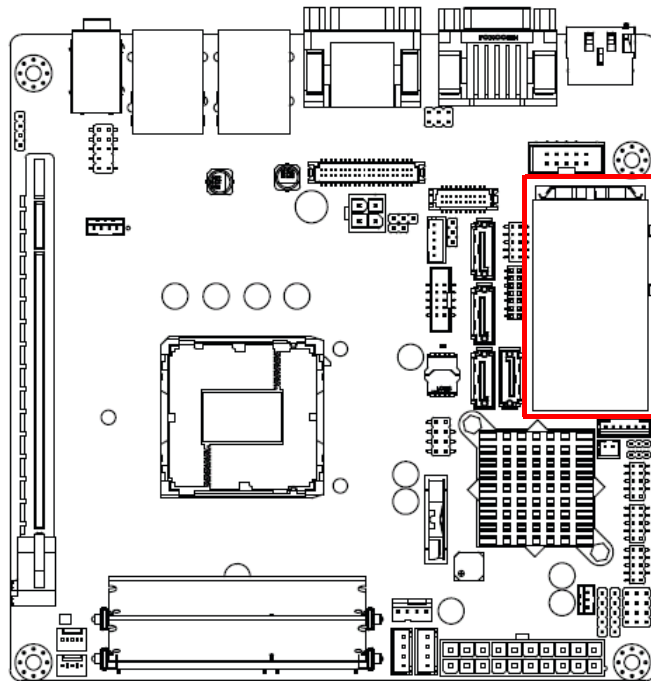

2.19 MINIPCIE Connector (MINIPCIE2) & SIM Card Socket (SIM1)

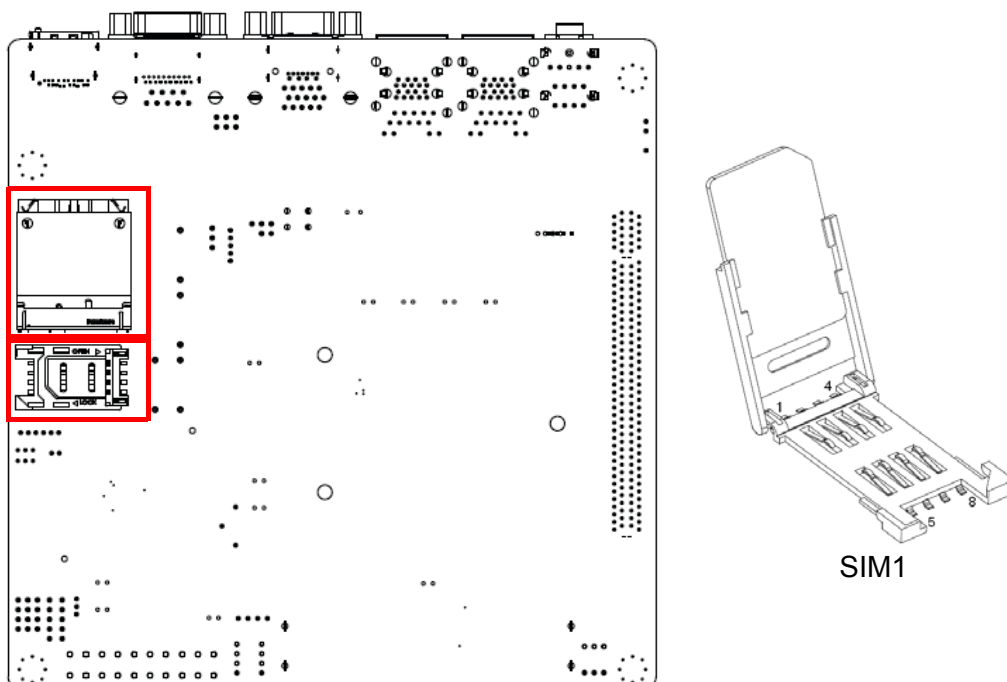

2.20 HD Digital Audio Interface (SPDIF1)

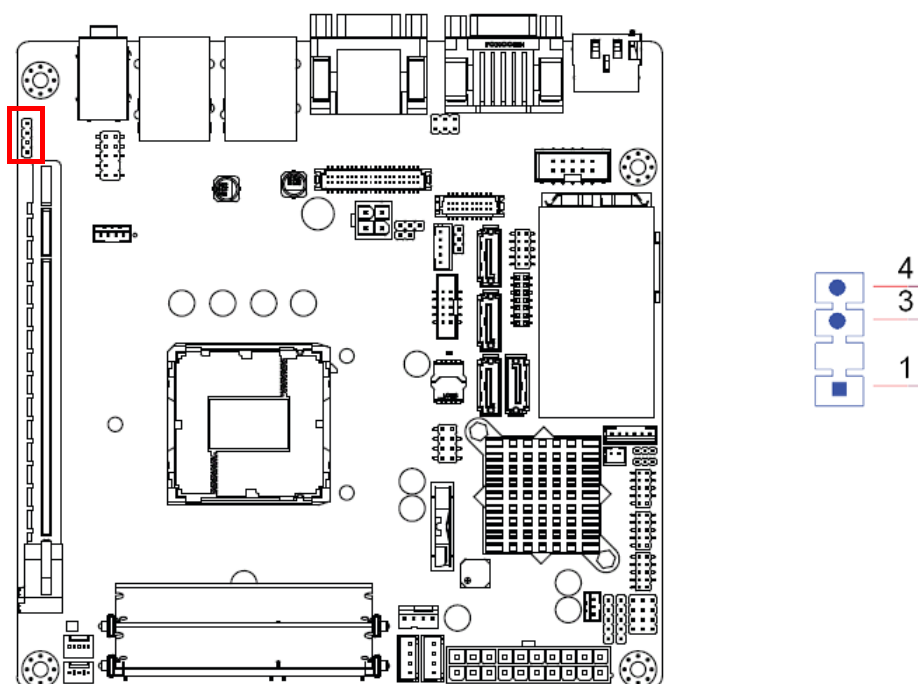

2.21 Audio Amplifier Output Connector (AMP1), BOM optional

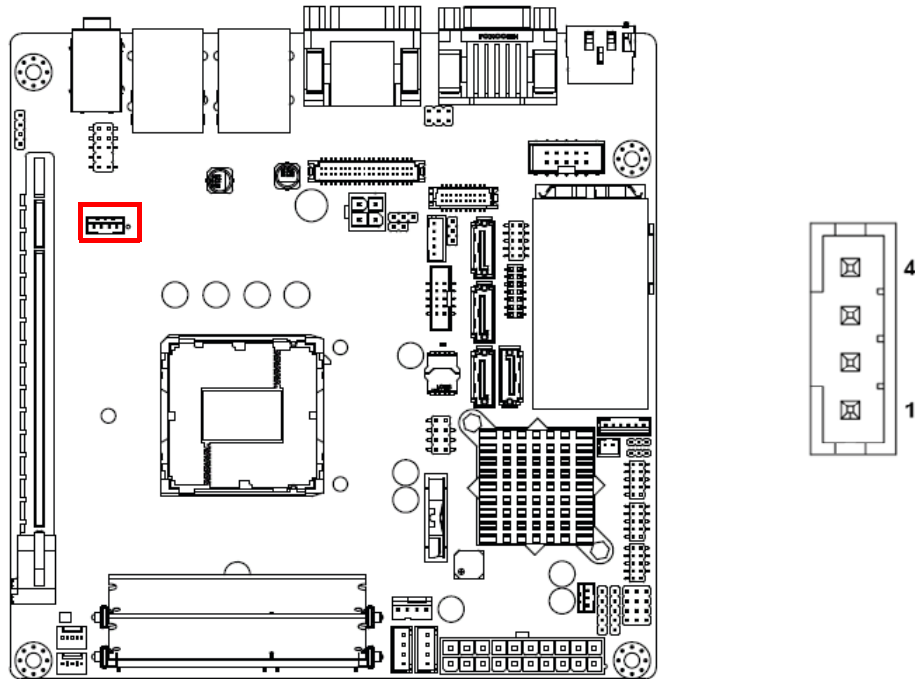

2.22 General Purpose I/O Pin Header (GPIO1)

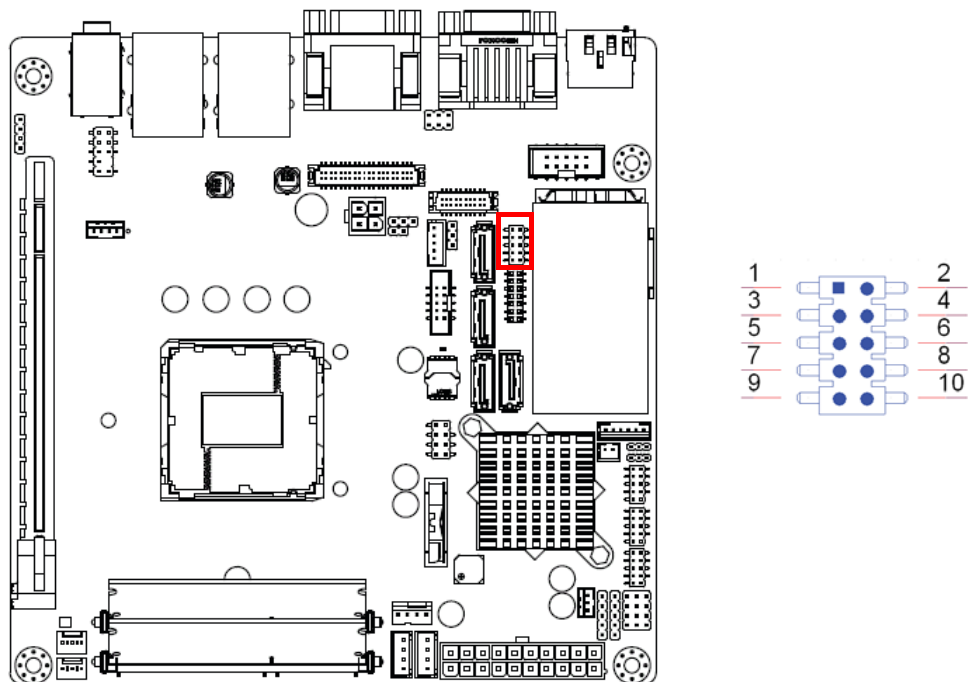

2.23 SPI BIOS Flash Socket (SPI1)

The SPI flash card pin header may be used to flash BIOS if the AIMB-274 cannot power on.

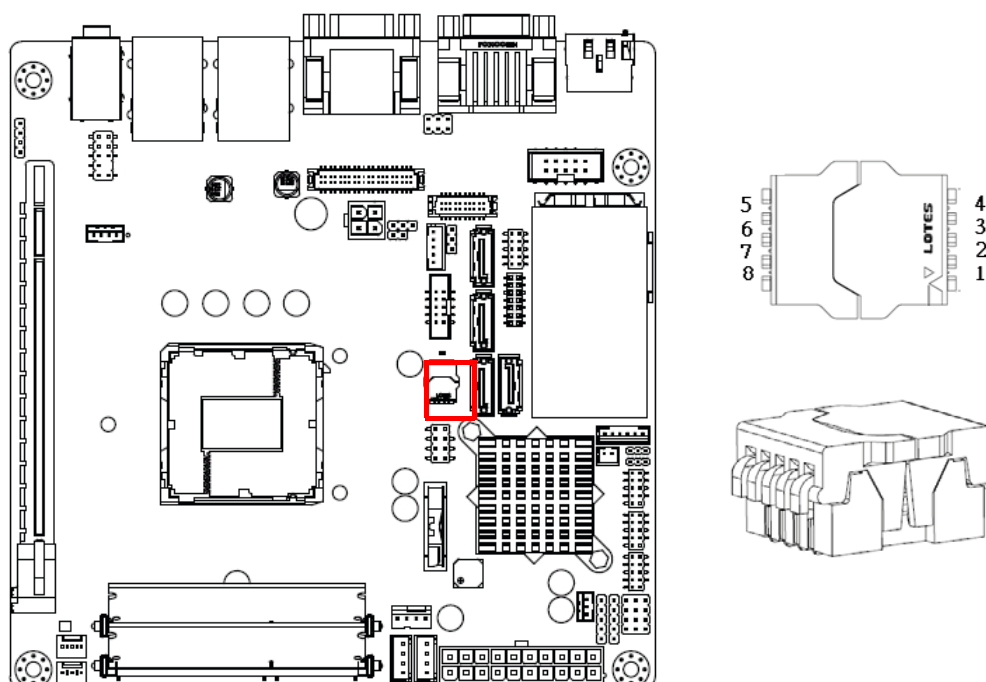

2.24 SPI Programming Pin Header (SPI_CN1)

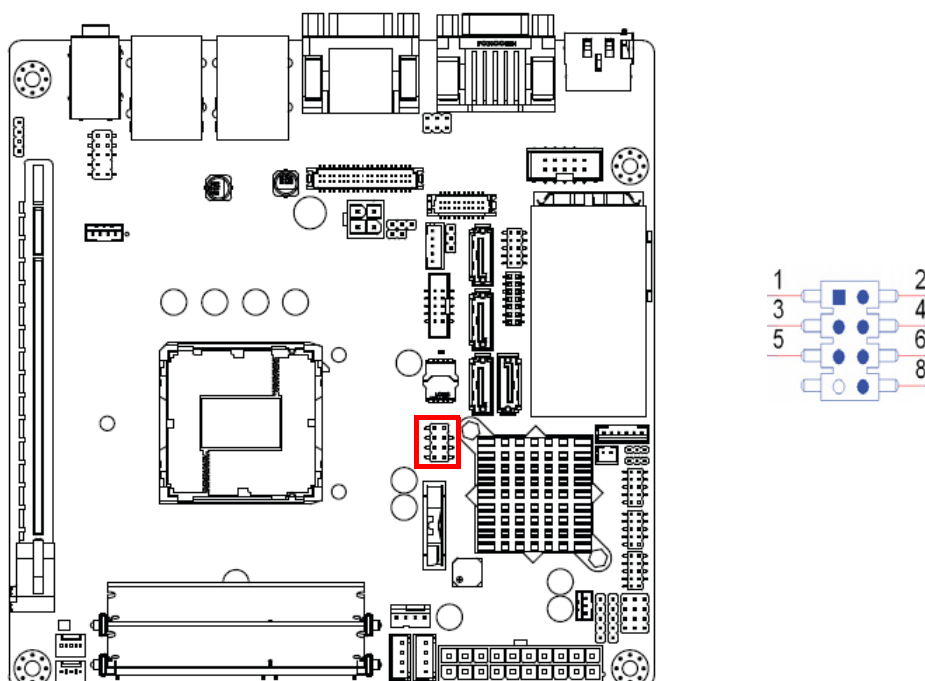

2.25 Low Pin Count Header (LPC1)

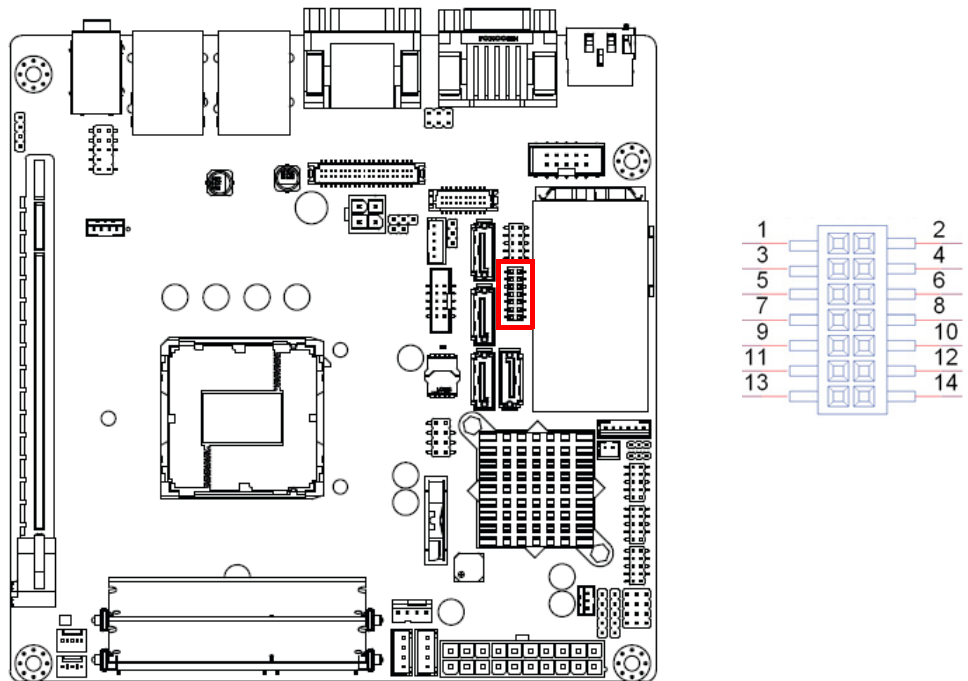

2.26 Case-Open Detect Connector (JCASE1)

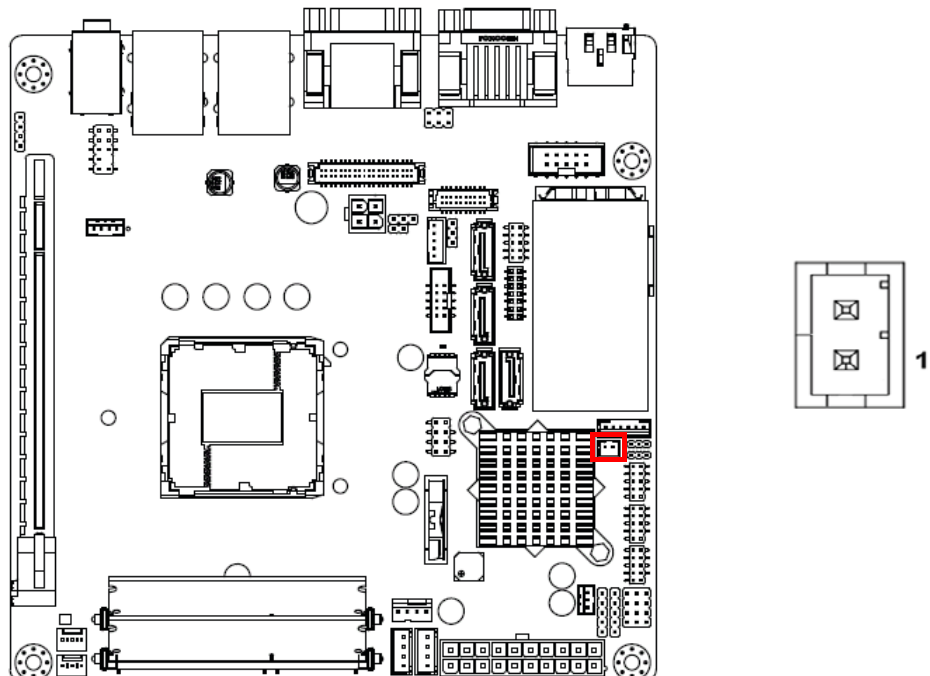

2.27 ATX 12V Power Supply Connector (ATX12V1) & ATX Power Supply Connector (ATXPWR1)

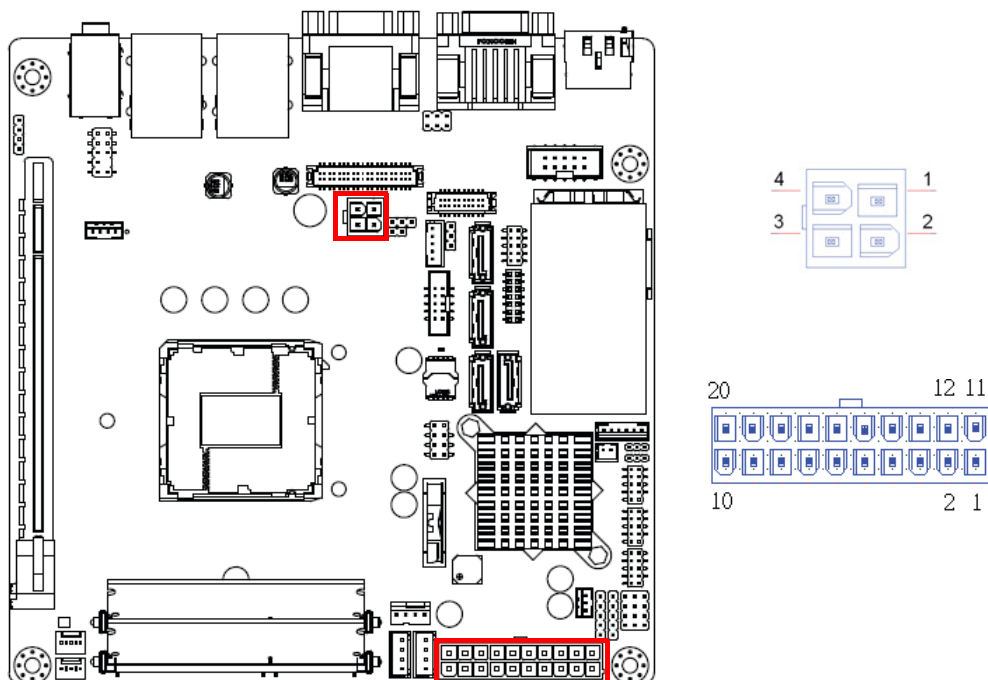

2.28 Battery Holder (BAT1)

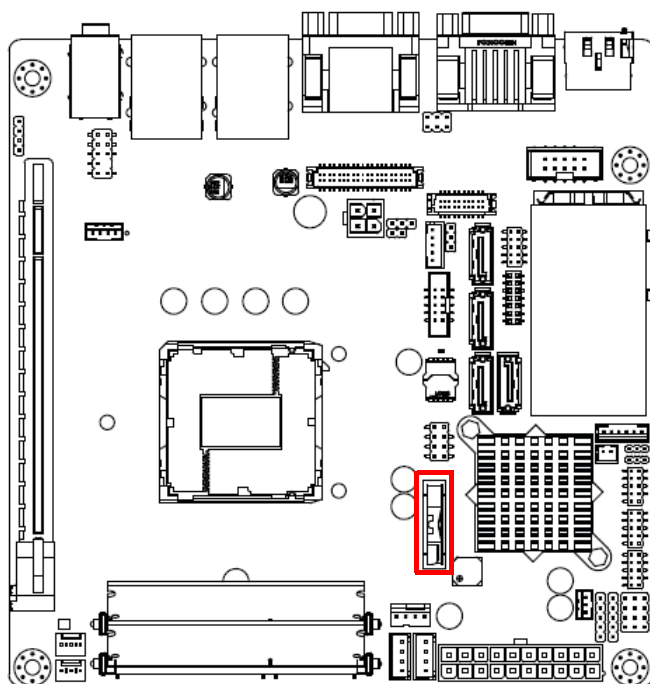

2.29 CPU Socket (CPU1)

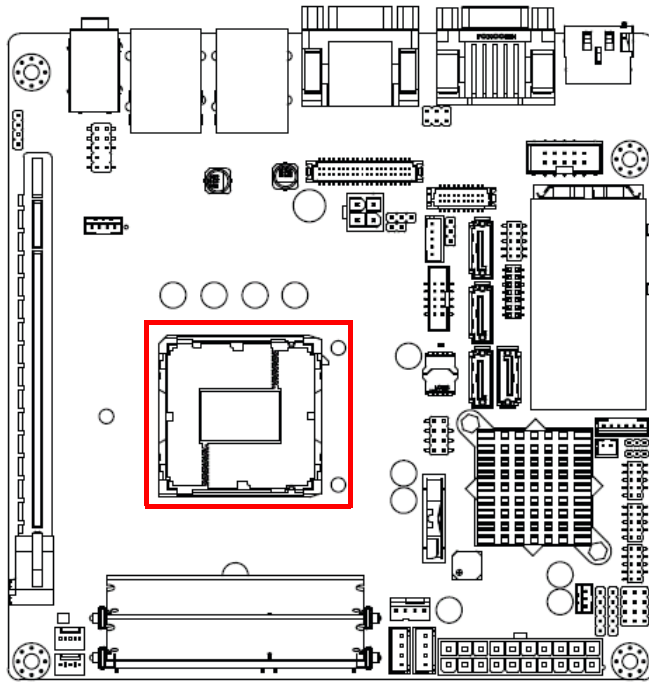

2.30 DDR3 SO-DIMM Socket (DIMMA1, DIMMB1)

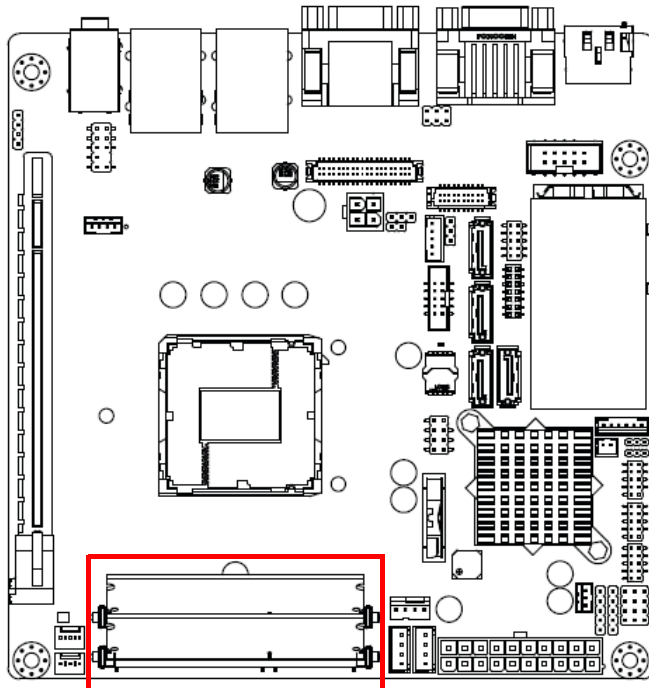

Chapter 3

BIOS Operation

3.1 Introduction

AMI BIOS has been integrated into many motherboards, and has been very popular for over a decade. People sometimes refer to the AMI BIOS setup menu as BIOS, BIOS setup or CMOS setup.

With the AMI BIOS Setup program, you can modify BIOS settings and control the special features of your computer. The Setup program uses a number of menus for making changes and turning special features on or off. This chapter describes the basic navigation of the AIMB-274 setup screens.

3.2 BIOS Setup

The AIMB-274 Series system has AMI BIOS built in, with a CMOS SETUP utility that allows users to configure required settings or to activate certain system features.

The CMOS SETUP saves the configuration in the CMOS RAM of the motherboard. When the power is turned off, the battery on the board supplies the necessary power to preserve the CMOS RAM.

When the power is turned on, press the button during the BIOS POST (Power-On Self Test) to access the CMOS SETUP screen.

Control Keys

< ↑ >> ↓ >> ← >> → >	Move to select item
----------------------	---------------------

<Enter>	Select Item
---------	-------------

<Esc>	Main Menu - Quit and not save changes into CMOS Sub Menu - Exit current page and return to Main Menu
-------	---

<Page Up/+>	Increase the numeric value or make changes
-------------	--

<Page Down/->	Decrease the numeric value or make changes
---------------	--

<F1>	General help, for Setup Sub Menu
------	----------------------------------

<F2>	Item Help
------	-----------

<F5>	Load Previous Values
------	----------------------

<F7>	Load Setup Defaults
------	---------------------

<F10>	Save all CMOS changes
-------	-----------------------

3.2.1 Main Menu

Press to enter AMI BIOS CMOS Setup Utility, the Main Menu will appear on the screen. Use arrow keys to select among the items and press <Enter> to accept or enter the sub-menu.

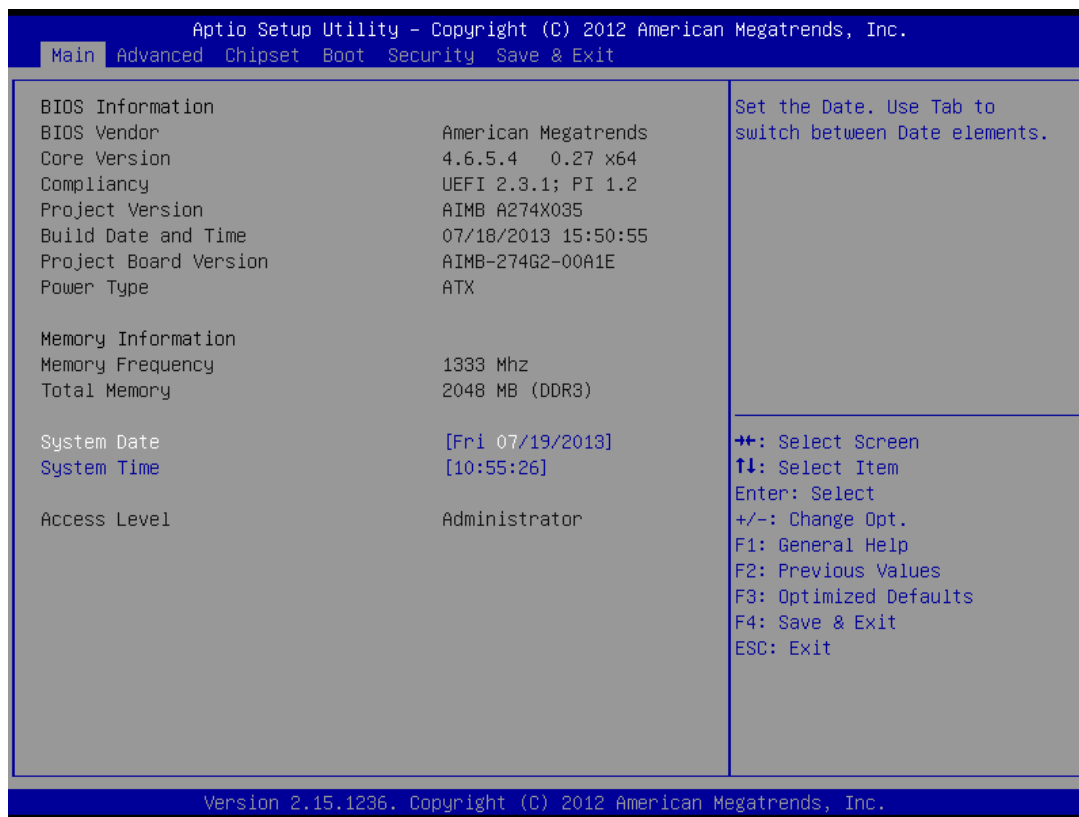

The Main BIOS setup screen has two main frames. The left frame displays all the options that can be configured. Grayed-out options cannot be configured; options in blue can. The right frame displays the key legend.

Above the key legend is an area reserved for a text message. When an option is selected in the left frame, it is highlighted in white. Often a text message will accompany it.

3.2.1.1 System time / System date

Use this option to change the system time and date. Highlight System Time or System Date using the <Arrow> keys. Enter new values through the keyboard. Press the <Tab> key or the <Arrow> keys to move between fields. The date must be entered in MM/DD/YY format. The time must be entered in HH:MM:SS format.

3.2.2 Advanced BIOS Features

Select the Advanced tab from the AIMB-274 setup screen to enter the Advanced BIOS Setup screen. You can select any of the items in the left frame of the screen, such as CPU Configuration, to go to the sub menu for that item. You can display an Advanced BIOS Setup option by highlighting it using the <Arrow> keys. All Advanced BIOS Setup options are described in this section. The Advanced BIOS Setup screen is shown below. The sub menus are described on the following pages.

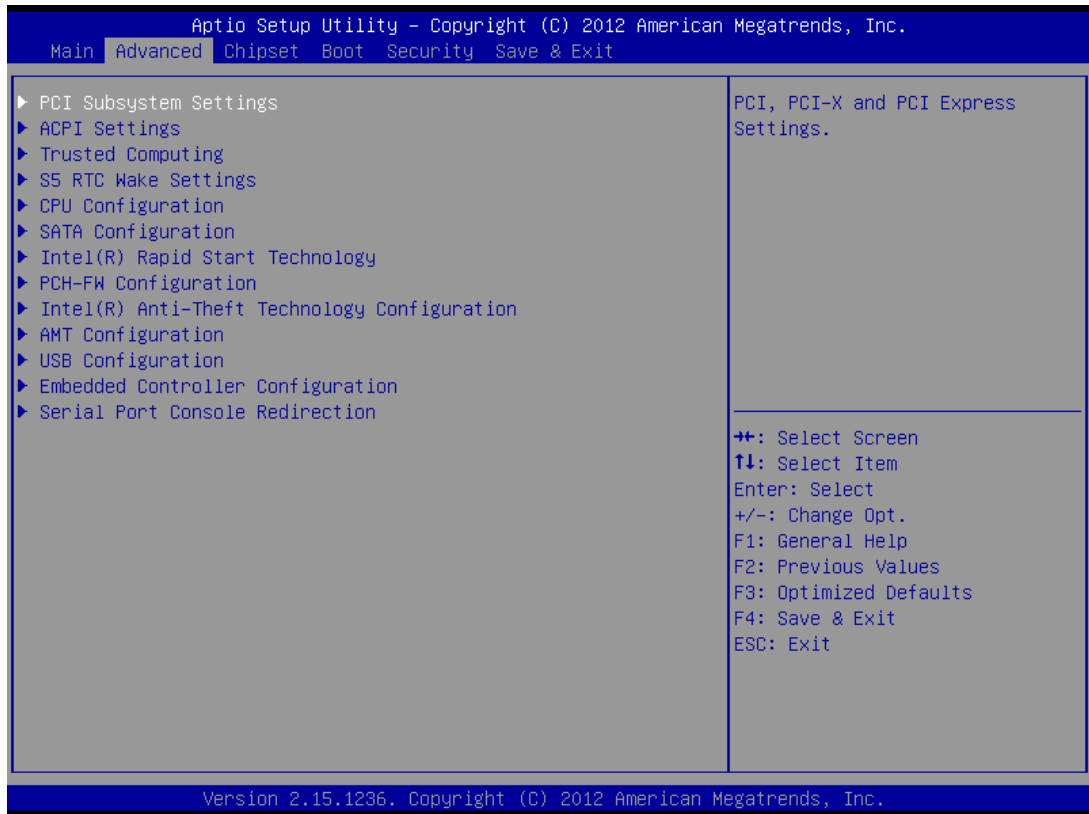

3.2.2.1 PCI Subsystem Settings

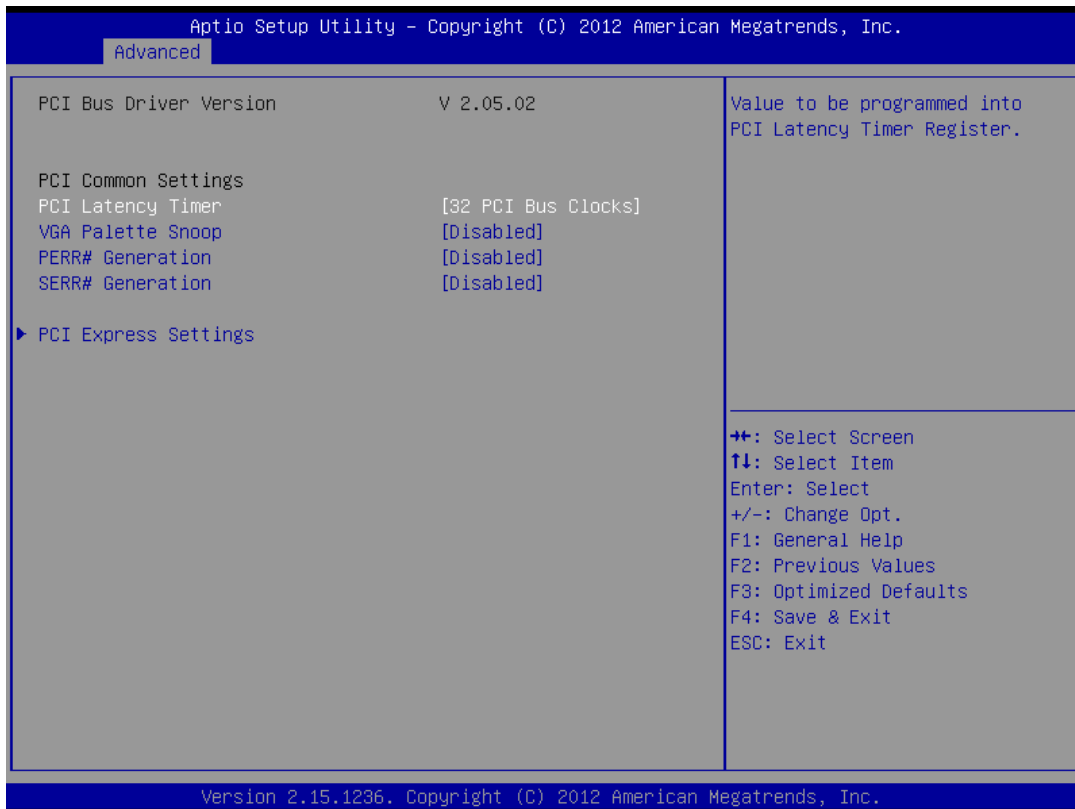

PCI Common Settings

- **PCI Latency Timer**
Value to be programmed into PCI Latency Timer Register.
- **VGA Palette Snoop**
Enable or Disable VGA palette registers snooping.
- **PERR# Generation**
Enable or Disable PERR# Generation.
- **SERR#Generation**
Enable or Disable SERR# Generation.

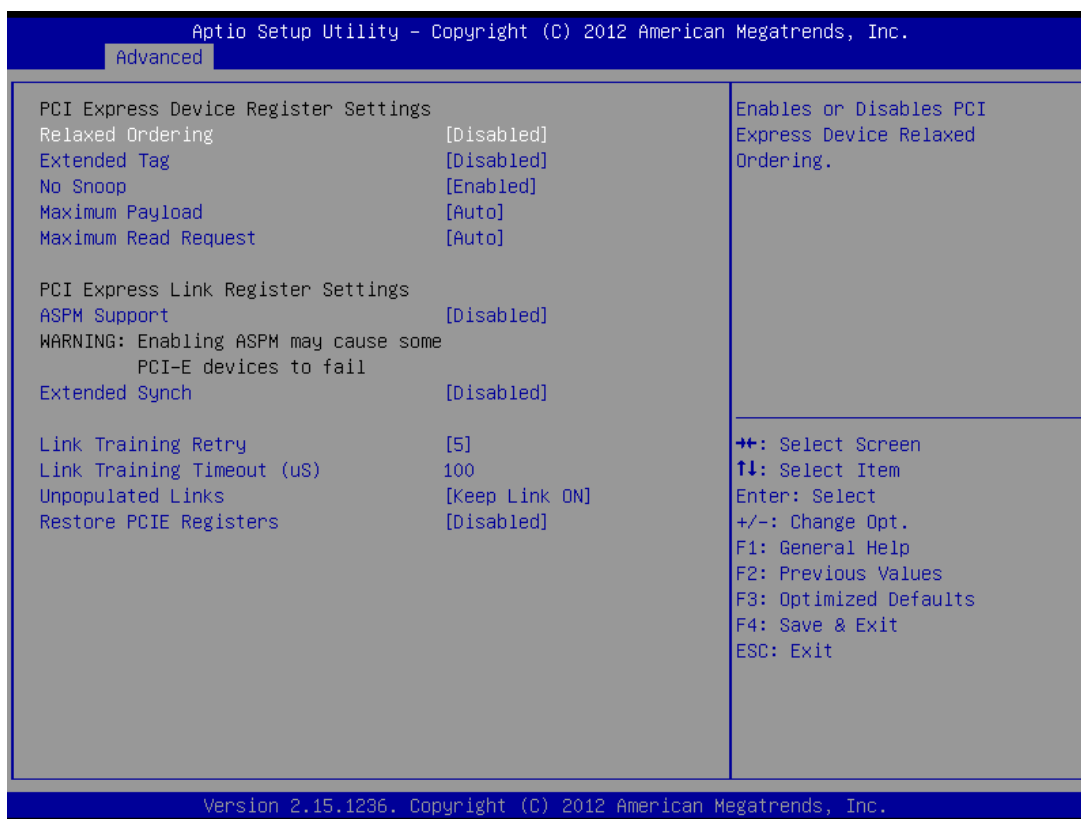

PCI Express Device Register Settings

- **Relaxed Ordering**
Enable or disable Relaxed Ordering.
- **Extended Tag**
Enable or disable Extended Tag.
- **No Snoop**
Enable or disable No Snoop.
- **Maximum Payload**
Set Maximum Payload of PCI Express Device or allow System BIOS to select the value.
- **Maximum Read Request**
Set Maximum Read Request Size of PCI Express Device or allow System BIOS to select the value.

PCI Express Link Register Settings

- **ASPM Support**
Enable or disable ASPM Support
- **Extended Synch**
Enable or disable Extended Synch
- **Link Training Retry**
Defines number of retry attempts software will take to retrain the link if previous training attempt was unsuccessful.
- **Link Training Timeout**
Defines number of micro-seconds software that will wait before polling "Link Training " bit in link status register. Values range from 10 to 1000 uS.
- **Unpopulated Links**

In order to save power, software will disable unpopulated PCI Express links, if this option set to 'Disable Link'.

- **Restore PCIE Registers**

On non-PCI Express aware OS's (Pre Windows Vista) some devices may not be correctly reinitialized after S3. Enabling this register PCI Express device configurations on S3 resume. Warning: Enabling this may cause issues with other hardware after S3 resume.

3.2.2.2 ACPI Settings

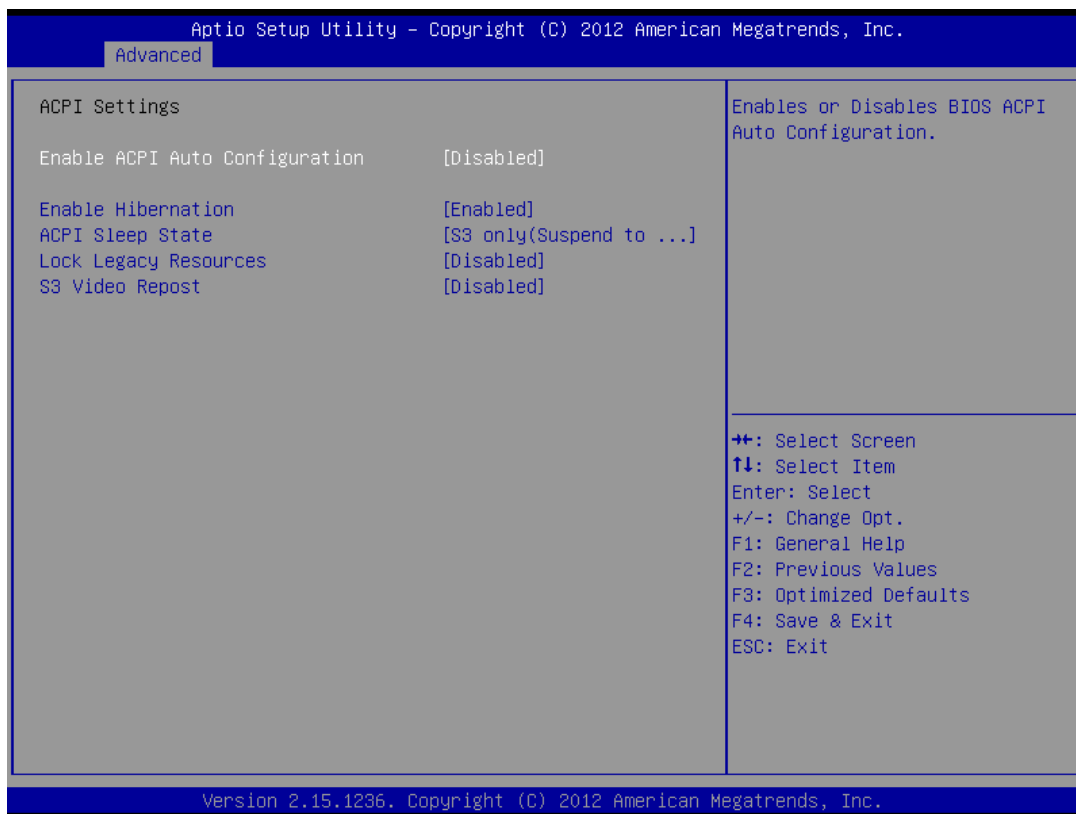

- **Enable ACPI Auto Configuration**
Enable or disable BIOS ACPI Auto Configuration
- **Enable Hibernation**
This item allows users to enable or disable hibernation
- **ACPI Sleep state**
This item allows users to set the ACPI sleep state
- **Lock Legacy Resources**
This item allows users to lock legacy devices' resources.
- **S3 Video Repost**
Enable or disable video repost

3.2.2.3 Trusted Computing

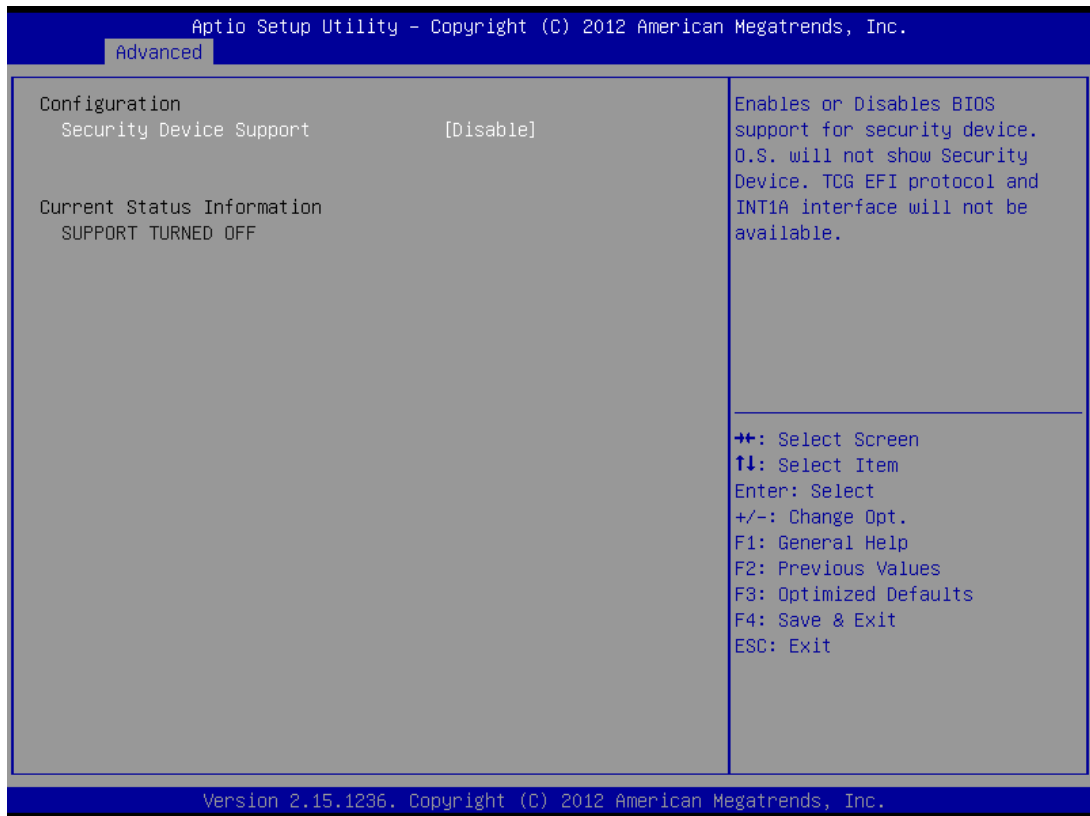

- **Security Device Support**
Enable or disable BIOS support for security device.

3.2.2.4 S5 RTC wake Settings



- **Wake system with fixed time**
Enable or disable system wake on alarm event

3.2.2.5 CPU Configuration

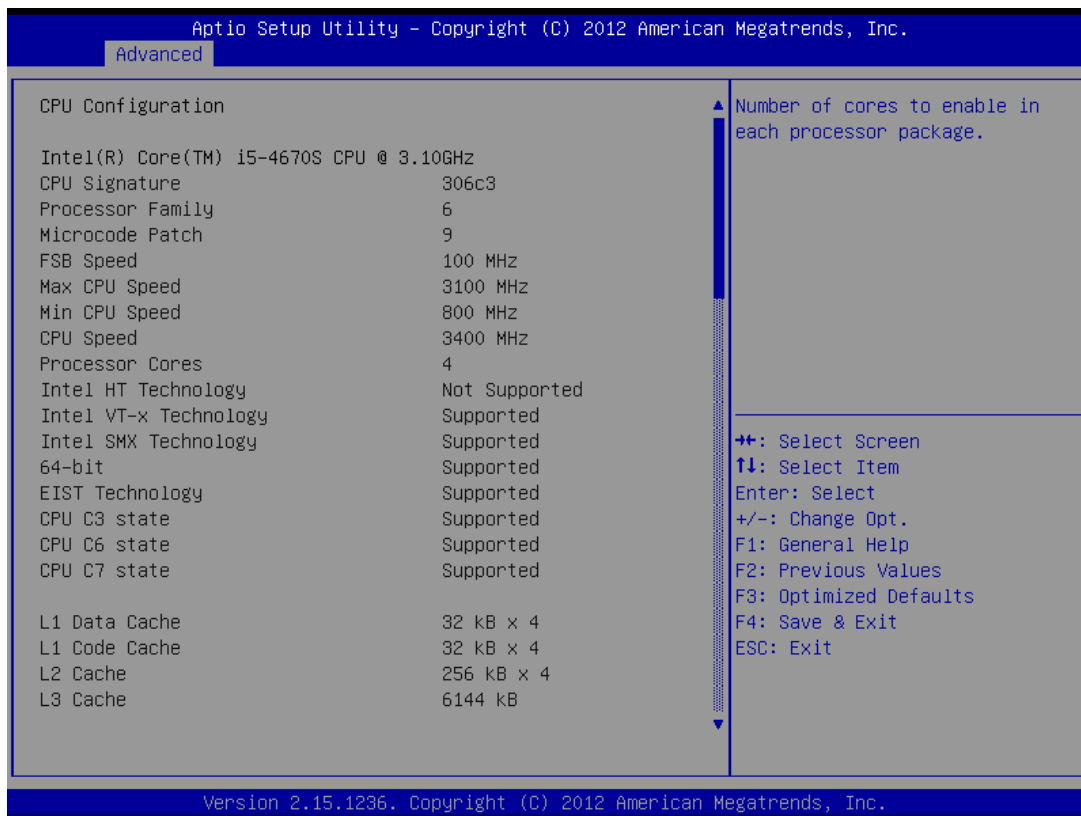

3.2.2.6 SATA Configuration

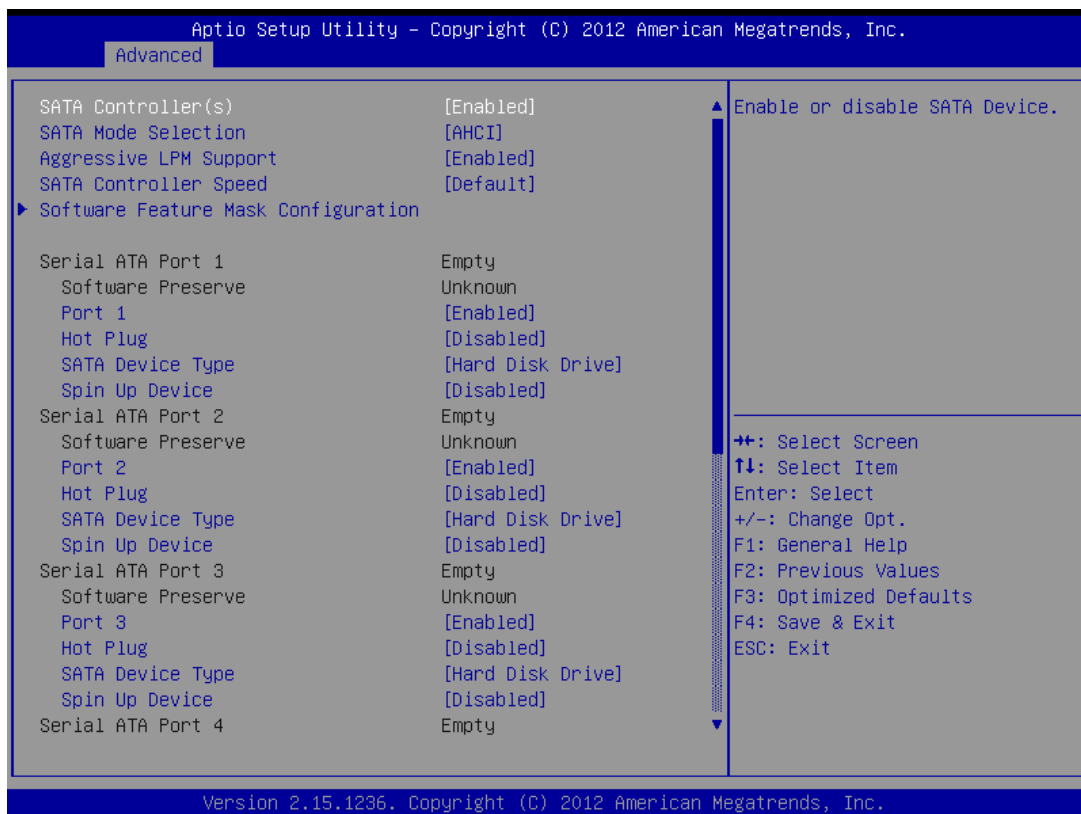

SATA Controller(s)

This item allows users to enable or disable the SATA device.

SATA Mode Selection

This item allows users to select mode of SATA controller(s).

Aggressive LPM Support

This item allows users to enable or disable Aggressive LPM Support.

SATA Controller Speed

Indicates the maximum speed the SATA controller can support.

Software Feature Mask Configuration

RAID OROM/RST driver will refer to the SWFM configuration to enable or disable the storage features.

Serial ATA Port 1

- **Port 1**
Enable or disable SATA Port 1.
- **Hot Plug**
Enable or disable hot plug function.
- **SATA Device Type**
Select the type for SATA device.
- **Spin Up Device**
Enable or disable Spin up device.

Serial ATA Port 2

- **Port 2**
Enable or disable SATA Port 2.
- **Hot Plug**
Enable or disable hot plug function.
- **SATA Device Type**
Select the type for SATA device.
- **Spin Up Device**
Enable or disable Spin up device.

Serial ATA Port 3

- **Port 3**
Enable or disable SATA Port 3
- **Hot Plug**
Enable or disable hot plug function.
- **SATA Device Type**
Select the type for SATA device.
- **Spin Up Device**
Enable or disable Spin up device.

Serial ATA Port 4

- **Port 4**
Enable or disable SATA Port 4.
- **Hot Plug**
Enable or disable hot plug function.
- **SATA Device Type**
Select the type for SATA device.
- **Spin Up Device**
Enable or disable Spin up device.

3.2.2.7 RAID Configuration

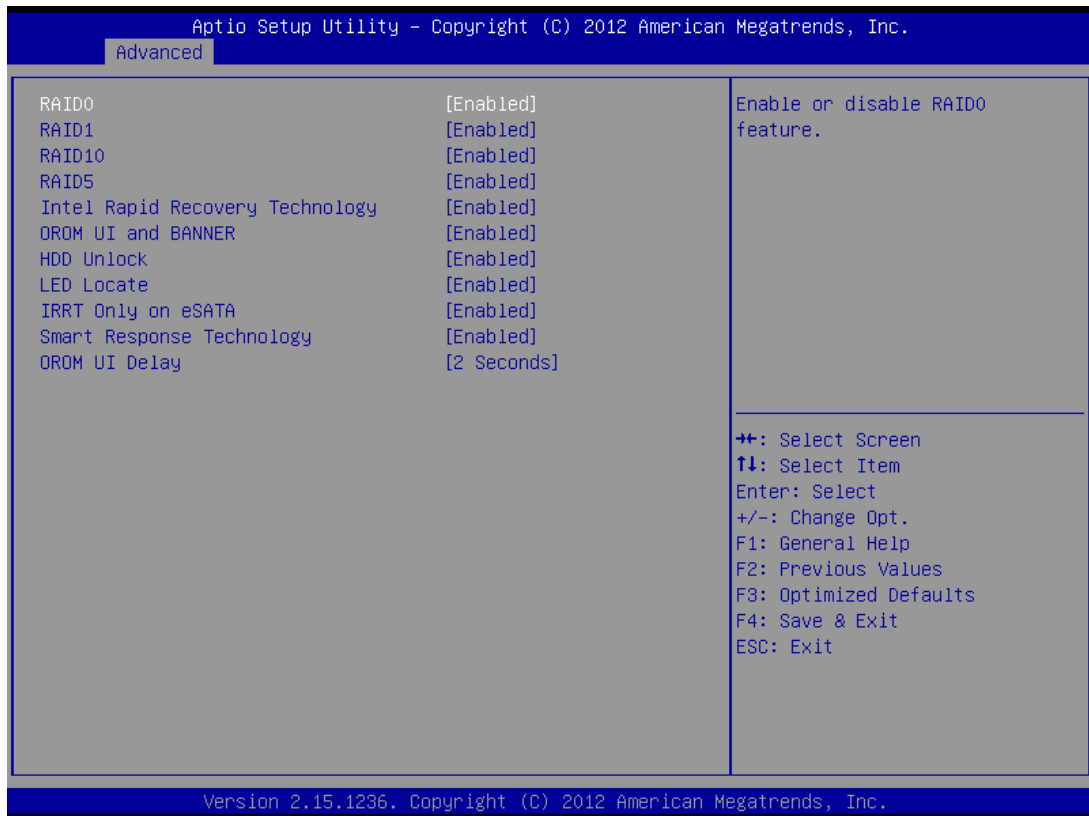

- **RAID0**
Enable or disable RAID 0.
- **RAID1**
Enable or disable RAID 1.
- **RAID10**
Enable or disable RAID 10.
- **RAID5**
Enable or disable RAID 5.
- **Intel Rapid Recovery Technology**
Enable or disable Intel Rapid Recovery Technology.
- **OROM UI and BANNER**
Enable or disable OROM UI and BANNER.
- **HDD Unlock**
Enable or disable HDD Unlock.
- **LED Locate**
Enable or disable LED Locate.
- **IRRT Only on eSATA**
Enable or disable IRRT Only on eSATA.
- **Smart Response Technology**
Enable or disable Smart Response Technology.
- **OROM UI delay**
This item allows users to choose the delay time for option ROM.

3.2.2.8 INTEL Rapid Star Technology

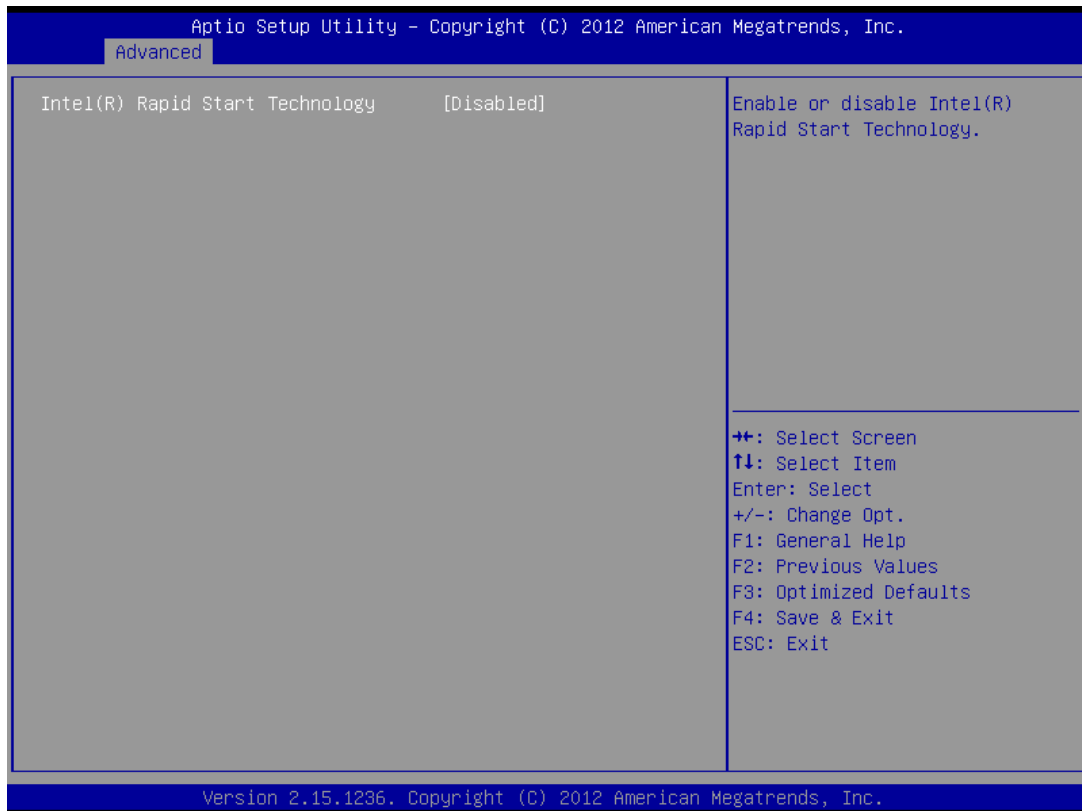

- **Intel® Rapid start technology**
This item allows users to enable or disable Intel rapid start technology.

3.2.2.9 PCH(FW) Configuration

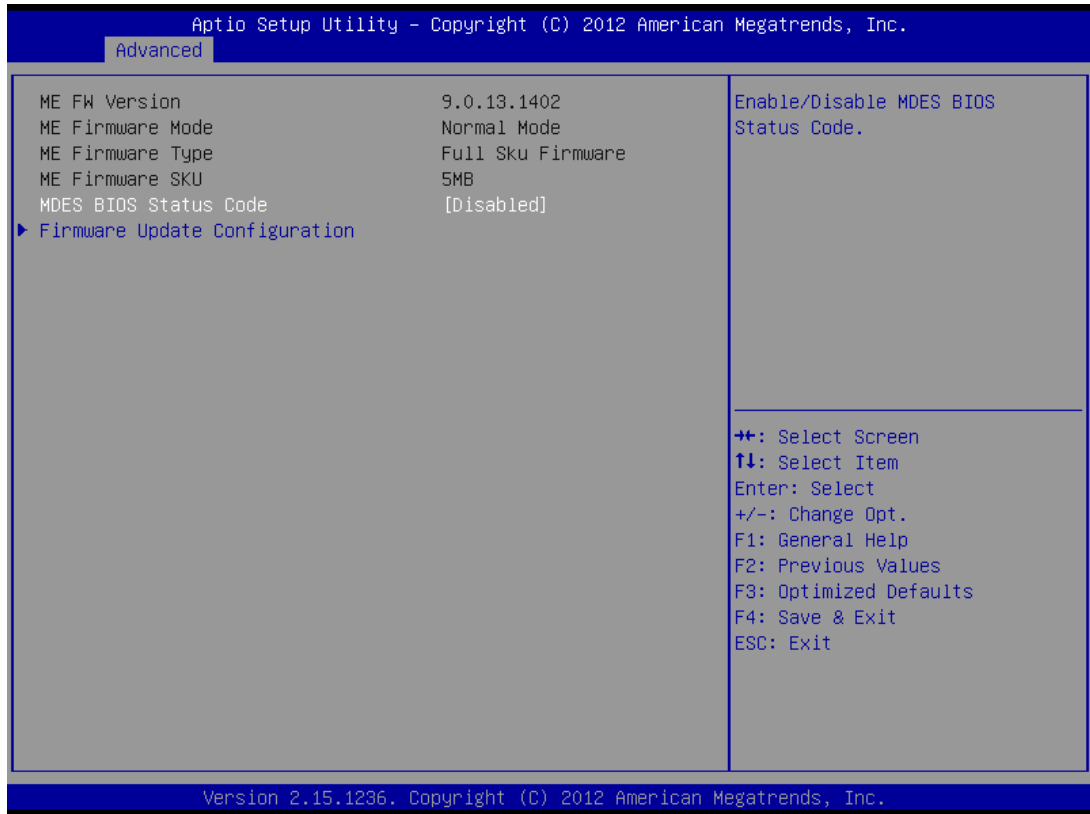

- **PCH-FW Version**
PCH-FW page shows Intel ME FW information.
- **MDES BIOS Status Code**
Enable or disable MDES BIOS Status Code.



■ Me FW Image Re-Flash

This item allows users to enable or disable Me FW image re-flash function.

3.2.2.10 Intel® Anti-Theft Technology Configuration

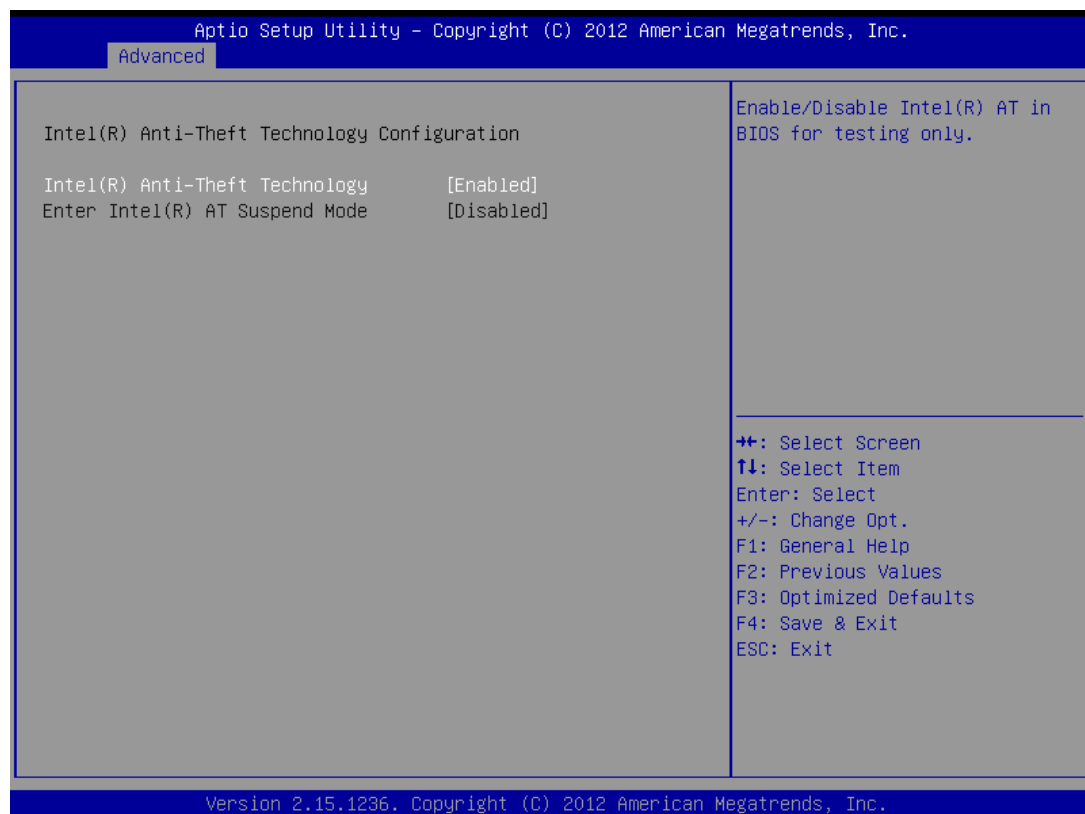

- **Intel® Anti-theft Technology**
This item allows users to enable or disable Intel AT in BIOS for testing only.
- **Enter Intel® AT Suspend Mode**
This item allows users to enable or disable enter Intel AT suspend mode function.

3.2.2.11 Intel AMT Configuration

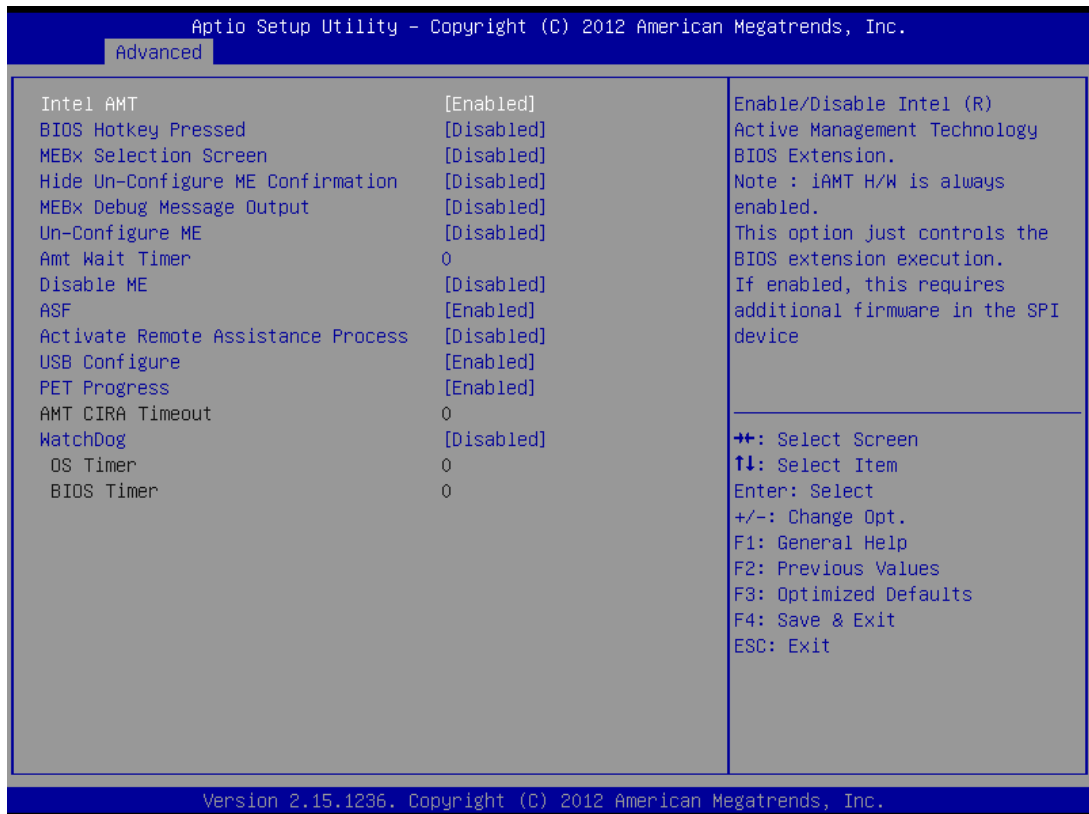

- **Intel AMT**
This item allows users to enable or disable Intel AMT BIOS extension.
- **BIOS Hotkey Pressed**
This item allows users to enable or disable BIOS hotkey press.
- **MEBx Selection Screen**
This item allows users to enable or disable MEBx selection screen.
- **Hide Un-Configuration ME Confirmation**
This item allows users to hide un-configure ME without password confirmation prompt.
- **MEBx Debug Message Output**
This item allows users to enable or disable MEBx debug message.
- **Un-Configure ME**
This item allows users to un-configure ME without password.
- **Amt Wait Timer**
Set timer to wait before sending ASF_GET_BOOT_OPTIONS.
- **Disable ME**
This item allows users to enable or disable ME function.

- **ASF**
This item allows users to enable or disable Alert Specification Format.
- **Activate Remote Assistance Process**
This item allows users to enable or disable trigger CIRA boot.
- **USB Configure**
This item allows users to enable or disable USB configure function.
- **PET Progress**
This item allows users to enable or disable PET events progress to receive PET events or not.
- **AMT CIRA Timeout**
OEM defined timeout for MPS connection to be established.
- **WatchDog**
This item allows users to enable or disable WatchDog Timer.
- **OS Timer**
Sets OS watchdog timer.
- **BIOS Timer**
Sets BIOS watchdog timer.

3.2.2.12 USB configuration

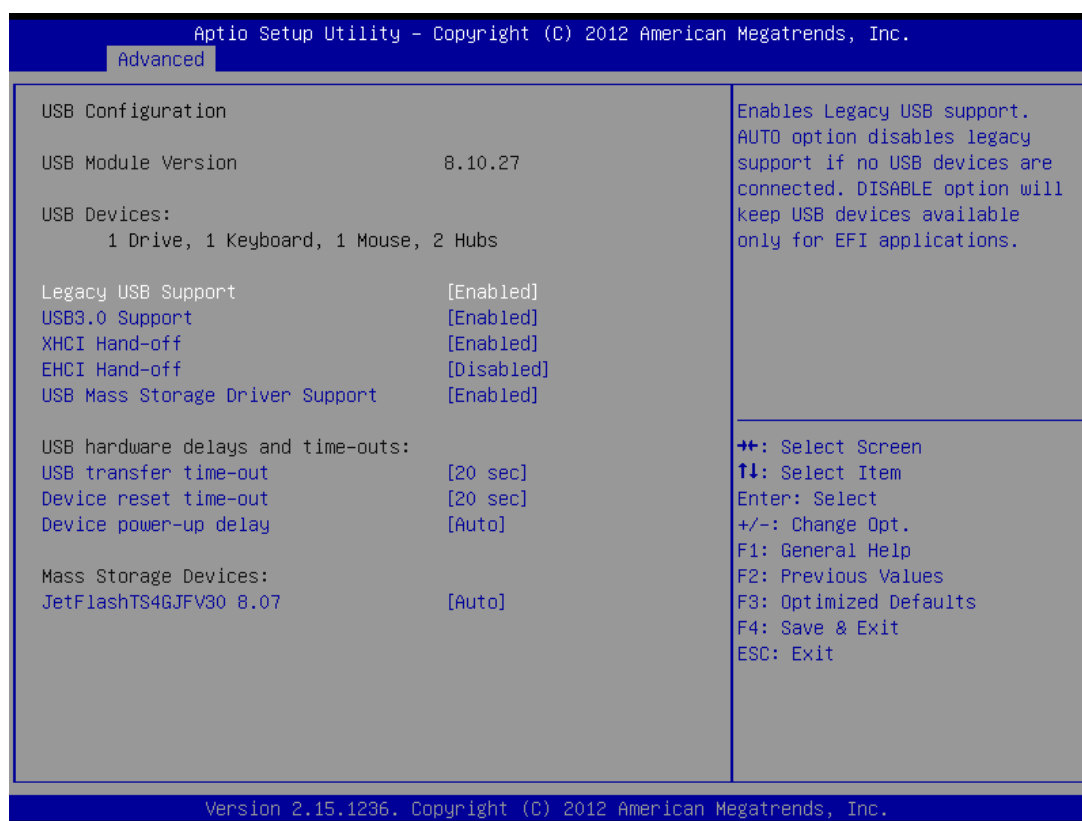

- **Legacy USB support**
Enables support for legacy USB. Auto option disables legacy support if no USB devices are connected.
- **USB3.0 support**
This item allows users to enable or disable USB3.0 function.
- **XHCI Hand-off**

This is a workaround for OS without XHCI hand-off support. The XHCI ownership change should claim by XHCI driver.

- **EHCI Hand-off**

This is a workaround for OS without EHCI hand-off support. The EHCI ownership change should claim by EHCI driver.

- **USB Mass Storage Driver Support**

This item allows users to enable or disable USB Mass Storage Driver.

- **USB transfer time-out**

Time-out value for control, bulk, and interrupt transfers.

- **Device reset time-out**

USB mass storage device starts unit command time-out.

- **Device power-up delay**

Maximum time the device will take before it properly report itself to the host controller.

- **Mass storage device**

Mass storage device emulation type. 'AUTO' enumerates devices according to their media format. Optical drives are emulated as 'CDROM', drives with no media will be emulated according to a drive type.

3.2.2.13 Embedded Controller configuration

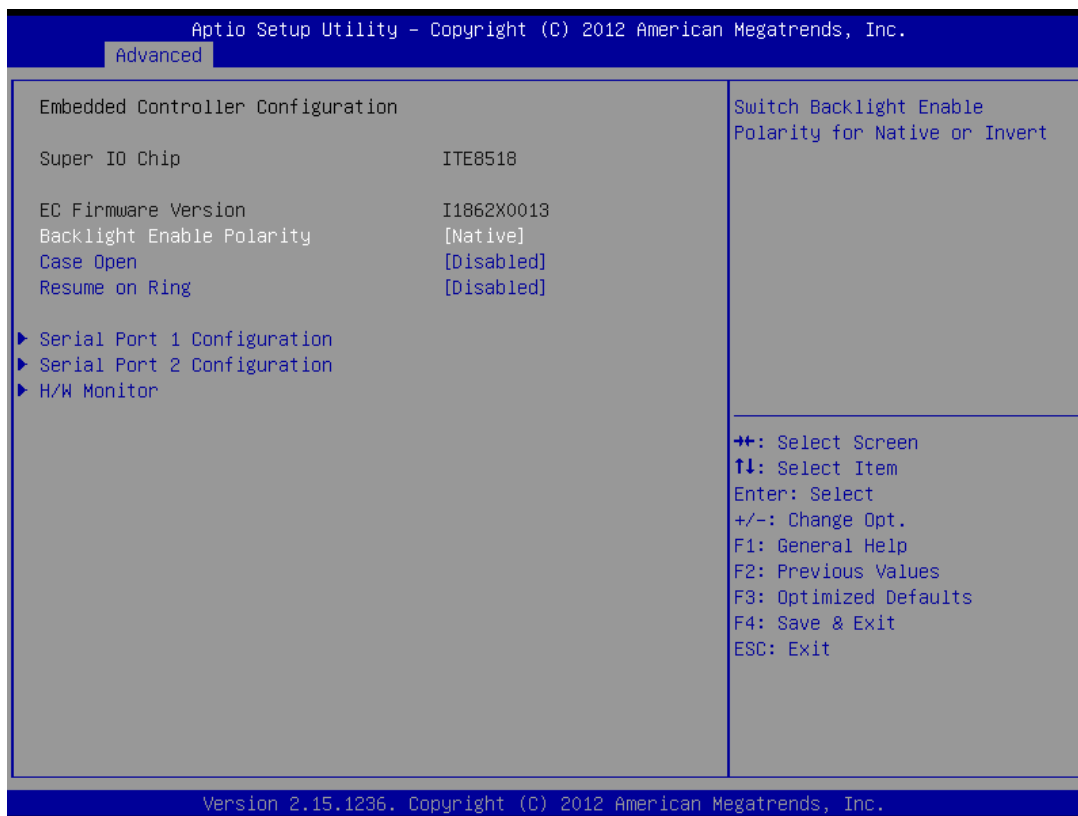

- **Backlight Enable Polarity**

This item allows users to set backlight enable polarity.

- **Case open**

This item allows users to enable or disable case open function.

- **Resume on Ring**

This item allows users to enable or disable resume on ring function.

3.2.2.14 Super IO Configuration

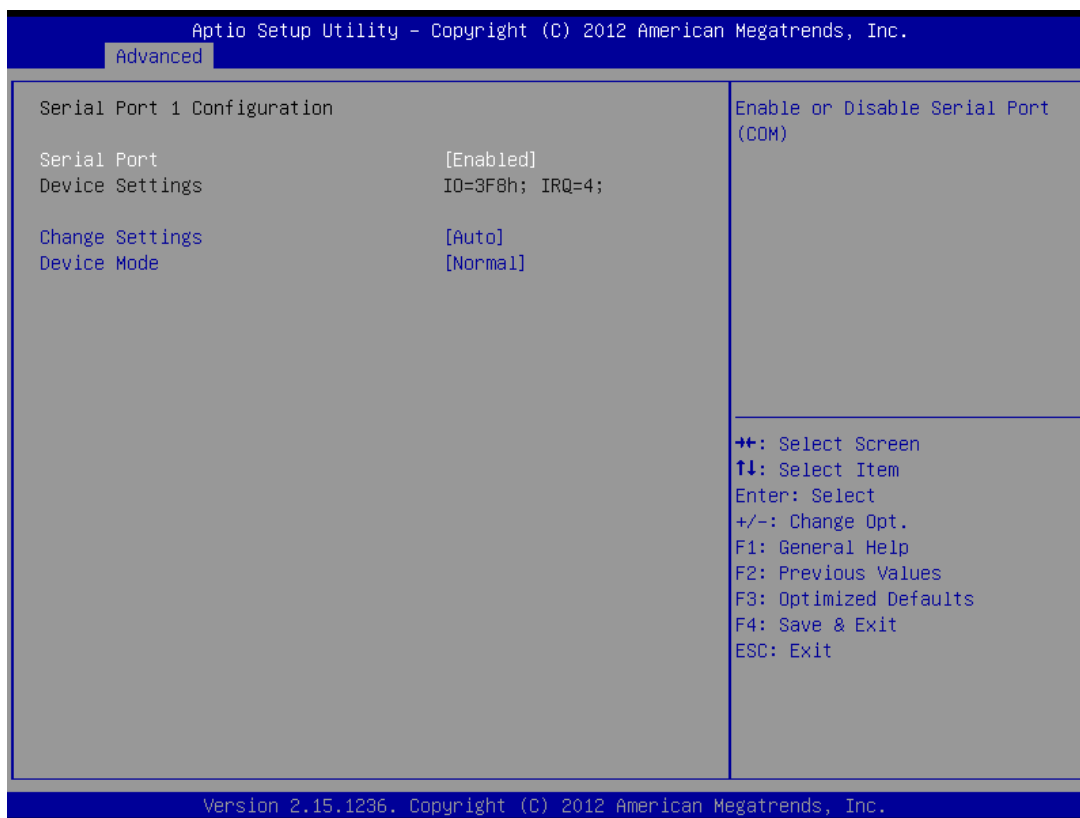

- **Serial Port**
This item will allow users to enable or disable serial port.
- **Change Settings**
This item allows users to change the serial port setting.
- **Device Mode**
This item allows users to change the device mode.
- **Interface Config**
Change the Serial interface. Select <RS-232> ,<RS-422> or <RS-485> interface.
- **RS422/RS485 Termination resistors**
If serial interface is RS422 or RS485, please enable this item.

3.2.2.15 PC Health Status

This Page Shows AIMB-274 PC Health.

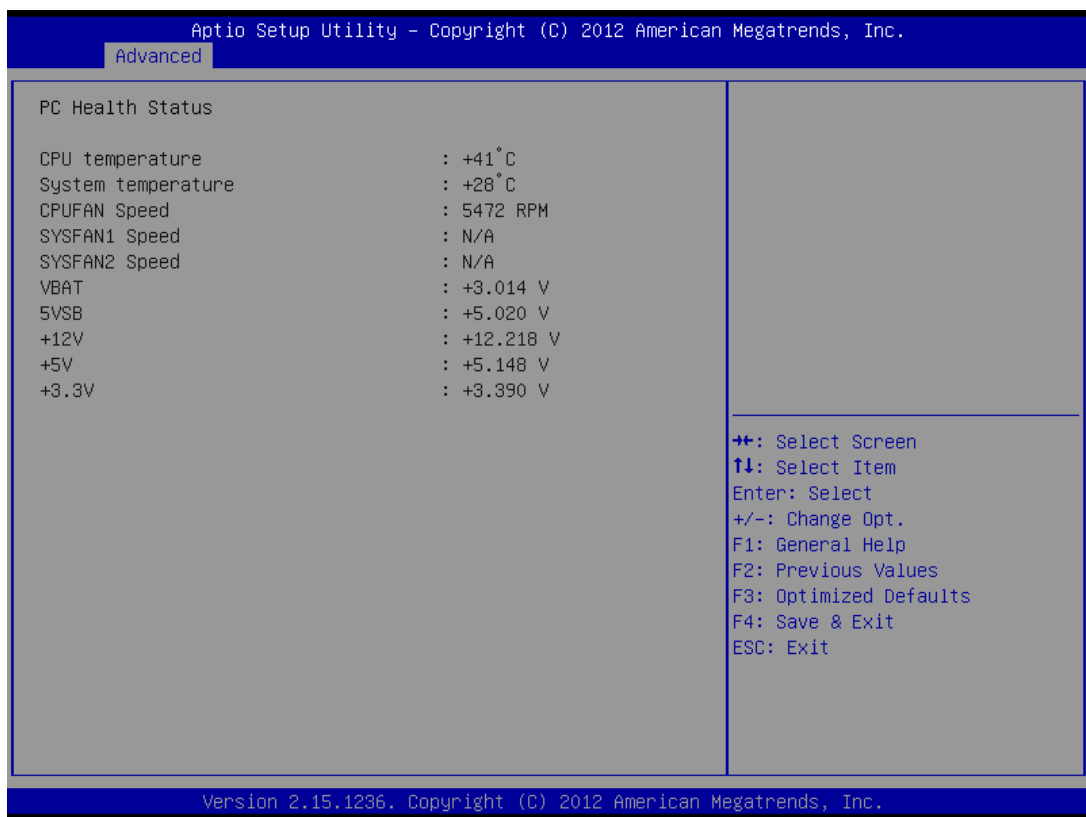

3.2.2.16 Serial Port Console Redirection

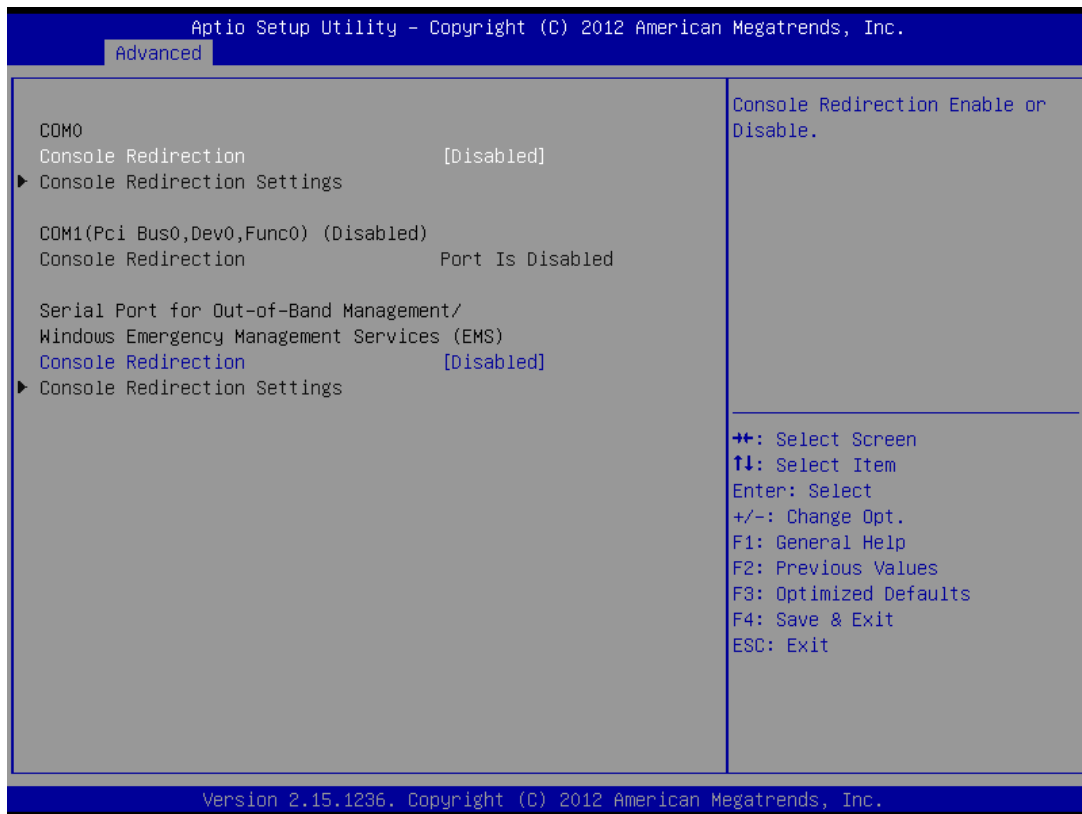

- **Console Redirection**

This item allows users to enable or disable console redirection.

3.2.3 Chipset

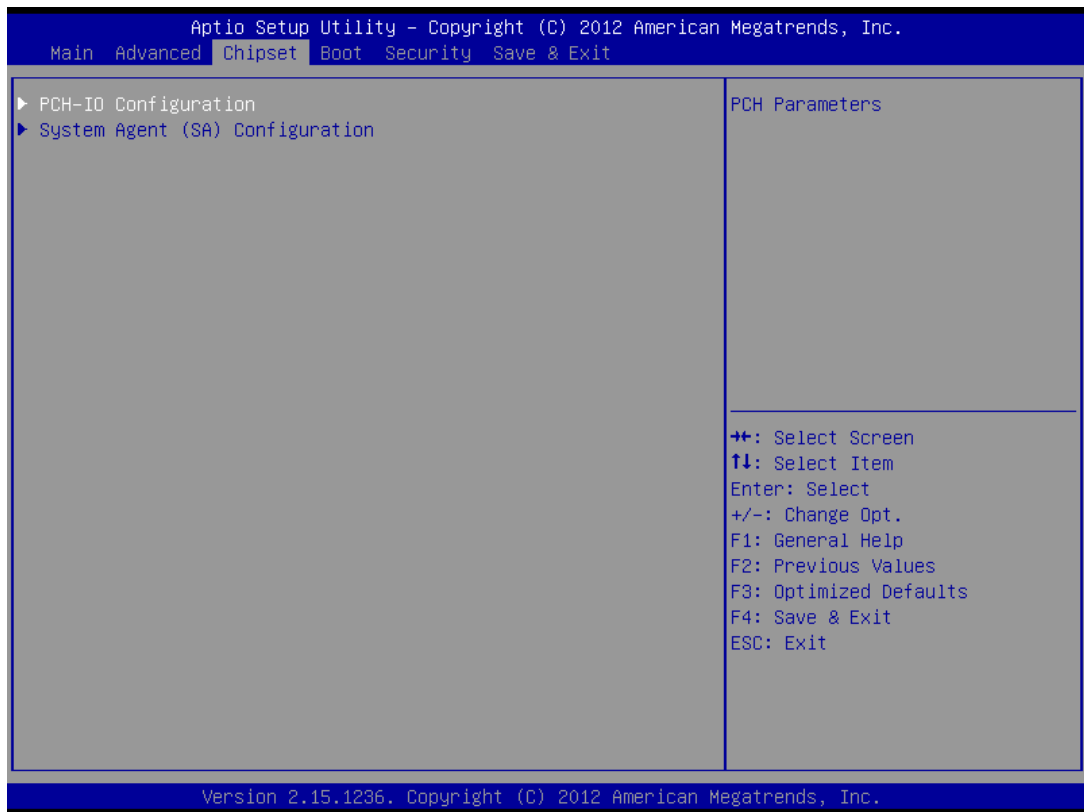

This page provides information of the chipset on AIMB-274.

PCH-IO Configuration



PCI Express Configuration

Details of PCI Express items.

USB Configuration

Details of USB items.

PCH Azalia Configuration

Details of PCH azalia items.

LAN 1 controller

Enable or disable the LAN 1 controller.

- **LAN 1 PXE OpROM**

Enable or disable the LAN 1 option-ROM.

- **Wake on LAN**

Enable or disable integrated LAN to wake the system. (The Wake On LAN cannot be disabled if ME is on at Sx state)

LAN 2 controller

Enable or disable the LAN 2 controller.

- **LAN 2 PXE OpROM**

Enable or disable the LAN 2 option-ROM.

PCIE Wake

Enable or disable PCIE to wake the system from S5.

DeepSx Power Policies

Enable or Disable Deep Sleep mode.

Restore AC Power Loss

This item allows users to select off, on and last state.

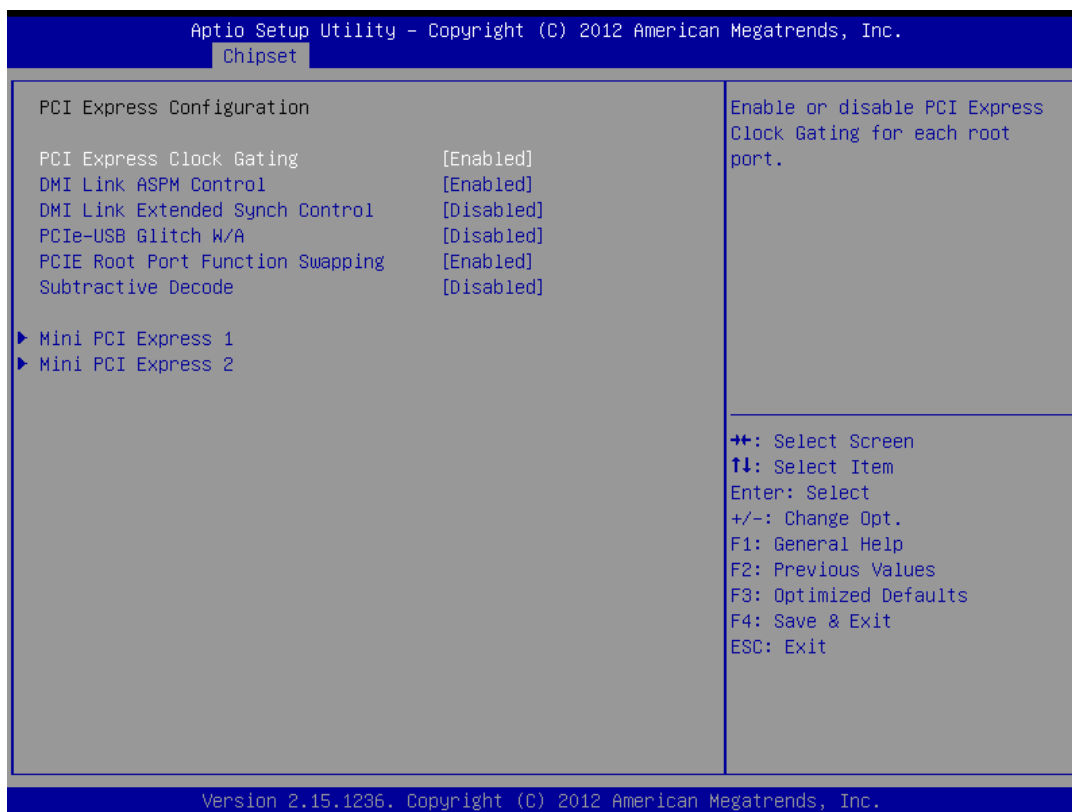
3.2.3.1 PCI Express Configuration

- **PCI Express Clock Gating**
This item allows users to enable or disable the PCI Express Clock Gating.
- **DMI Link ASPM Support**
This item allows users to enable or disable ASPM.
- **DMI Link Extended Synch Control**
This item allows users to enable or disable DMI Link Extended Synch.
- **PCIe-USB Glitch W/A**
This item allows users to enable or disable PCIe-USB Glitch W/A.
- **PCIE Root Port Function Swapping**
This item allows users to enable or disable PCIE Root Port Function Swapping.
- **Subtractive Decode**
This item allows users to enable or disable Subtractive Decode.

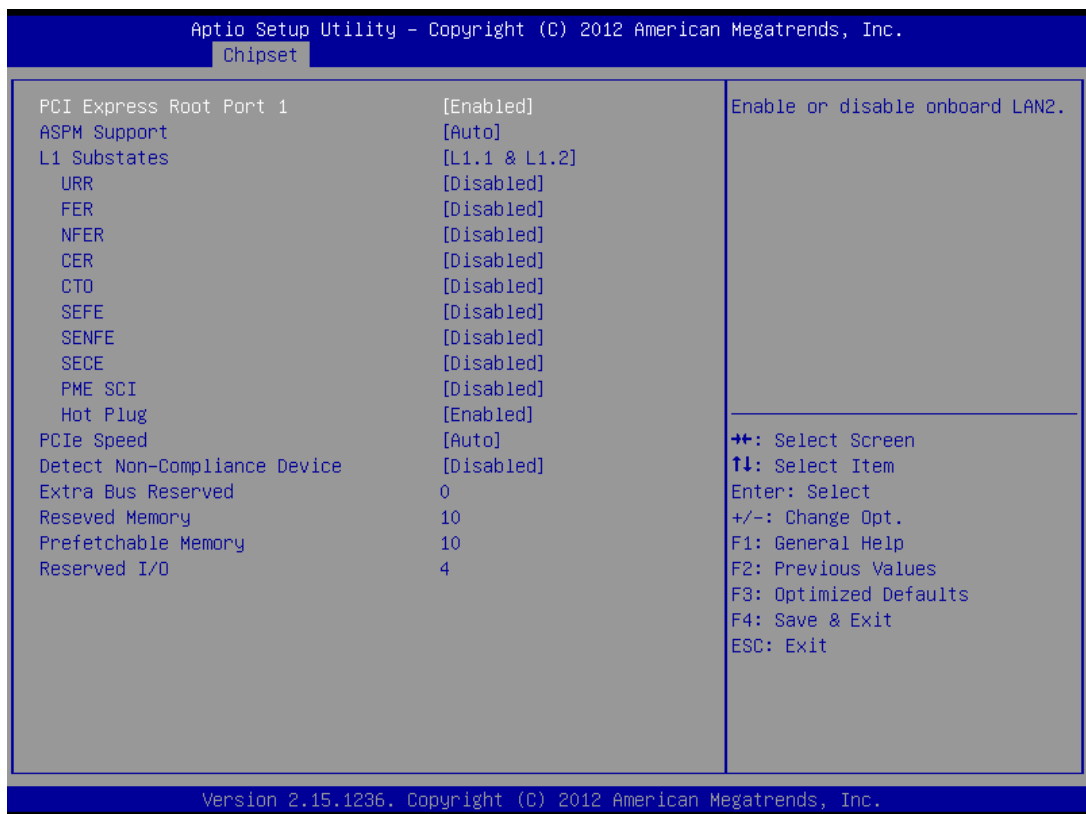

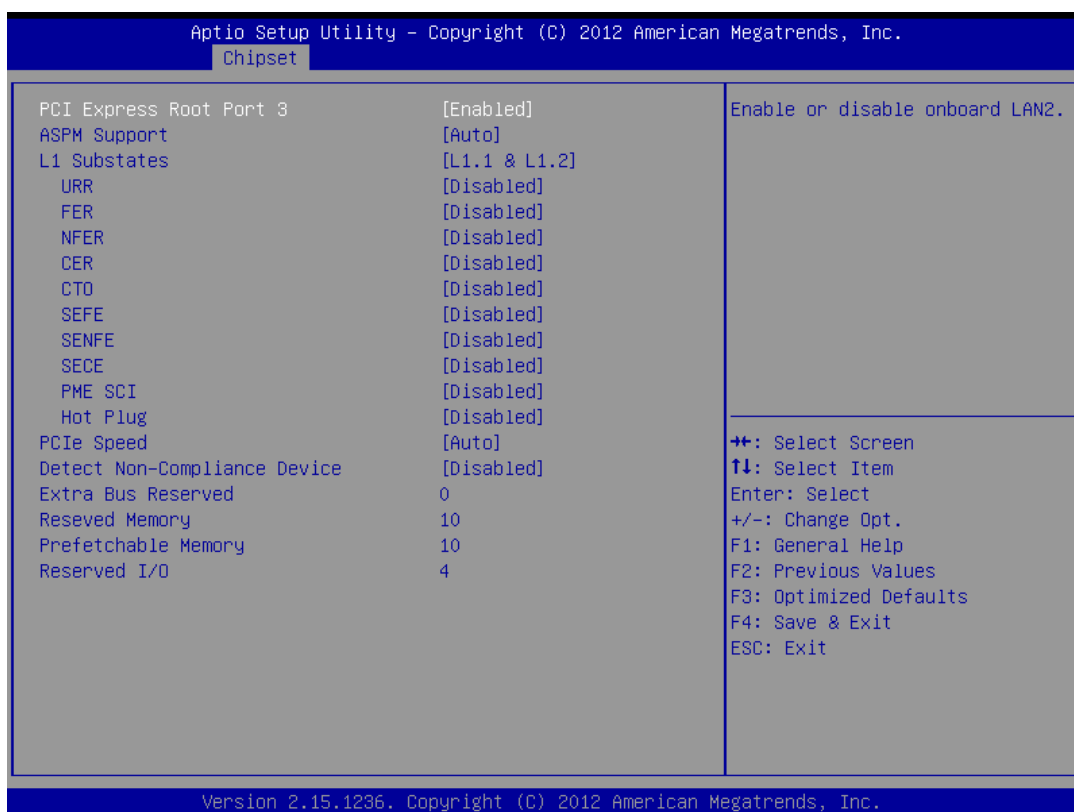

- **PCI Express Root Port 1 & 3**
Control the PCI Express Root Port
- **ASPM Support**
This item allows users to enable or disable PEG ASPM.
- **L1 Substates**
This item allows users to select L1.1 or L1.2.
- **URR**
This item allows users to enable or disable the URR function.
- **FER**
This item allows users to enable or disable the FER function.
- **NFER**
This item allows users to enable or disable the NFER function.
- **CER**
This item allows users to enable or disable the CER function.
- **CTO**
This item allows users to enable or disable the CTO function.
- **SEFE**
This item allows users to enable or disable the SEFE function.
- **SENF**
This item allows users to enable or disable the SENFE function.
- **SECE**
This item allows users to enable or disable the SECE function.
- **PME SCI**
This item allows users to enable or disable the PME SCI function.
- **Hot Plug**
This item allows users to enable or disable the PCI Express hot plug function.
- **PCIe Speed**
Select PCI Express port speed [Auto, Gen1, Gen2].

- **Detect Non-Compliance Device**
Detect Non-Compliance PCI Express Device. If enable, it will take more time at POST time.

3.2.3.2 USB Configuration

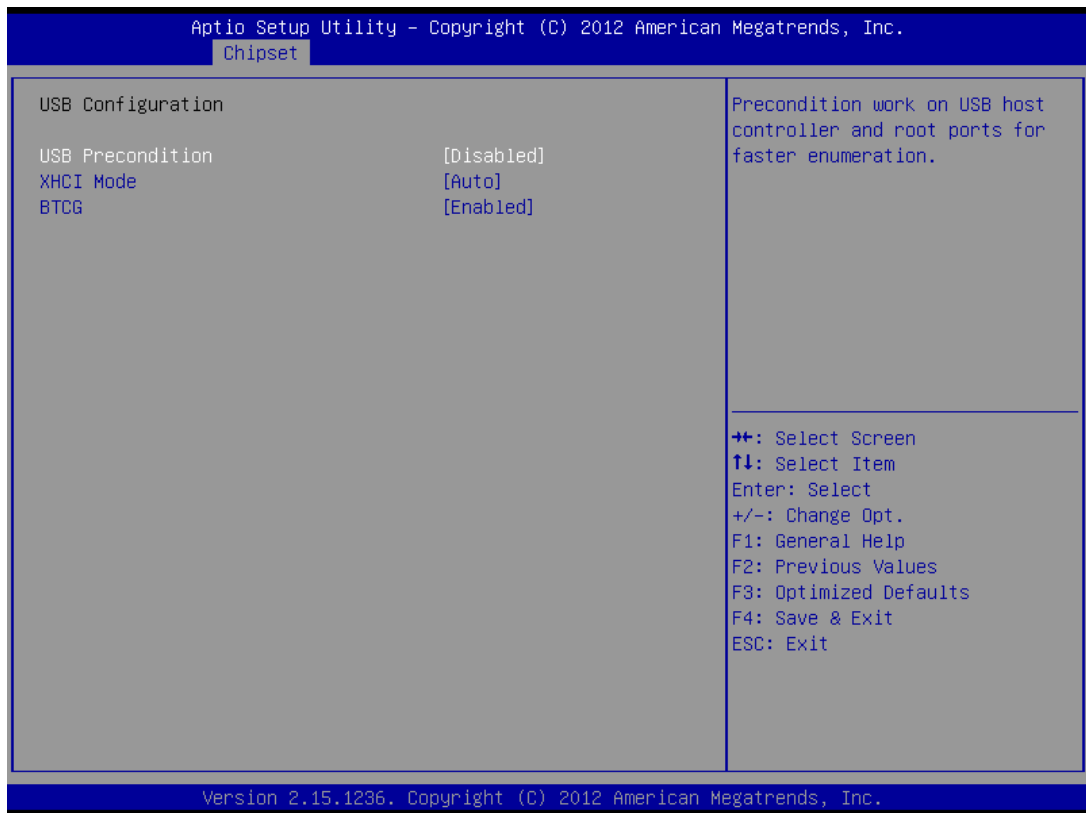

- **USB Precondition**
This item allows user to enable or disable USB Precondition.
- **XHCI Mode**
Select Smart auto, Auto, Enabled and Disable Mode of operation of XHCI controller.

Note! *Smart auto setting remembers the last setting, but auto mode does not.*



Using smart auto setting, USB devices may not be recognized when system rebooting with more than one USB device connected.

- **BTCG**
Enables or disables the BTCG function.

3.2.3.3 PCH Azalia Configuration

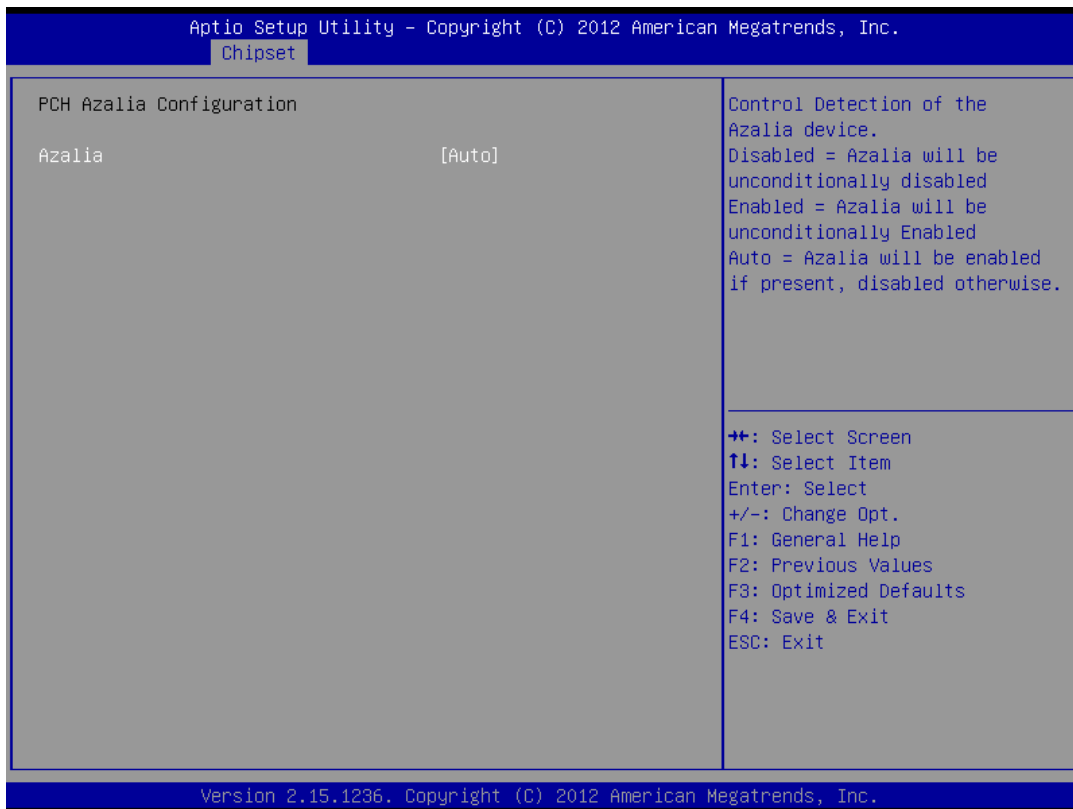

- **Azalia**
 - Control detection of the Azalia device.
 - Disable = Azalia will be unconditionally disabled
 - Enable=Azalia will be unconditionally enabled
 - Auto=Azalia will be enabled if present, disabled otherwise

3.2.3.4 System Agent (SA) Configuration

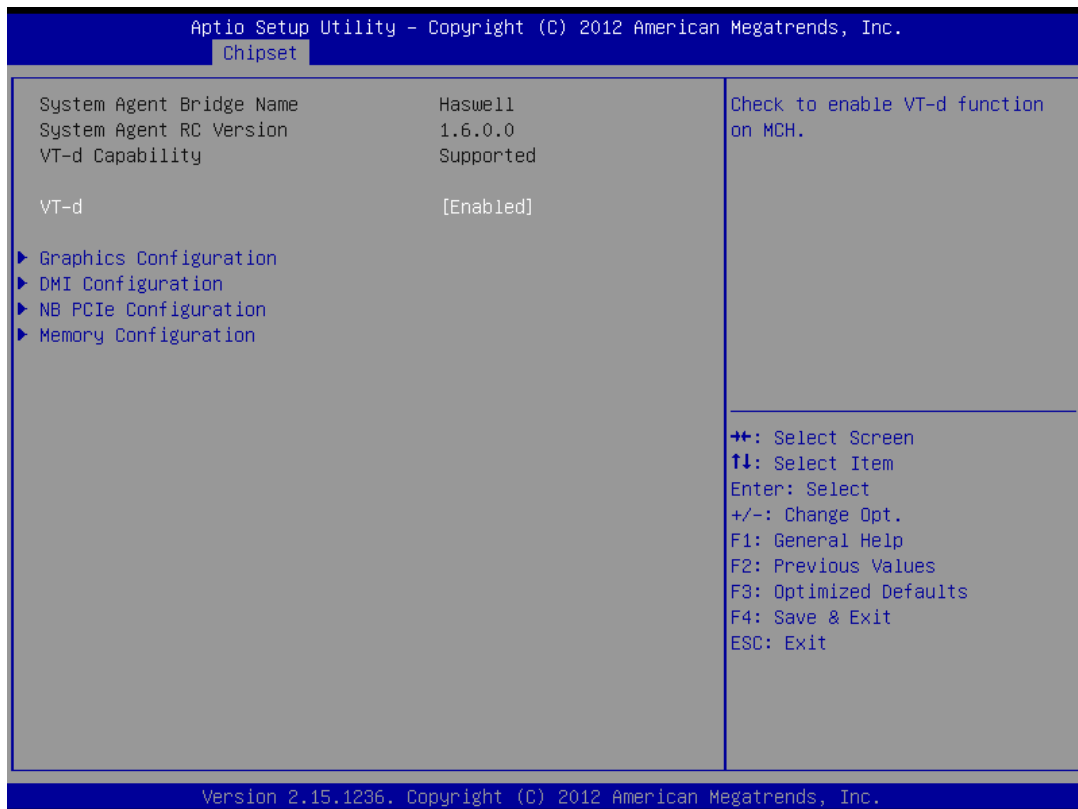

■ VT-d

This item allows users to enable or disable VT-d.

Graphic Configuration

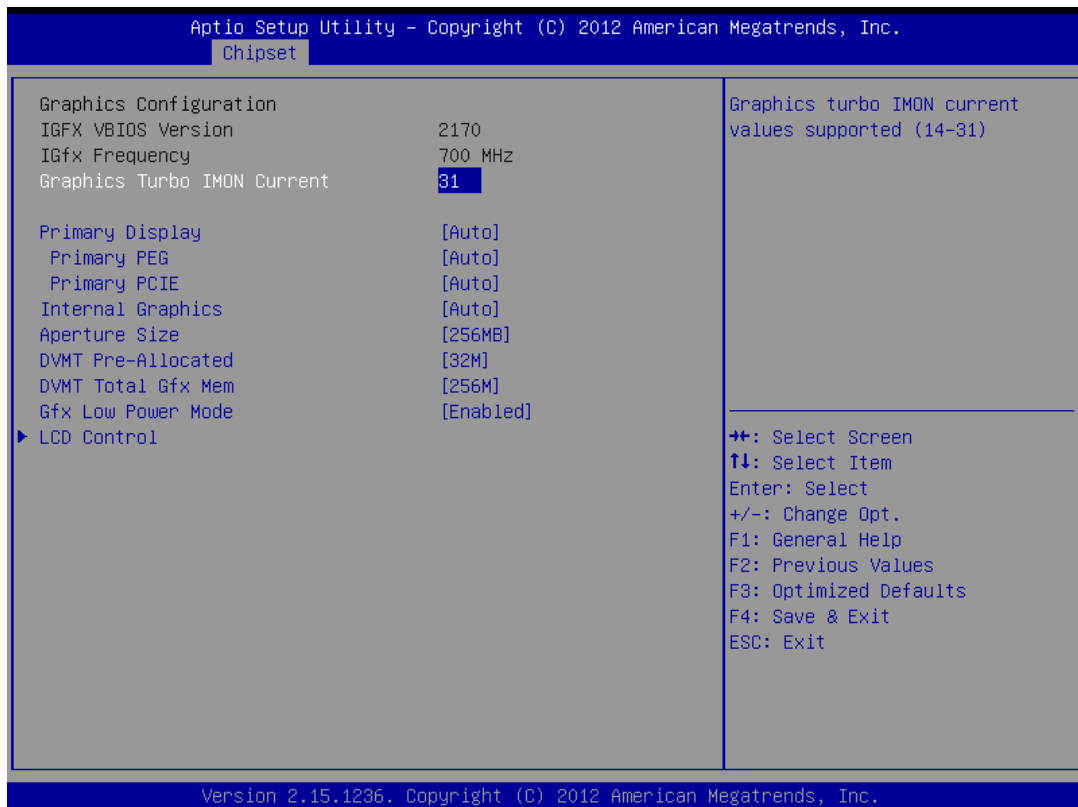

- **Graphics Turbo IMON Current**
Graphics turbo IMON current values supported (14-31).
- **Primary Display**
"Auto or IGFX or PEG" optimal to Primary Display.
- **Internal Graphics**
"Auto or Disable or Enable" Internal Graphics.
- **Aperture Size**
Aperture size optimal between 128MB, 256MB, or 512MB.
- **DVMT Pre-Allocated**
DVMT pre-allocated (fixed) Graphics memory size optimal from 32M to 1024M.
- **DVMT Total Gfx Mem**
DVMT Total Gfx Mem optimal Between 128M, 256M or MAX.
- **Gfx Low Power Mode**
This item allows users to enable or disable IGD low power mode.

LCD Control



- **Primary IGFX Boot Display [VBIOS Default]**
Select the video device which will be activated during POST. Secondary boot display selection will appear based on customer's selection.

Note! *The triple display can only working PASS under Windows 7, and the 2nd and 3rd display can not work under DOS.*



- **LVDS Panel Type**
LVDS Panel Type selection.
- **LVDS VESA/JEIDA Select**
LVDS VESA/JEIDA Selection.
- **Backlight Signal Control**
Switch Backlight Signal Control for PWM or LINEAR.
- **LVDS/eDP Select**
Select the Active LFP Configuration.

Here is 2-3 displays combination table and all of these combinations are verified and tested properly already.

BIOS Setting Primary/Secondary	BIOS	DOS	Windows
CRT	PASS	PASS	PASS
HDMI	PASS	PASS	PASS
DP1	PASS	PASS	PASS
DP2	PASS	PASS	PASS
LVDS	PASS	PASS	PASS
EDP	PASS	PASS	PASS
VGA+HDMI	PASS	N/A	PASS
VGA+DP1	PASS	N/A	PASS
VGA+DP2	PASS	N/A	PASS
VGA+EDP	PASS	N/A	PASS
DP1+DP2	PASS	N/A	PASS
HDMI+DP2	PASS	N/A	PASS
DP1+EDP	PASS	N/A	PASS
HDMI+EDP	PASS	N/A	PASS
DP2+EDP	PASS	N/A	PASS
DP1+LVDS	PASS	N/A	PASS
HDMI+LVDS	PASS	N/A	PASS
DP2+LVDS	PASS	N/A	PASS
VGA+DP1+DP2	N/A	N/A	PASS
VGA+HDMI+DP2	N/A	N/A	PASS
VGA+DP1+EDP	N/A	N/A	PASS
VGA+DP1+LVDS	N/A	N/A	PASS
VGA+HDMI+EDP	N/A	N/A	PASS
VGA+HDMI+LVDS	N/A	N/A	PASS
VGA+DP2+EDP	N/A	N/A	PASS
VGA+DP2+LVDS	N/A	N/A	PASS
DP1+DP2+LVDS	N/A	N/A	PASS
DP1+DP2+EDP	N/A	N/A	PASS
HDMI+DP2+LVDS	N/A	N/A	PASS
HDMI+DP2+EDP	N/A	N/A	PASS

3.2.3.5 DMI Configuration

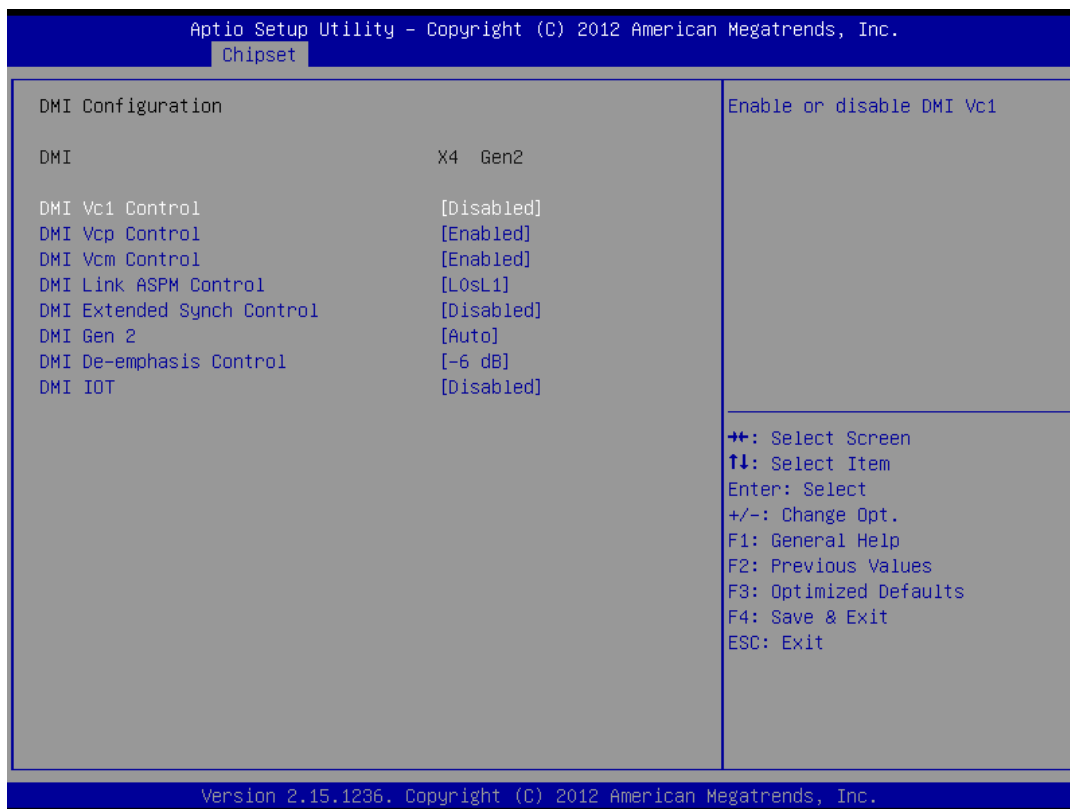

- **DMI Vc1 Control**
This item allows users to enable or disable DMI Vc1.
- **DMI Vcp Control**
This item allows users to enable or disable DMI Vcp.
- **DMI Vcm Control**
This item allows users to enable or disable DMI Vcm.
- **DMI Link ASPM Control**
This item allows users to select power management control.
- **DMI Extended Synch Control**
This item allows users to enable or disable DMI Extended Synch.
- **DMI Gen 2**
This item allows users to select DMI speed.
- **DMI De-emphasis Control**
Configure the De-emphasis control on DMI.
- **DMI IOT**
This item allows users to enable or disable DMI IOT.

3.2.3.6 NB PCIe Configuration

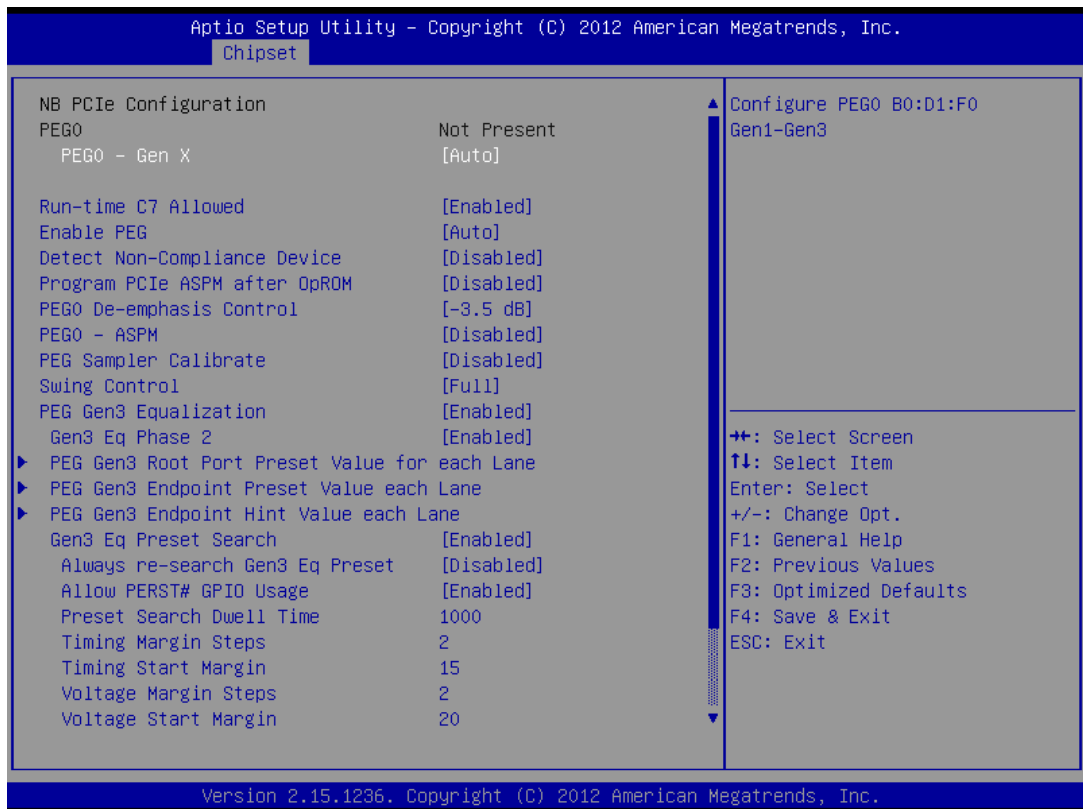

- **PEG0 - Gen x**
"Auto, Enable or Disable" PEG0 - Gen x
- **Run-time C7 Allowed**
Enable or Disable the entry to C7 state. Don't enable this feature until you have all the appropriate Save/Restore Controller/Endpoint state.
- **Enable PEG**
"Auto, Enable or Disable" Enable PEG.
- **Detect Non-Compliance Device**
Detect Non-Compliance PCI Express Device in PEG.
- **Program PCIe ASPM after OpROM**
Enabled: PCIe ASPM will be programmed after OpROM
Disabled: PCIe ASPM will be programmed before OpROM
- **PEG0 De-emphasis Control**
Configure the De-emphasis control on PEG0.
- **PEG0 ASPM**
Control ASPM support for the PEG Device. This has no effect if PEG is not the currently active device.
- **PEG Sampler Calibrate**
This item allows users to enable or disable PEG sampler calibrate function
- **Swing Control**
Perform PEG Swing Control, on IVB C0 and Later.
- **PEG Gen3 Equalization**
This item allows users to enable or disable PEG Gen3 Equalization function.
- **Gen3 Eq Phase 2**
This item allows users to enable or disable Gen3 Eq Phase 2 function.

- **Gen3 Eq Preset search**
This item allows users to enable or disable Gen3 Eq Preset search function.
- **Always research Gen3 Eq Preset**
This item allows users to enable or disable research Gen3 Eq Preset function.
- **Allow PERST# GPIO Usage**
This item allows users to enable or disable Allow PERST# GPIO function.

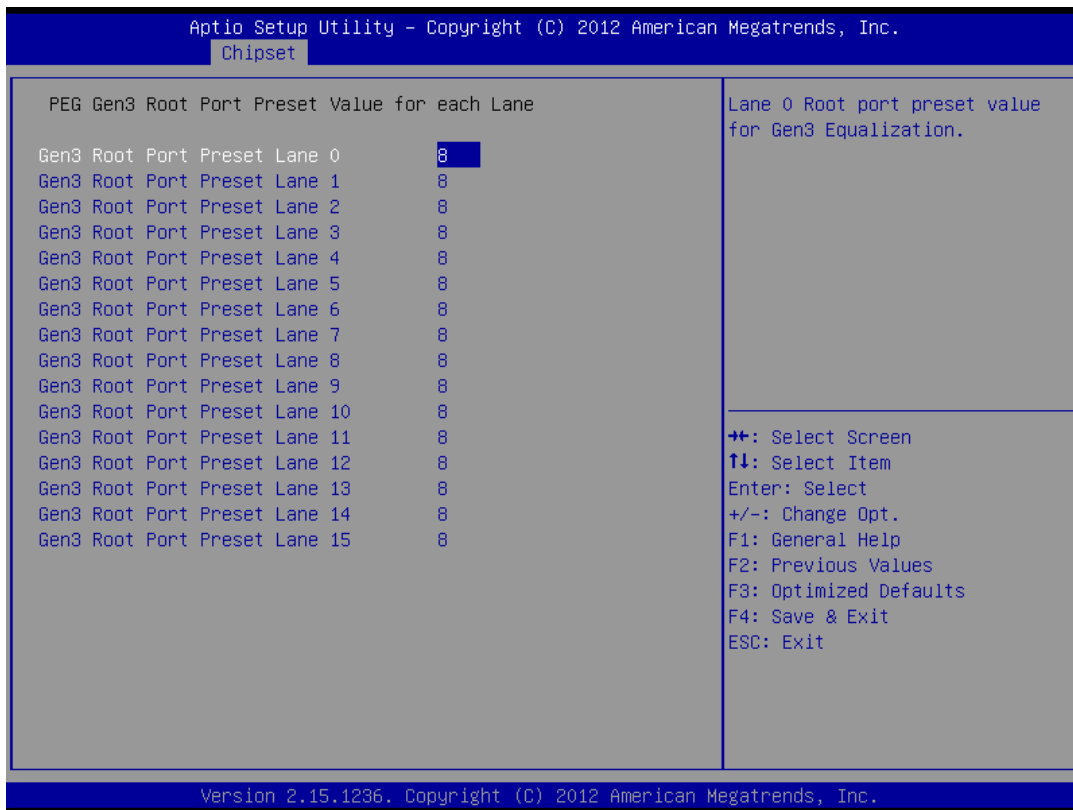

Lan 0 ~ 15 Root port preset value for Gen3 Equalization.

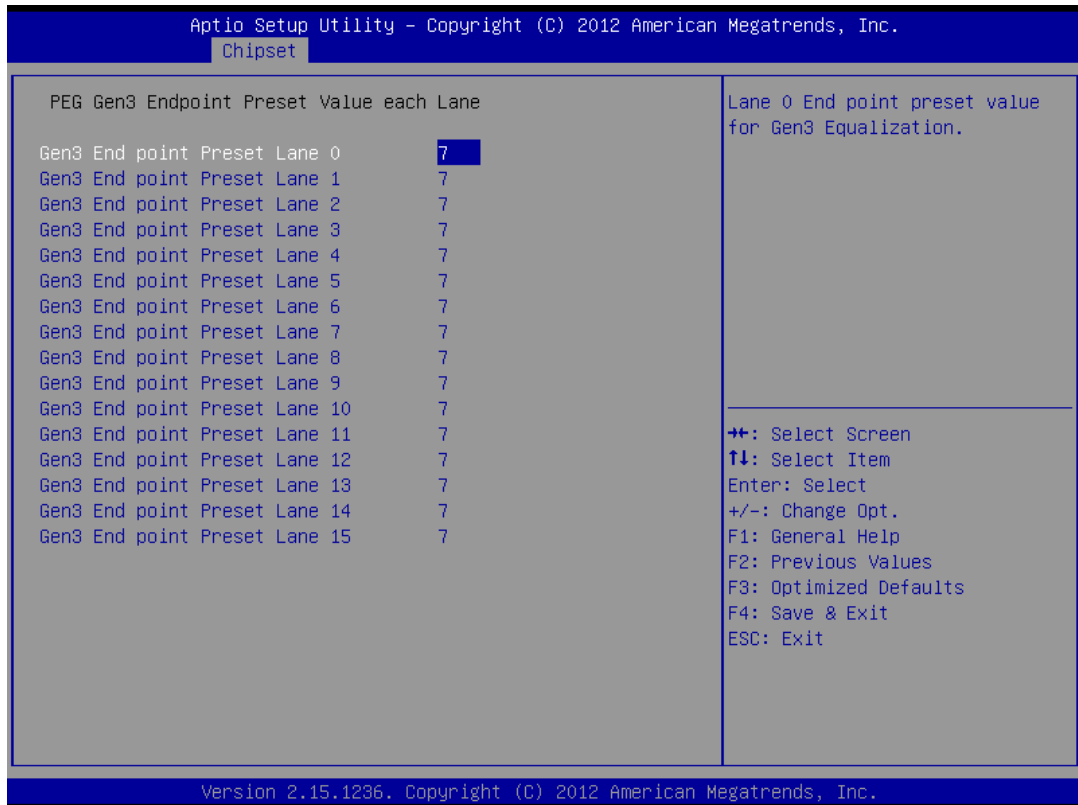

Lan 0 ~ 15 End point preset value for Gen3 Equalization.

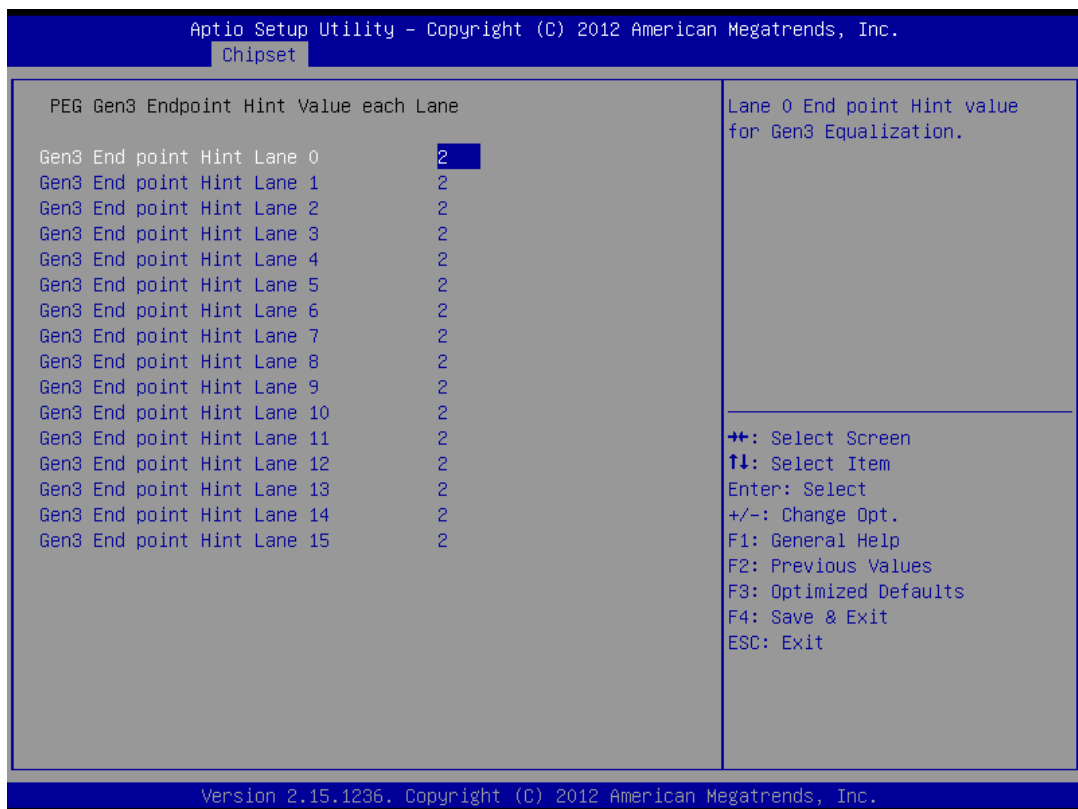

Lan 0 ~ 15 End point Hint value for Gen3 Equalization.

3.2.3.7 Memory Information

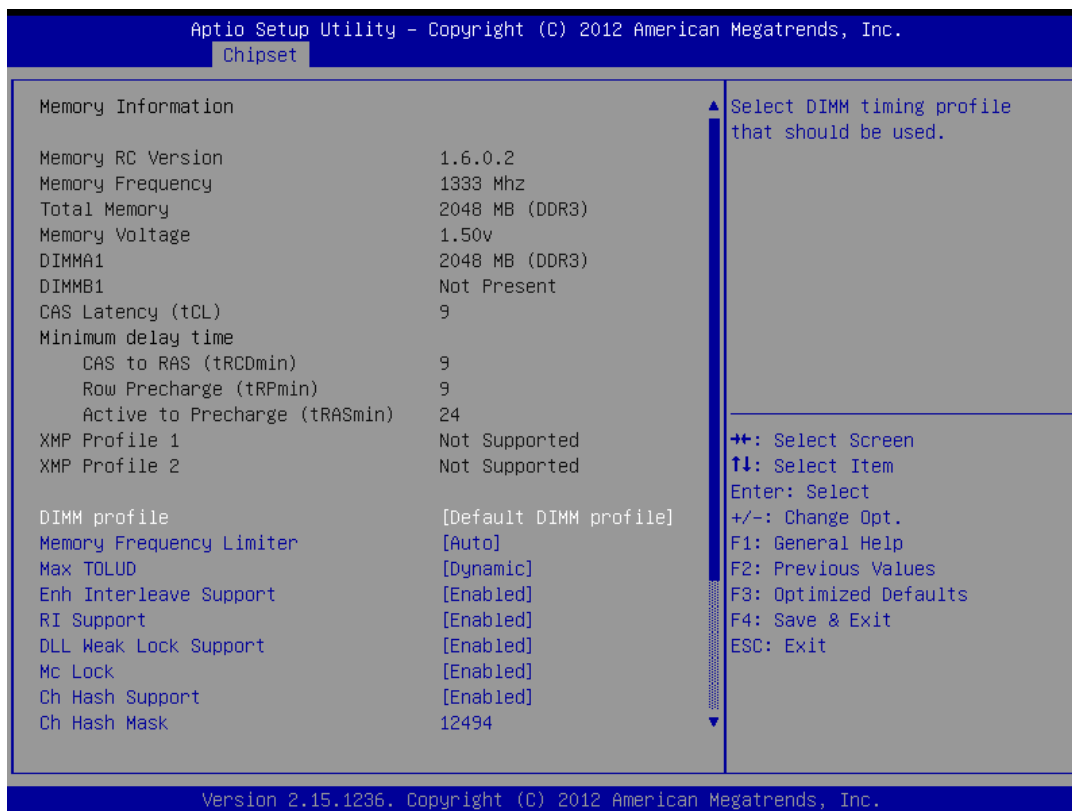

- **DIMM profile**
Select DIMM timing profile that should be used.
- **Memory Frequency Limiter**
Maximum Memory Frequency selection in MHz.
- **Max TOLUD**
This item allows users to select the maximum TOLUD.
- **Enh Interleave Support**
This item allows users to enable or disable EnH Interleave function.
- **RI Support**
This item allows users to enable or disable RI support function.
- **DLL Weak Lock Support**
This item allows users to enable or disable DLL Weak Lock Support function.
- **Mc Lock**
This item allows users to enable or disable Mc Lock function.
- **Ch Hash Support**
This item allows users to enable or disable Ch Hash function.
- **Ch Hash Mask**
Set the BIT(s) to be included in the XOR function. NOTE: BIT mask corresponds to BITS[19:6]

3.2.4 Boot

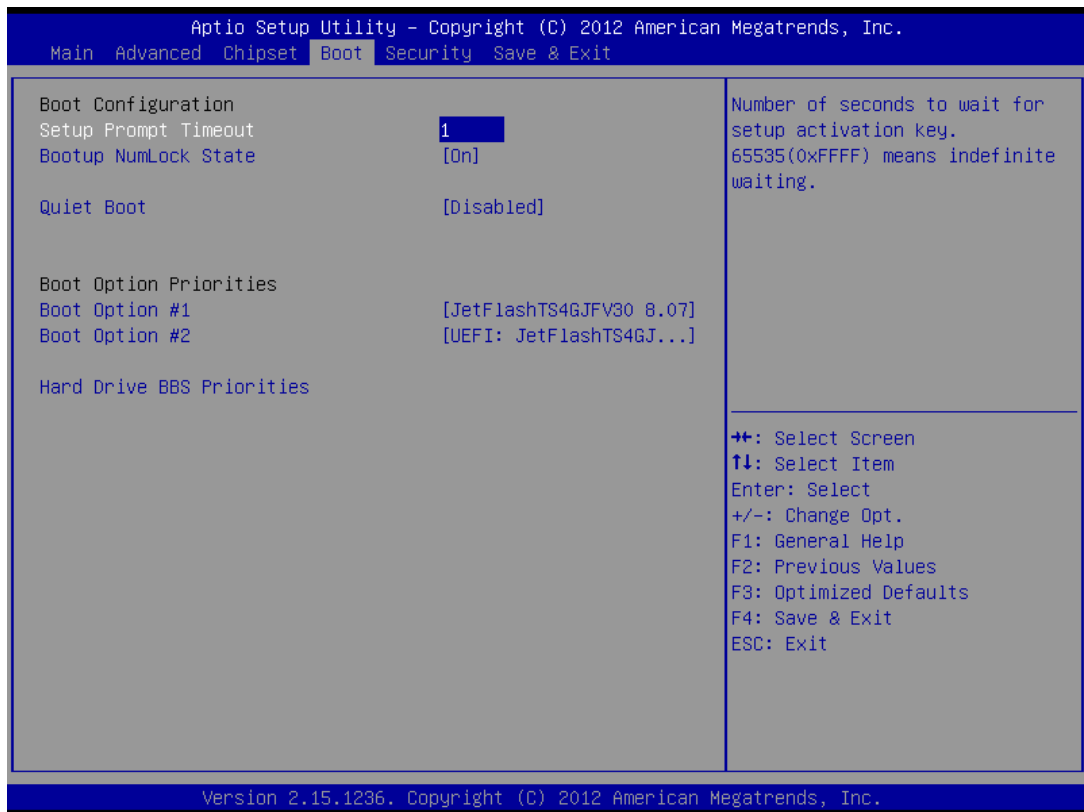

- **Setup Prompt Timeout**
This item allows you to change number of seconds to wait for setup activation key.
- **Bootup NumLock State**
Select the Power-on state for Numlock.
- **Quiet Boot**
If this option is set to Disabled, the BIOS display normal POST messages. If Enabled, an OEM Logo is shown instead of POST messages.
- **Boot Option Priorities**
Set the system boot order.

3.2.5 Security

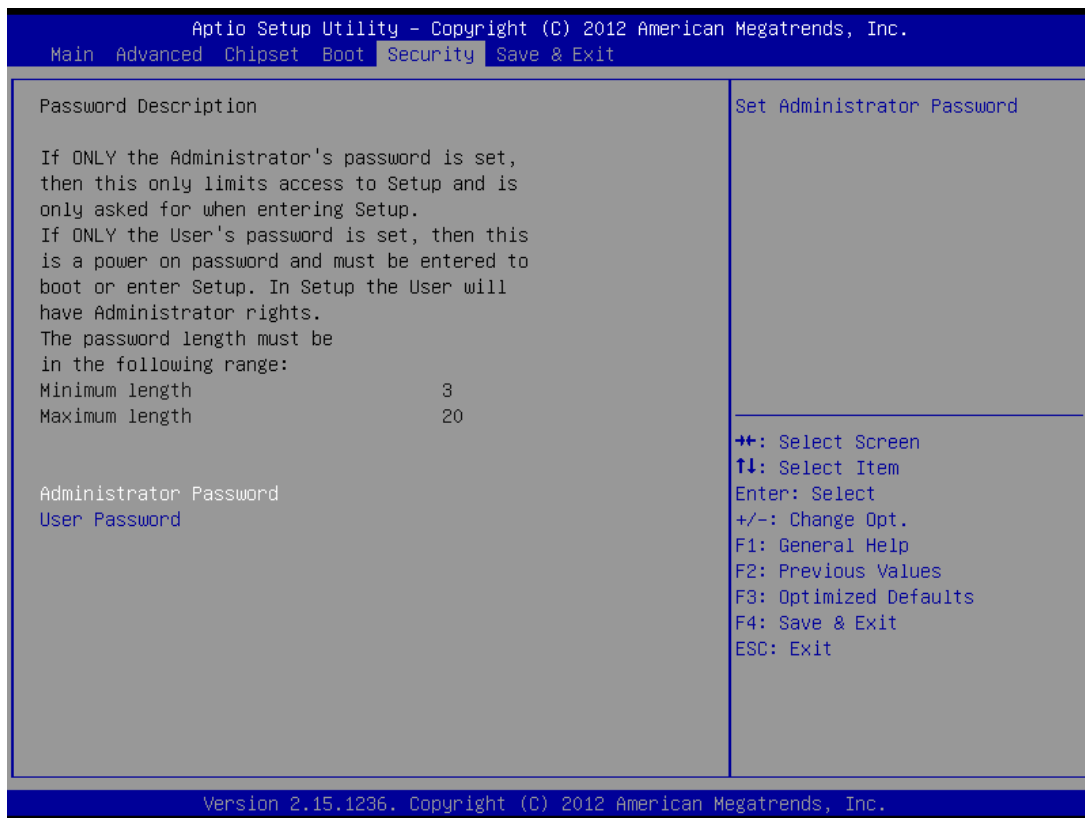

Select Security Setup from the AIMB-274 Setup main BIOS setup menu. All Security Setup options, such as password protection and virus protection are described in this section. To access the sub menu for the following items, select the item and press<Enter>: Change Administrator / User Password.

3.2.6 Save & Exit



- **Save Changes and Exit**
This item allows you to exit system setup after saving changes.
- **Discard Changes and Exit**
This item allows you to exit system setup without saving any changes.
- **Save Changes and Reset**
This item allows you to reset the system after saving the changes.
- **Discard Changes and Reset**
This item allows you to rest system setup without saving any changes.
- **Save Changes**
This item allows you to save changes done so far to any of the options.
- **Discard Changes**
This item allows you to discard changes done so far to any of the options.
- **Restore Defaults**
This item allows you to restore/load default values for all the options.
- **Save as User Defaults**
This item allows you to save the changes done so far as user defaults.
- **Restore User Defaults**
This item allows you to restore the user defaults to all the options.
- **Boot Override**
Boot device selection can override your boot priority.
- **Lauch EFI Shell from filesystem device**
Attempts to Launch EFI Shell application (Shellx64.efi) from one of the available filesystem devices.

Chapter 4

Software Introduction
& Service

4.1 Introduction

The mission of Advantech Embedded Software Services is to "Enhance quality of life with Advantech platforms and Microsoft® Windows® embedded technology." We enable Windows® Embedded software products on Advantech platforms to more effectively support the embedded computing community. Customers are freed from the hassle of dealing with multiple vendors (hardware suppliers, system integrators, embedded OS distributors) for projects. Our goal is to make Windows® Embedded Software solutions easily and widely available to the embedded computing community.

4.2 Value-Added Software Services

Software API: An interface that defines the ways by which an application program may request services from libraries and/or operating systems. Provides not only the underlying drivers required but also a rich set of user-friendly, intelligent and integrated interfaces, which speeds development, enhances security and offers add-on value for Advantech platforms. It plays the role of catalyst between developer and solution, and makes Advantech embedded platforms easier and simpler to adopt and operate with customer applications.

4.2.1 Software API

4.2.1.1 Control

GPIO



General Purpose Input/Output is a flexible parallel interface that allows a variety of custom connections. It allows users to monitor the level of signal input or set the output status to switch on/off the device. Our API also provide Programmable GPIO, which allows developers to dynamically set the GPIO input or output status.

SMBus



SMBus is the System Management Bus defined by Intel Corporation in 1995. It is used in personal computers and servers for low-speed system management communications. The SMBus API allows a developer to interface a embedded system environment and transfer serial messages using the SMBus protocols, allowing multiple simultaneous device control.

4.2.1.2 Display

Brightness Control



The Brightness Control API allows a developer to access embedded devices and easily control brightness.

Backlight



The Backlight API allows a developer to control the backlight (screen) on/off in embedded devices.

4.2.1.3 Monitor

Watchdog



A watchdog timer (WDT) is a device that performs a specific operation after a certain period of time if something goes wrong and the system does not recover on its own. A watchdog timer can be programmed to perform a warm boot (restarting the system) after a certain number of seconds.

Hardware Monitor



The Hardware Monitor (HWM) API is a system health supervision API that inspects certain condition indexes, such as fan speed, temperature and voltage.

4.2.1.4 Power Saving

CPU Speed



Makes use of Intel SpeedStep technology to save power consumption. The system will automatically adjust the CPU speed depending on the system loading.

System Throttling



Refers to a series of methods for reducing power consumption in computers by lowering the clock frequency. This API allows the user to adjust the clock from 87.5% to 12.5%.

4.2.2 Software Utility

BIOS Flash

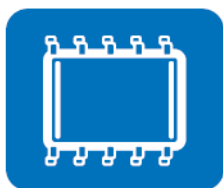

The BIOS Flash utility allows customers to update the flash ROM BIOS version, or use it to back up current BIOS by copying it from the flash chip to a file on customers' disk. The BIOS Flash utility also provides a command line version and an API for fast implementation into customized applications.

Embedded Security ID



The embedded application is the most important property of a system integrator. It contains valuable intellectual property, design knowledge and innovation, but it is easy to copy! Embedded Security ID utility provides reliable security functions for customers to secure their application data within the embedded BIOS.

Monitoring



The Monitoring is a utility for customer to monitor the system health, like voltage, CPU and system temperature and fan speed. These items are important to a device, if the critical errors occur and are not solved immediately, permanent damage may be caused.

eSOS



The eSOS is a small OS stored in BIOS ROM. It will boot up in case of a main OS crash. It will diagnose the hardware status, and then send an e-mail to the designated administrator. The eSOS also provide for remote connection via Telnet server and FTP server so the administrator can attempt to rescue the system. Note: This function requires BIOS customization.

Chapter 5

Chipset Software
Installation Utility

5.1 Before You Begin

To facilitate the installation of the enhanced display drivers and utility software, read the instructions in this chapter carefully. The drivers for the AIMB-274 are located on the software installation CD. The driver in the folder of the driver CD will guide and link you to the utilities and drivers under a Windows system. Updates are provided via Service Packs from Microsoft*.

Note! *The files on the software installation CD are compressed. Do not attempt to install the drivers by copying the files manually. You must use the supplied SETUP program to install the drivers.*



Before you begin, it is important to note that most display drivers need to have the relevant software application already installed in the system prior to installing the enhanced display drivers. In addition, many of the installation procedures assume that you are familiar with both the relevant software applications and operating system commands. Review the relevant operating system commands and the pertinent sections of your application software's user manual before performing the installation.

5.2 Introduction

The Intel® Chipset Software Installation (CSI) utility installs the Windows INF files that outline to the operating system how the chipset components will be configured. This is needed for the proper functioning of the following features:

- Core PCI PnP services
- IDE Ultra ATA 100/66/33 and Serial ATA interface support
- USB support
- Identification of Intel® chipset components in the Device Manager

Note! *This utility is used for the following versions of Windows, and it has to be installed **before** installing all the other drivers:*



- Windows 7 (32-bit)
- Windows 7 (64-bit)
- Windows 8 (32-bit)
- Windows 8 (64-bit)

5.3 Windows 7/8 Driver Setup

1. Insert the driver CD into your system's CD-ROM drive. You can see the driver folder items. Navigate to the "Intel Chip" folder and click "infinst_autol.exe" to complete the installation of the driver.

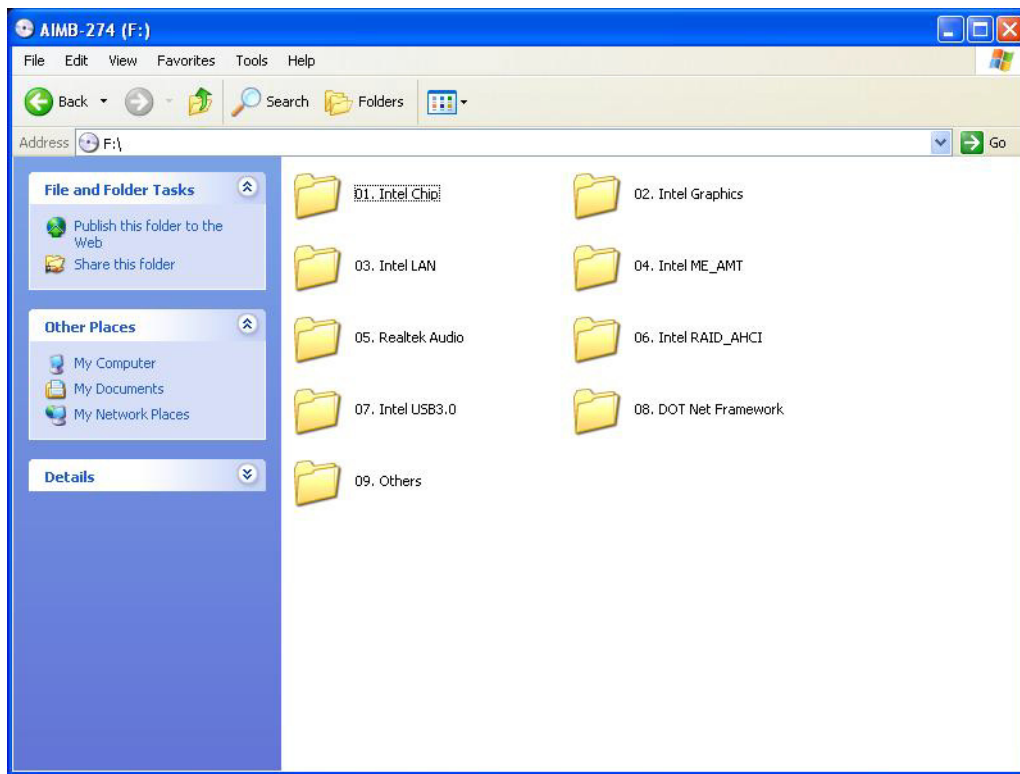

Chapter 6

VGA Setup

6.1 Introduction

The 4th Gen Intel Core i processors are embedded with an integrated graphics controller. You need to install the VGA driver to enable the function.

Optimized integrated graphic solution: With Intel Graphics Flexible, it supports versatile display options and 32-bit 3D graphics engine. Dual independent display, enhanced display modes for widescreen flat panels for extend, twin, and clone dual display mode, and optimized 3D support deliver an intensive and realistic visual experience.

6.2 Windows 7/8

Note! Before installing this driver, make sure the CSI utility has been installed in your system. See Chapter 5 for information on installing the CSI utility.



Insert the driver CD into your system's CD-ROM drive. You can see the driver folders items. Navigate to the "Intel Graphics" folder and click "setup.exe" to complete the installation of the drivers for Windows 7 and Windows 8.

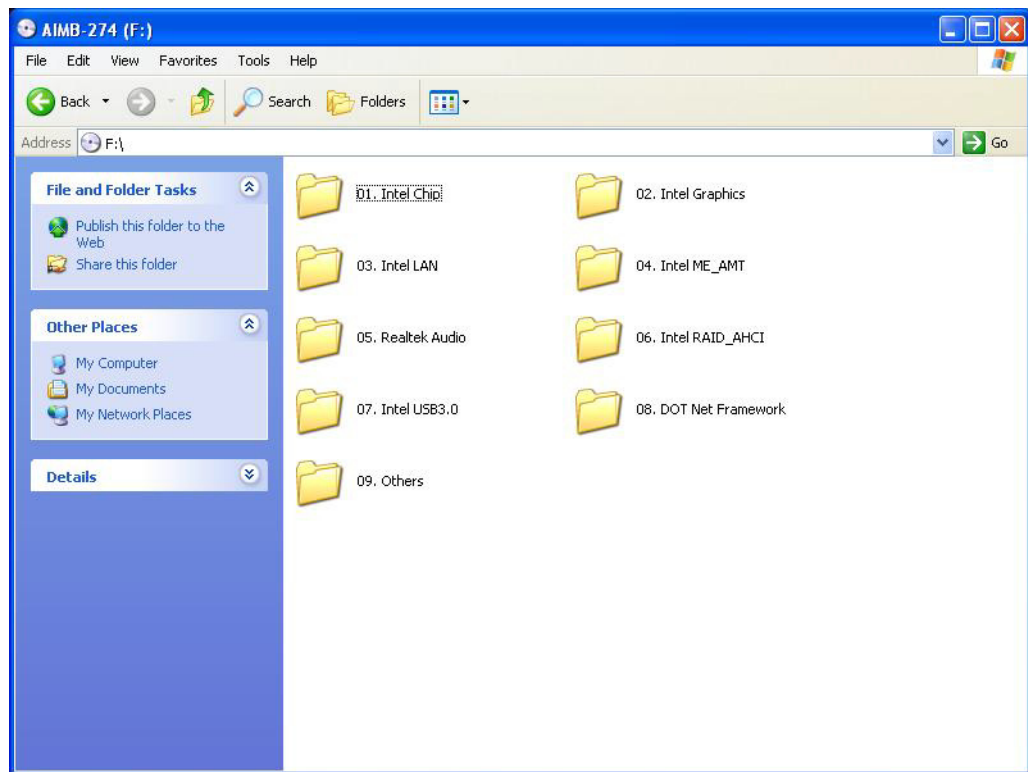

Chapter 7

LAN Configuration

7.1 Introduction

The AIMB-274 has dual Gigabit Ethernet LANs via dedicated PCI Express x1 lanes (Intel I217LM (LAN1) and I211AT (LAN2)) that offer bandwidth of up to 500 MB/sec, eliminating the bottleneck of network data flow and incorporating Gigabit Ethernet at 1000 Mbps.

7.2 Features

- Integrated 10/100/1000 Mbps transceiver
- 10/100/1000 Mbps triple-speed MAC
- High-speed RISC core with 24-KB cache
- On-chip voltage regulation
- Wake-on-LAN (WOL) support
- PCI Express X1 host interface

7.3 Installation

Note! *Before installing the LAN drivers, make sure the CSI utility has been installed on your system. See Chapter 5 for information on installing the CSI utility.*



The AIMB-274's Intel I217LM (LAN1) and I211AT (LAN2) Gigabit integrated controllers support all major network operating systems. However, the installation procedure varies from system to system. Please find and use the section that provides the driver setup procedure for the operating system you are using.

7.4 Windows® 7/8 Driver Setup (Intel I217LM / I211AT)

Insert the driver CD into your system's CD-ROM drive. Select the “Intel LAN” folder then navigate to the directory for your OS.

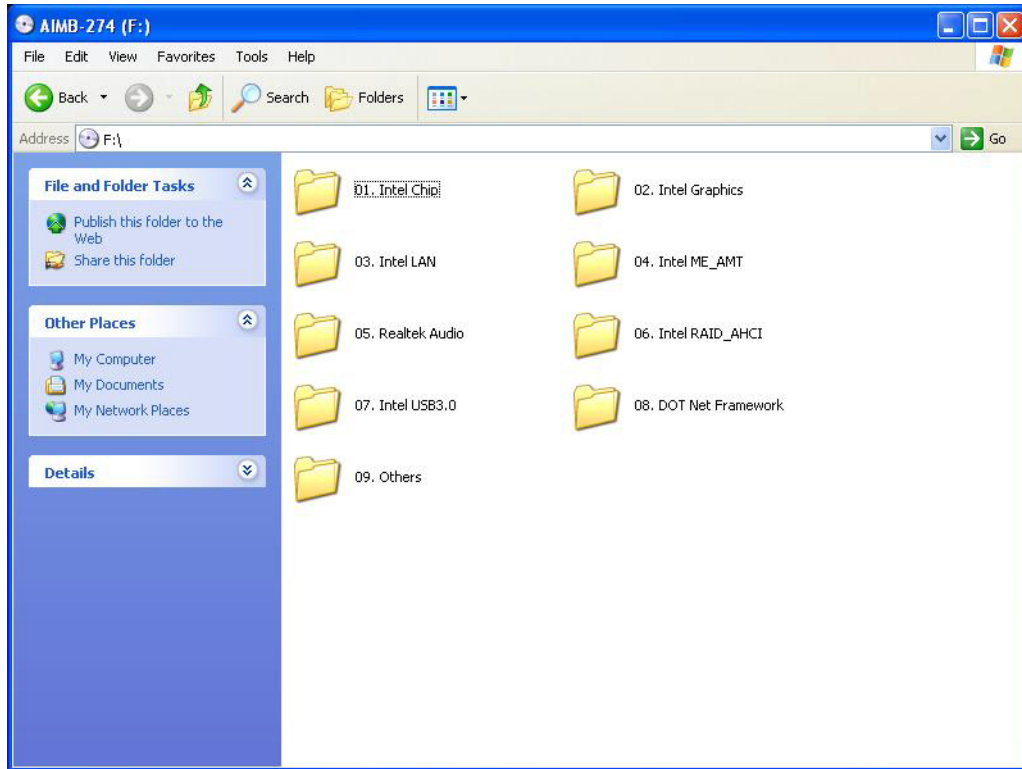

Appendix **A**

I/O Pin Assignments

A.1 SATA Signal Connector (SATA1~SATA4)

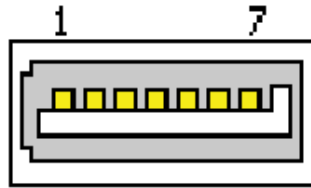

Table A.1: SATA connector (SATA1~SATA4)

Pin	Signal
1	GND
2	TX+
3	TX-
4	GND
5	RX-
6	RX+
7	GND

A.2 External SATA/USB 2.0 Combo Connector (ESATA1)

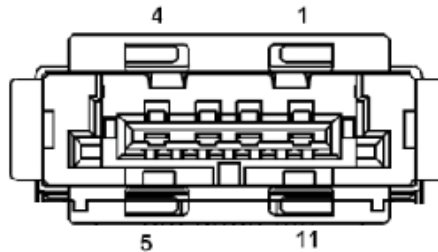

Table A.2: External SATA/USB 2.0 Combo Connector (ESATA1)

Pin	USB Signal	Pin	ESATA Signal
1	+5V	5	GND
2	D-	6	TX+
3	D+	7	TX-
4	GND	8	GND
		9	RX-
		10	RX+
		11	GND

A.3 SATA Power Connector (SATA_PWR1, SATA_PWR2)

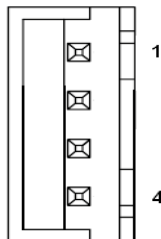

Table A.3: SATA Power Connector (SATA_PWR1, SATA_PWR2)

Pin	Signal
1	+5V
2	GND
3	GND
4	+12V

A.4 MINIPCIIE and mSATA Connector (MINIPCIIE1)

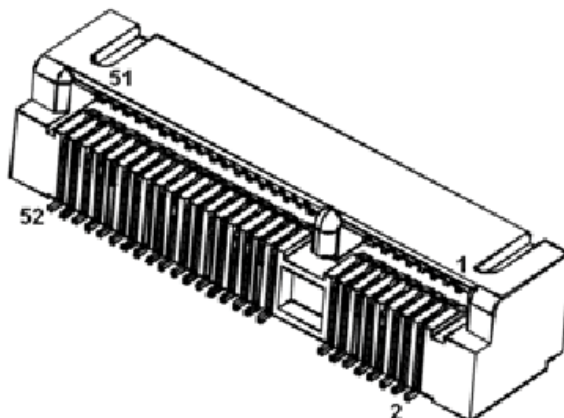

Table A.4: MINIPCIIE (MINIPCIIE1)

Pin	Signal	Pin	Signal
1	WAKE#	2	+3.3Vaux
3	Reserved	4	GND
5	Reserved	6	+1.5V
7	CLKREQ#	8	Reserved
9	GND	10	Reserved
11	REFCLK-	12	Reserved
13	REFCLK+	14	Reserved
15	GND	16	Reserved

Table A.4: MINIPCIE (MINIPCIE1)

17	Reserved	18	GND
19	Reserved	20	DISABLE#
21	DETECT#	22	RESET#
23	PCIE_RX+	24	+3.3Vaux
25	PCIE_RX-	26	GND
27	GND	28	+1.5V
29	GND	30	SMB_CLK
31	PCIE_TX-	32	SMB_DATA
33	PCIE_TX+	34	GND
35	GND	36	USB_D-
37	GND	38	USB_D+
39	+3.3Vaux	40	GND
41	+3.3Vaux	42	Reserved
43	V1.2_DETECT#	44	LED_WLAN#
45	Reserved	46	Reserved
47	Reserved	48	+1.5V
49	Reserved	50	GND
51	MSATA_DETECT#	52	+3.3Vaux

Table A.5: mSATA Connector (MINIPCIE1)

Pin	Signal	Pin	Signal
1	Reserved	2	+3.3V
3	Reserved	4	GND
5	Reserved	6	+1.5V
7	Reserved	8	Reserved
9	GND	10	Reserved
11	Reserved	12	Reserved
13	Reserved	14	Reserved
15	GND	16	Reserved
17	Reserved	18	GND
19	Reserved	20	Reserved
21	DETECT#	22	Reserved
23	RX+	24	+3.3V
25	RX-	26	GND
27	GND	28	+1.5V
29	GND	30	SMB_CLK
31	TX-	32	SMB_DATA

Table A.5: mSATA Connector (MINIPCI1)

33	TX+	34	GND
35	GND	36	Reserved
37	GND	38	Reserved
39	+3.3V	40	GND
41	+3.3V	42	Reserved
43	Reserved	44	Reserved
45	Reserved	46	Reserved
47	Reserved	48	+1.5V
49	Reserved	50	GND
51	MSATA_DETECT#	52	+3.3V

A.5 MINIPCI Connector (MINIPCI2)

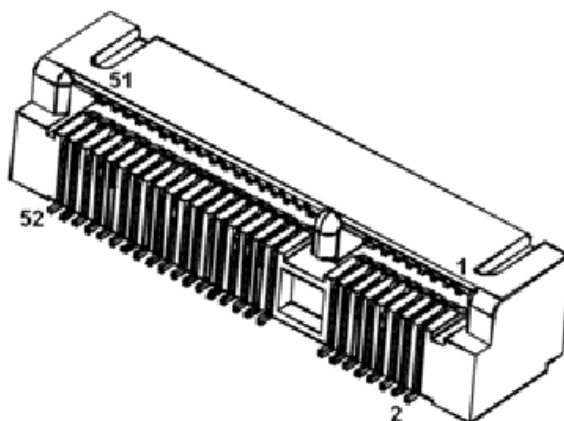
**Table A.6: MINIPCI Connector (MINIPCI2)**

Pin	Signal	Pin	Signal
1	WAKE#	2	+3.3Vaux
3	Reserved	4	GND
5	Reserved	6	+1.5V
7	CLKREQ#	8	SIM_PWR
9	GND	10	SIM_DATA
11	REFCLK-	12	SIM_CLK
13	REFCLK+	14	SIM_RESET
15	GND	16	SIM_VPP
17	Reserved	18	GND
19	Reserved	20	DISABLE#
21	DETECT#	22	RESET#
23	PCIE_RX-	24	+3.3Vaux

Table A.6: MINIPCI Connector (MINIPCI2)

25	PCIE_RX+	26	GND
27	GND	28	+1.5V
29	GND	30	SMB_CLK
31	PCIE_TX-	32	SMB_DATA
33	PCIE_TX+	34	GND
35	GND	36	USB_D-
37	GND	38	USB_D+
39	+3.3Vaux	40	GND
41	+3.3Vaux	42	Reserved
43	V1.2_DETECT#	44	LED_WLAN#
45	CLINK_CLK	46	Reserved
47	CLINK_DATA	48	+1.5V
49	CLINK_RESET#	50	GND
51	Reserved	52	+3.3Vaux

A.6 SIM Card Socket (SIM1)

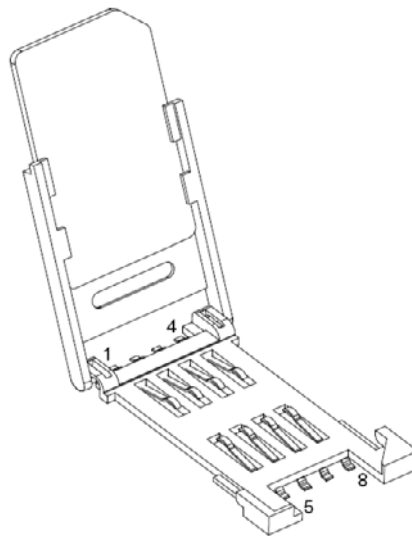
**Table A.7: SIM Card Socket (SIM1)**

Pin	Signal	Pin	Signal
1	UIM_PWR	5	GND
2	UIM_RESET	6	UIM_VPP
3	UIM_CLK	7	UIM_DATA
4	Reserved	8	Reserved

A.7 Display Port and HDMI Common Connector (DP-HDMI1)

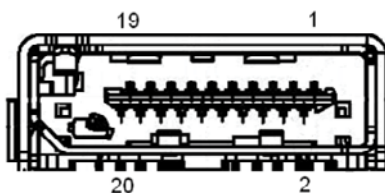

Table A.8: Display Port and HDMI Common Connector (DP-HDMI1)

Pin	Display Port Signal	HDMI Signal
1	Lane 0+	TMDS Data2+
2	GND	GND
3	Lane 0-	TMDS Data2-
4	Lane 1+	TMDS Data1+
5	GND	GND
6	Lane 1-	TMDS Data1-
7	Lane 2+	TMDS Data0+
8	GND	GND
9	Lane 2-	TMDS Data0-
10	Lane 3+	TMDS Clock+
11	GND	GND
12	Lane 3-	TMDS Clock+-
13	GND	CEC
14	Reserved	Reserved
15	AUX+	SCL
16	GND	SDA
17	AUX-	GND
18	DP_HPD	+5V
19	GND	HDMI_HPD
20	+3.3V	NC
21	DP_DETECT#	DP_DETECT#

A.8 Display Port Connector (DP2)

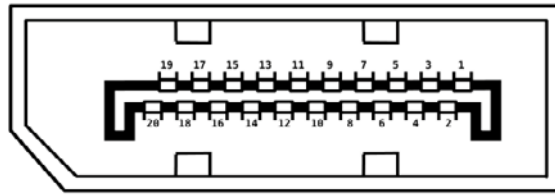

Table A.9: Display Port Connector (DP2)

Pin	Signal	Pin	Signal
1	Lane 0+	2	GND
3	Lane 0-	4	Lane 1+
5	GND	6	Lane 1-
7	Lane 2+	8	GND
9	Lane 2-	10	Lane 3+
11	GND	12	Lane 3-
13	DP_DETECT#	14	GND
15	AUX+	16	GND
17	AUX-	18	DP_HPD
19	GND	20	+3.3V

A.9 VGA Connector (VGA1)

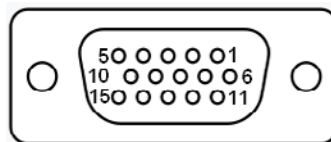

Table A.10: VGA Connector (VGA1)

Pin	Signal	Pin	Signal
1	RED	9	+5V
2	GREEN	10	GND
3	BLUE	11	Reserved
4	Reserved	12	SDA
5	GND	13	HSYNC
6	VGA_FORCE_ON	14	VSYNC
7	GND	15	SCL
8	GND		

A.10 LVDS Panel Connector (LVDS1)

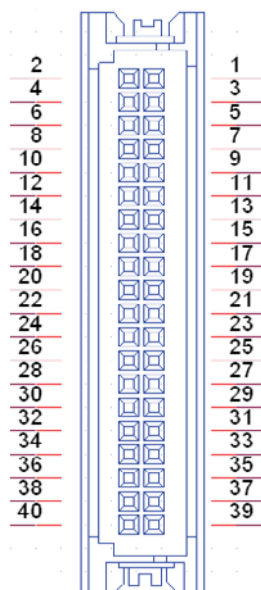

Table A.11: LVDS Panel Connector (LVDS1)

Pin	Signal	Pin	Signal
1	VDD	2	VDD
3	LVDS_DET#	4	GND
5	VDD	6	VDD
7	OD0-	8	ED0-
9	OD0+	10	ED0+
11	GND	12	GND
13	OD1-	14	ED1-
15	OD1+	16	ED1+
17	GND	18	GND
19	OD2-	20	ED2-
21	OD2+	22	ED2+
23	GND	24	GND
25	OCK-	26	ECK-
27	OCK+	28	ECK+
29	GND	30	GND
31	DDC_CLK	32	DDC_DAT
33	GND	34	GND
35	OD3-	36	ED3-
37	OD3+	38	ED3+
39	LVDS_ENBKL	40	VCON

A.11 LVDS Backlight Inverter Power Connector (INV1)

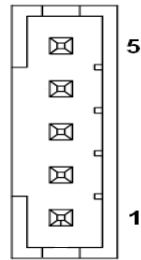

Table A.12: LVDS Backlight Inverter Power Connector (INV1)

Pin	Signal
1	+12V
2	GND
3	BKL_EN
4	BKL_CTRL
5	+5V

A.12 Embedded Display Port Connector (EDP1)

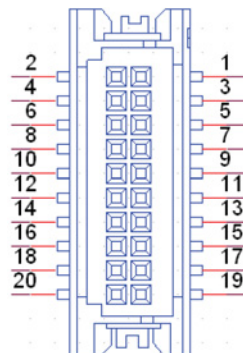

Table A.13: Embedded Display Port Connector (EDP1)

Pin	Signal	Pin	Signal
1	GND	2	GND
3	Lane 0-	4	Lane 3-
5	Lane 0+	6	Lane 3+
7	GND	8	Reserved
9	Lane 1-	10	GND
11	Lane 1+	12	AUX-
13	GND	14	AUX+
15	Lane 2-	16	GND
17	Lane 2+	18	EDP_HPDP

Table A.13: Embedded Display Port Connector (EDP1)

19	VDD	20	VDD
----	-----	----	-----

A.13 USB Header (USB56,USB78, USB910)

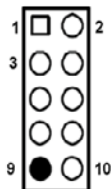
**Table A.14: USB Header (USB56, USB78, USB910)**

Pin	Signal	Pin	Signal
1	+5V	2	+5V
3	D0-	4	D1-
5	D0+	6	D1+
7	GND	8	GND
9	KEY	10	NC

A.14 RJ45+USB 3.0 Stack Connector (LAN1_USB12, LAN2_USB34)

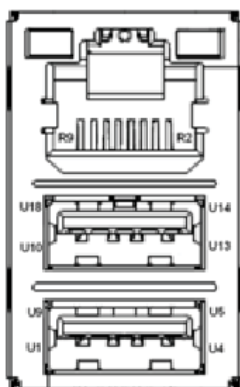
**Table A.15: RJ45**

Pin	Signal	Pin	Signal
R2	MDI_0+	R6	MDI_2+
R3	MDI_0-	R7	MDI_2-
R4	MDI_1+	R8	MDI_3+
R5	MDI_1-	R9	MDI_3-

Table A.16: USB

Pin	Signal	Pin	Signal
U1	+5V	U10	+5V
U2	D0-	U11	D1-
U3	D0+	U12	D1+
U4	GND	U13	GND
U5	RX0-	U14	RX1-
U6	RX0+	U15	RX1+
U7	GND	U16	GND
U8	TX0-	U17	TX1-
U9	TX0+	U18	TX1+

A.15 CI-E x16 Slot (PCIEX16_1)

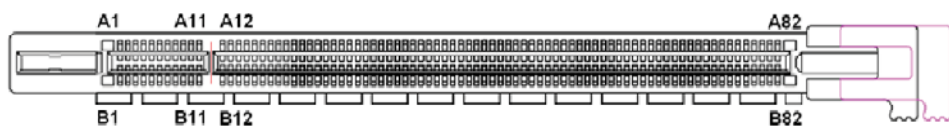
**Table A.17: PCI-E x 16 Slot (PCIEX16_1)**

Pin	Signal	Pin	Signal
B1	+12V	A1	PRSNT1#
B2	+12V	A2	+12V
B3	+12V	A3	+12V
B4	GND	A4	GND
B5	SMB_CLK	A5	Reserved
B6	SMB_DATA	A6	Reserved
B7	GND	A7	Reserved
B8	+3.3V	A8	Reserved
B9	Reserved	A9	+3.3V
B10	+3.3VAUX	A10	+3.3V
B11	WAKE#	A11	PWRGD
B12	Reserved	A12	GND
B13	GND	A13	REFCLK+
B14	TX0+	A14	REFCLK-
B15	TX0-	A15	GND
B16	GND	A16	RX0+
B17	Reserved	A17	RX0-

Table A.17: PCI-E x 16 Slot (PCIEX16_1)			
B18	DETECT#	A18	GND
B19	TX1+	A19	CONFIG1
B20	TX1-	A20	GND
B21	GND	A21	RX1+
B22	GND	A22	RX1-
B23	TX2+	A23	GND
B24	TX2-	A24	GND
B25	GND	A25	RX2+
B26	GND	A26	RX2-
B27	TX3+	A27	GND
B28	TX3-	A28	GND
B29	GND	A29	RX3+
B30	Reserved	A30	RX3-
B31	Reserved	A31	GND
B32	GND	A32	CONFIG2
B33	TX4+	A33	Reserved
B34	TX4-	A34	GND
B35	GND	A35	RX4+
B36	GND	A36	RX4-
B37	TX5+	A37	GND
B38	TX5-	A38	GND
B39	GND	A39	RX5+
B40	GND	A40	RX5-
B41	TX6+	A41	GND
B42	TX6-	A42	GND
B43	GND	A43	RX6+
B44	GND	A44	RX6-
B45	TX7+	A45	GND
B46	TX7-	A46	GND
B47	GND	A47	RX7+
B48	Reserved	A48	RX7-
B49	GND	A49	GND
B50	TX8+	A50	Reserved
B51	TX8-	A51	GND
B52	GND	A52	RX8+
B53	GND	A53	RX8-
B54	TX9+	A54	GND

Table A.17: PCI-E x 16 Slot (PCIEX16_1)

B55	TX9-	A55	GND
B56	GND	A56	RX9+
B57	GND	A57	RX9-
B58	TX10+	A58	GND
B59	TX10-	A59	GND
B60	GND	A60	RX10+
B61	GND	A61	RX10-
B62	TX11+	A62	GND
B63	TX11-	A63	GND
B64	GND	A64	RX11+
B65	GND	A65	RX11-
B66	TX12+	A66	GND
B67	TX12-	A67	GND
B68	GND	A68	RX12+
B69	GND	A69	RX12-
B70	TX13+	A70	GND
B71	TX13-	A71	GND
B72	GND	A72	RX13+
B73	GND	A73	RX13-
B74	TX14+	A74	GND
B75	TX14-	A75	GND
B76	GND	A76	RX14+
B77	GND	A77	RX14-
B78	TX15+	A78	GND
B79	TX15-	A79	GND
B80	GND	A80	RX15+
B81	Reserved	A81	RX15-
B82	Reserved	A82	GND

A.16 HD Digital Audio Interface (SPDIF1)

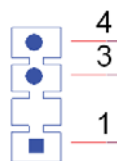
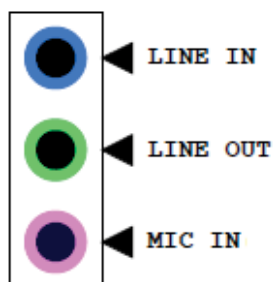

Table A.18: HD Digital Audio Interface (SPDIF1)

Pin	Signal
1	+5V
3	SPDIF OUT
4	GND

A.17 HD Analog Audio Interface (AUDIO1, FPAUD1)

**Table A.19: AUDIO1**

Pin	Signal
1	MIC IN
2	LINE OUT
3	LINE IN

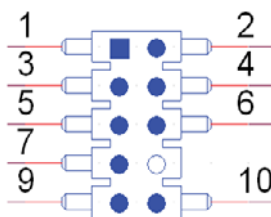
**Table A.20: FPAUD1**

Pin	Signal	Pin	Signal
1	MIC IN L	2	GND
3	MIC IN R	4	FPAUD_DETECT#
5	LINE OUT R	6	SENSE R1
7	SENSE	8	KEY
9	LINE OUT L	10	SENSE R2

A.18 Audio Amplifier Output Connector (AMP1)

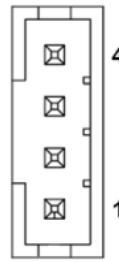

Table A.21: Audio Amplifier Output Connector (AMP1)

Pin	Signal
1	R+
2	R-
3	L-
4	L+

A.19 General Purpose I/O Pin Header (GPIO1)

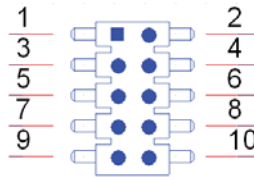

Table A.22: General Purpose I/O Pin Header (GPIO1)

Pin	Signal	Pin	Signal
1	GPIO0	2	GPIO4
3	GPIO1	4	GPIO5
5	GPIO2	6	GPIO6
7	GPIO3	8	GPIO7
9	+3.3V	10	GND

A.20 SPI BIOS Flash Socket (SPI1)

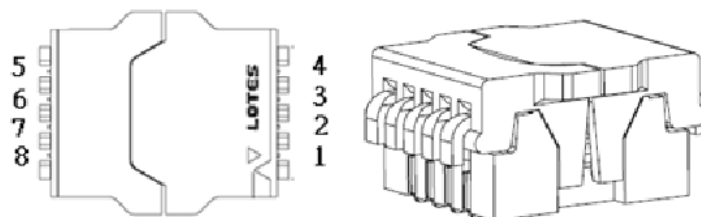
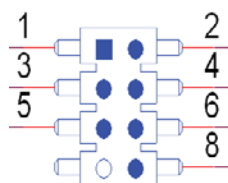

Table A.23: SPI BIOS Flash Socket (SPI1)

Pin	Signal	Pin	Signal
1	CS#	5	MOSI
2	MISO	6	SCK
3	WP# / IO2	7	HOLD# / IO3
4	GND	8	+3.3V

A.21 SPI Programming Pin Header (SPI_CN1)

**Table A.24: SPI Programming Pin Header (SPI_CN1)**

Pin	Signal	Pin	Signal
1	+3.3V	2	GND
3	CS#	4	SCK
5	MISO	6	MOSI
7	KEY	8	NC

A.22 Low Pin Count Header (LPC1)

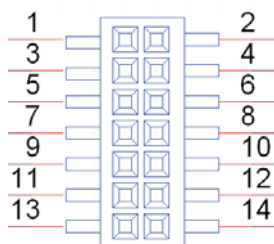
**Table A.25: Low Pin Count Header (LPC1)**

Pin	Signal	Pin	Signal
1	CLK_33M	2	AD1
3	RESET#	4	AD0
5	FRAME#	6	+3.3V
7	AD3	8	GND
9	AD2	10	SMB_CLK
11	SERIRQ	12	SMB_DATA

Table A.25: Low Pin Count Header (LPC1)

13	+5VSB	14	+5V
----	-------	----	-----

A.23 SMBUS Programming I/F for Vcore Controller (JSMB1)

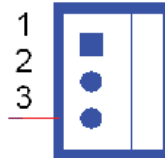

Table A.26: SMBUS Programming I/F for Vcore Controller (JSMB1)

Pin	Signal
1	SMB_CLK
2	SMB_DATA
3	GND

A.24 Case-Open Detect Connector (JCASE1)

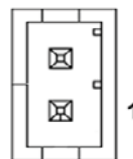

Table A.27: Case-Open Detect Connector (JCASE1)

Pin	Signal
1	INTRUDER#
2	GND

A.25 PS/2 Keyboard and Mouse Connector (KBMS1)

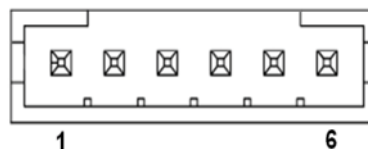

Table A.28: PS/2 Keyboard and Mouse Connector (KBMS1)

Pin	Signal
1	KB_CLK

Table A.28: PS/2 Keyboard and Mouse Connector (KBMS1)

2	KB DATA
3	MS CLK
4	GND
5	+5V
6	MS DATA

A.26 COM Port (COM1, COM2)

COM1:

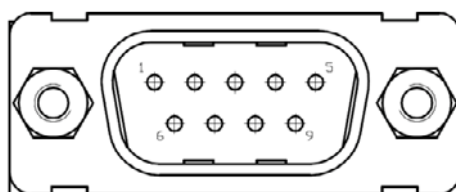
**Table A.29: COM Port 1**

Pin	Signal	Pin	Signal
1	DCD#	6	DSR#
2	RXD	7	RTS#
3	TXD	8	CTS#
4	DTR#	9	RI#
5	GND		

COM2:

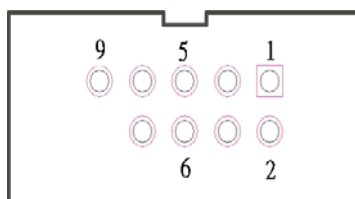
**Table A.30: COM Port 2**

Pin	Signal	Pin	Signal
1	DCD# / 422 485 TX-	2	DSR#
3	RXD / 422 485 TX+	4	RTS#
5	TXD / 422 RX+	6	CTS#
7	DTR# / 422 RX-	8	RI#
9	GND		

A.27 CPU FAN Power Connector (CPUFAN1)

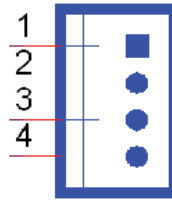

Table A.31: CPU FAN Power Connector (CPUFAN1)

Pin	Signal
1	GND
2	+12V
3	DETECT
4	PWM IN

A.28 SYSTEM FAN Power Connector (SYSFAN1, SYSFAN2)

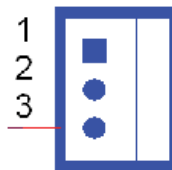

Table A.32: SYSTEM FAN Power Connector (SYSFAN1, SYSFAN2)

Pin	Signal
1	GND
2	FAN POWER
3	DETECT

A.29 ATX 12V Power Supply Connector (ATX12V1)

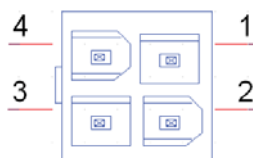

Table A.33: ATX 12V Power Supply Connector (ATX12V1)

Pin	Signal
-----	--------

Table A.33: ATX 12V Power Supply Connector (ATX12V1)

1	GND
2	GND
3	+12V
4	+12V

A.30 ATX Power Supply Connector(ATXPWR1)

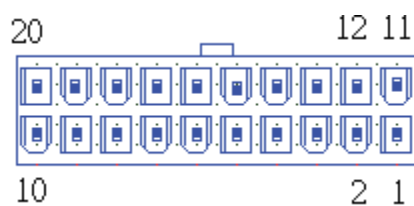
**Table A.34: ATX Power Supply Connector(ATXPWR1)**

Pin	Signal	Pin	Signal
1	+3.3V	11	+3.3V
2	+3.3V	12	-12V
3	GND	13	GND
4	+5V	14	PSOEN#
5	GND	15	GND
6	+5V	16	GND
7	GND	17	GND
8	POWER_OK	18	-5V
9	+5VSB	19	+5V
10	+12V	20	+5V

ADVANTECH

Enabling an Intelligent Planet

www.advantech.com

Please verify specifications before quoting. This guide is intended for reference purposes only.

All product specifications are subject to change without notice.

No part of this publication may be reproduced in any form or by any means, electronic, photocopying, recording or otherwise, without prior written permission of the publisher.

All brand and product names are trademarks or registered trademarks of their respective companies.

© Advantech Co., Ltd. 2013