

Part Number: WP7113SGC

Super Bright Green

### Features

- Low power consumption.
- Popular T-1 3/4 diameter package.
- General purpose leads.
- Reliable and rugged.
- Long life - solid state reliability.
- Available on tape and reel.
- RoHS compliant.

### Description

The Super Bright Green source color devices are made with Gallium Phosphide Green Light Emitting Diode.

### Package Dimensions

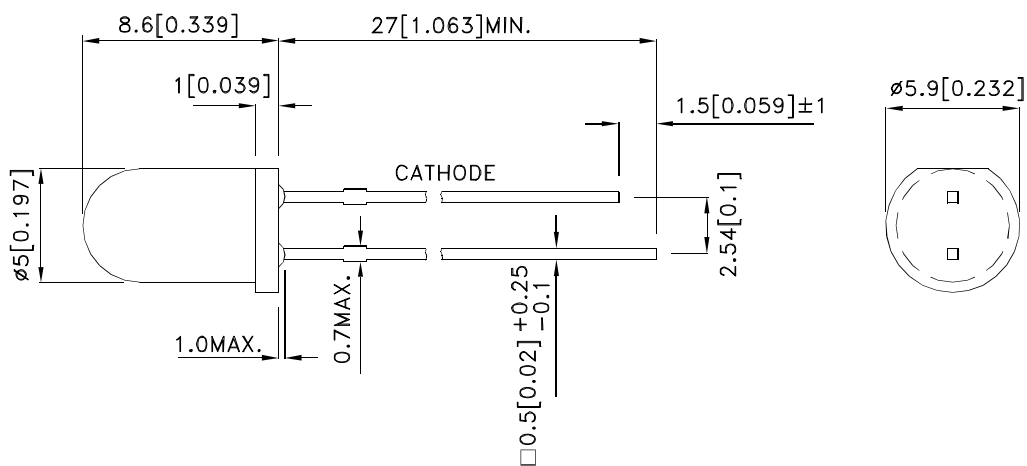

#### Notes:

1. All dimensions are in millimeters (inches).
2. Tolerance is  $\pm 0.25 (0.01")$  unless otherwise noted.
3. Lead spacing is measured where the leads emerge from the package.
4. The specifications, characteristics and technical data described in the datasheet are subject to change without prior notice.



## Selection Guide

Part No.	Dice	Lens Type	Iv (mcd) [2] @ 20mA		Viewing Angle [1]
			Min.	Typ.	2θ1/2
WP7113SGC	Super Bright Green (GaP)	Water Clear	120	240	20°

Notes:

1. θ1/2 is the angle from optical centerline where the luminous intensity is 1/2 of the optical peak value.
2. Luminous intensity/ luminous Flux: +/-15%.
3. Luminous intensity value is traceable to the CIE127-2007 compliant national standards.

## Electrical / Optical Characteristics at TA=25°C

Symbol	Parameter	Device	Typ.	Max.	Units	Test Conditions
$\lambda_{peak}$	Peak Wavelength	Super Bright Green	565		nm	I <sub>F</sub> =20mA
$\lambda_D$ [1]	Dominant Wavelength	Super Bright Green	568		nm	I <sub>F</sub> =20mA
$\Delta\lambda_{1/2}$	Spectral Line Half-width	Super Bright Green	30		nm	I <sub>F</sub> =20mA
C	Capacitance	Super Bright Green	15		pF	V <sub>F</sub> =0V;f=1MHz
V <sub>F</sub> [2]	Forward Voltage	Super Bright Green	2.2	2.5	V	I <sub>F</sub> =20mA
I <sub>R</sub>	Reverse Current	Super Bright Green		10	uA	V <sub>R</sub> = 5V

Notes:

1. Wavelength: +/-1nm.
2. Forward Voltage: +/-0.1V.
3. Wavelength value is traceable to the CIE127-2007 compliant national standards.

## Absolute Maximum Ratings at TA=25°C

Parameter	Super Bright Green	Units
Power dissipation	62.5	mW
DC Forward Current	25	mA
Peak Forward Current [1]	140	mA
Reverse Voltage	5	V
Operating/Storage Temperature	-40°C To +85°C	
Lead Solder Temperature [2]	260°C For 3 Seconds	
Lead Solder Temperature [3]	260°C For 5 Seconds	

Notes:

1. 1/10 Duty Cycle, 0.1ms Pulse Width.
2. 2mm below package base.
3. 5mm below package base.



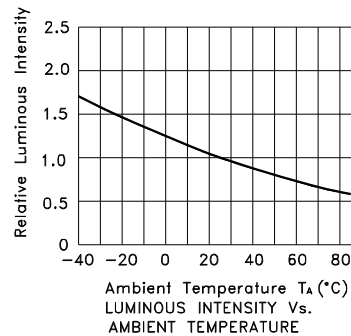
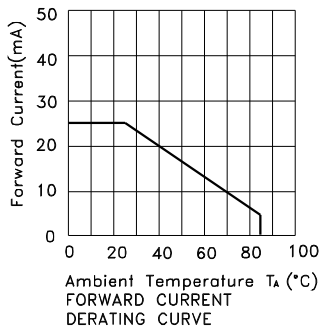
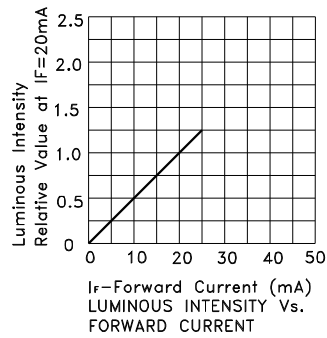

## Super Bright Green WP7113SGC

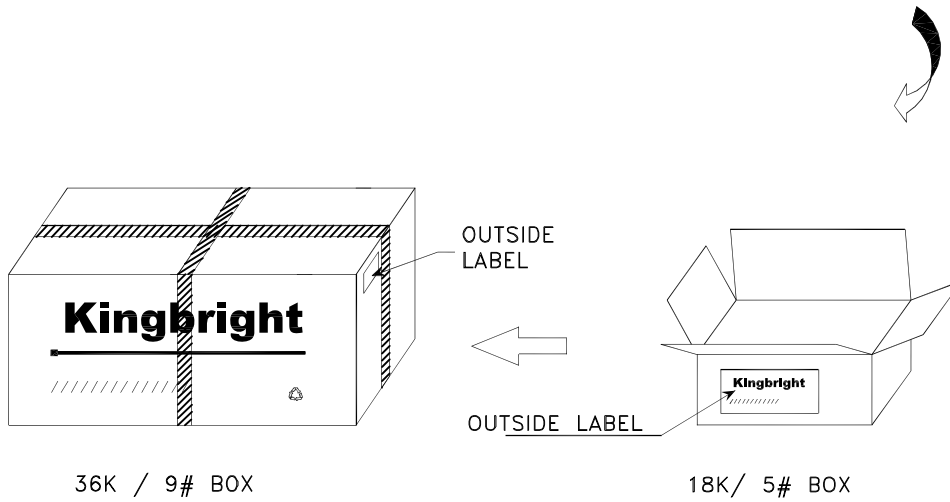
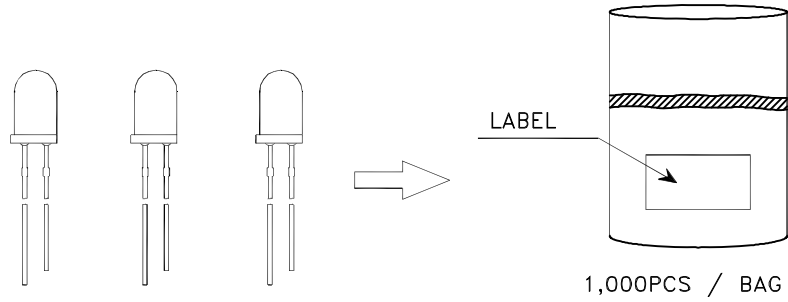

**PACKING & LABEL SPECIFICATIONS**

**WP7113SGC**



<h1>Kingbright</h1>		
P/NO: WP7113xxx		
QTY: 1000 pcs	Q.C.	Q C XX XX XXXX PASSED
S/N: XXXX		
CODE: XXX		
LOT NO:		
 xxxxxxxxxxxxxxxxxxxxxxxxxxxx		
RoHS Compliant		

## PRECAUTIONS

1. The lead pitch of the LED must match the pitch of the mounting holes on the PCB during component placement. Lead-forming may be required to insure the lead pitch matches the hole pitch. Refer to the figure below for proper lead forming procedures. (Fig. 1)

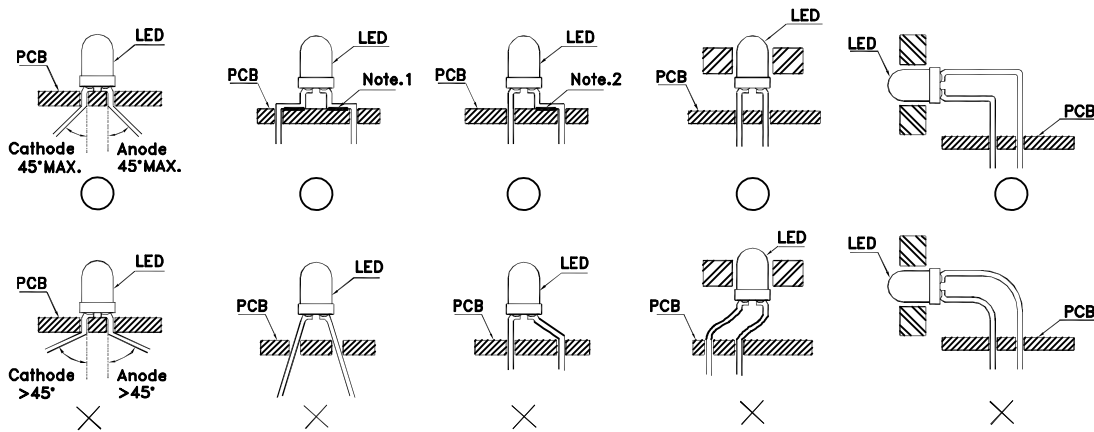

Fig.1

”○” Correct mounting method ”×” Incorrect mounting method

2. When soldering wire to the LED, use individual heat-shrink tubing to insulate the exposed leads to prevent accidental contact short-circuit. (Fig.2)
3. Use stand-offs (Fig.3) or spacers (Fig.4) to securely position the LED above the PCB.

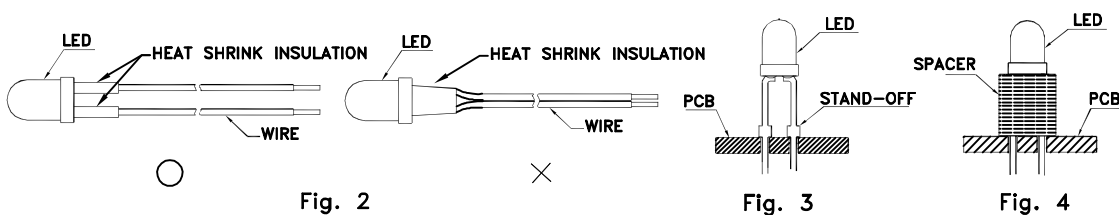

Fig. 2

Fig. 3

Fig. 4

4. Maintain a minimum of 2mm clearance between the base of the LED lens and the first lead bend. (Fig. 5 and 6)
5. During lead forming, use tools or jigs to hold the leads securely so that the bending force will not be transmitted to the LED lens and its internal structures. Do not perform lead forming once the component has been mounted onto the PCB. (Fig. 7)

6. Do not bend the leads more than twice. (Fig. 8)



7. During soldering, component covers and holders should leave clearance to avoid placing damaging stress on the LED during soldering.



8. The tip of the soldering iron should never touch the lens epoxy.

9. Through-hole LEDs are incompatible with reflow soldering.

10. If the LED will undergo multiple soldering passes or face other processes where the part may be subjected to intense heat, please check with Kingbright for compatibility.

11. Recommended Wave Soldering Profiles:



Notes:

1. Recommend pre-heat temperature of 105°C or less (as measured with a thermocouple attached to the LED pins) prior to immersion in the solder wave with a maximum solder bath temperature of 260°C
2. Peak wave soldering temperature between 245°C ~ 255°C for 3 sec (5 sec max).
3. Do not apply stress to the epoxy resin while the temperature is above 85°C.
4. Fixtures should not incur stress on the component when mounting and during soldering process.
5. SAC 305 solder alloy is recommended.
6. No more than one wave soldering pass.

All design applications should refer to Kingbright application notes available at <http://www.KingbrightUSA.com/ApplicationNotes>