

REFERENCE DESIGN KIT FEATURES

- IEC61000-3-2 Class D Standards Compliant
- Less than 10% Total Harmonic Distortion (115-230VAC/300W)
- Power Factor higher than 0.99 (115-230VAC/300W)
- Universal AC Input Voltage capability
- Fully regulated 388V DC bus
- Full load start-up, no minimum load requirements
- Current loop controlled soft-current limit protection for overpower limitation at minimum VAC
- Cycle-by-Cycle Peak Current Limit
- Output Over Voltage Protection
- Open Feedback Loop Protection
- 100kHz Switching Frequency

IR1155 PFC IC FEATURES

- PFC IC with “One Cycle Control”
- Continuous conduction mode boost type PFC
- Programmable switching frequency
- Average current mode control
- DC bus overvoltage protection (Dedicated)
- DC bus open feedback loop protection
- Cycle-by-cycle peak current limit (DC bus voltage foldback type)
- Soft-current limit protection
- VCC under voltage lockout
- Programmable soft-start
- Micropower startup & sleep mode (user-initiated)
- 1.5A peak gate drive

Product Summary

AC Input Voltage	85-264VAC
AC Input Line Frequency	47-63Hz
DC Bus Output Voltage	388V +/- 4%
Maximum output power	300W
Minimum Load Requirement	None
Power Factor (115-230VAC/300W)	>0.99
Total Harmonic Distortion (115-230VAC/300W)	<10%
Start-up time	50ms

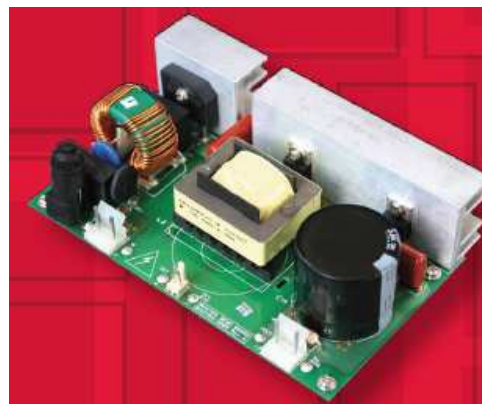

Introduction

IRAC1155-300W is a full function AC-DC reference design showcasing the operation of IR1155 PFC IC in a continuous conduction mode boost converter for achieving power factor correction, sub-10% harmonic current distortion and EN61000-3-2 Class D harmonic current limits standard compliance. Designed to be operated from 85-264VAC universal input voltage, IRAC1155-300W delivers 300W continuous output power via a fully regulated 388V DC bus. Thanks to IR1155 PFC IC, the reference design is rendered with a very high level of safety against system abnormalities such as DC bus voltage loop feedback loss, system overcurrent & overvoltage protection. The IRAC1155-300W reference design is an excellent design example that can be seamlessly imported & integrated by system designers that require a high-performance PFC stage at the AC-DC front-end of their designs in a variety of applications.

Table of Contents

Introduction1
Description of Hardware & Key Operating Features4
Hardware Installation & Operating Procedure5
Performance Characterization6
IRAC1155-300W Schematics13
IRAC1155-300W Bill of Materials (BoM)14
IRAC1155-300W Components Layout15

List of Figures

Figure 1 IRAC1155-300W test set-up.....5
Figure 2 Efficiency over line/load of IRAC1155-300W6
Figure 3. Power factor vs. Line/Load Variation of IRAC1155-300W7
Figure 4. THD across 85-264VAC for IRAC1155-300W7
Figure 5. 2X AC frequency ripple in DC bus capacitor at 85VAC, 300W9
Figure 6. 2X AC frequency ripple in DC bus capacitor at 264VAC, 300W9

Safety Precautions



ATTENTION: The ground potential of the IRAC1155-300W is biased to a negative DC bus voltage potential. In order to be able to safely measure voltage waveform by oscilloscope, the use of an isolation transformer at the AC input is recommended. Though floating the ground potential of the scope is often practiced, it is not recommended. Failure to follow these guidelines so may result in personal injury or death.



ATTENTION: The IRAC1155-300W system contains dc bus capacitors & capacitors on the rectified AC line (C3, C14, C18), which take time to discharge after removal of main supply. Remove and lock out power from the IRAC1155-300W board before you attempt to disconnect or reconnect wires or perform service. Wait at least one minute after removing power to discharge the capacitor voltages. Do not attempt to service the reference design until all capacitor voltages have discharged to zero. Failure to do so may result in bodily injury or death.



ATTENTION: Only personnel familiar with the IRAC1155-300W system should plan or implement the installation, start-up, and subsequent maintenance of the system. Failure to comply may result in personal injury and/or equipment damage.



ATTENTION: The surface temperatures of the IRAC1155-300W board & heatsink may become hot, which may cause injury. A fan is recommended to cool the board whenever operating at the full rated power for prolonged periods.



ATTENTION: The IRAC1155-300W system contains ESD (Electrostatic Discharge) sensitive parts and assemblies. Static control precautions are required when installing, testing, servicing or repairing this assembly. Component damage may result if ESD control procedures are not followed. If you are not familiar with static control procedures, reference applicable ESD protection handbook and guideline.



ATTENTION: An incorrectly applied or installed board can result in component damage or reduction in product life. Wiring errors, supplying an incorrect AC supply, or excessive ambient temperatures may result in system malfunction.

Description of Hardware & Key Operating Features

The key features of the IRAC1155-300W hardware are listed below. The user is referred to IRAC1155-300W schematics provided later in the document for the following discussions and also to “300W PFC Converter Design Example” section in IR1155 Application Note AN-1166 for the design details.

AC Input Stage (before bridge rectifier)

- EMI Stage is comprised of 2X 0.47uF X-capacitors & one common-mode EMI choke with 2.8mH rated magnetic impedance.
- Inrush current limitation is provided by a NTC (negative thermal coefficient) resistor offering 1ohm impedance at 25C.
- A 250V, 5A fuse is included for current protection.

Power Stage

- Bridge Rectifier: 600V, 10A bridge rectifier (D1) is employed.
- Boost Inductor: A 850uH Boost inductor (L2) based on Cool-Mu EE40 core is employed. With 850uH of boost inductance, the ripple current factor is about 0.18 (18% current ripple) near peak of AC sinusoid at 85VAC, 300W (DC bus voltage=388V).
- Boost Switch & Gate Drive Circuit: CoolMOS 650V/165mohm (Q1) is used for boost switch. With +/1.5A gate drive capability, IR1155S can directly drive the MOSFET without using external buffer. Localized gate resistor & diode networks (R7, R9, D7) is used to preferentially adjust turn-on & turn-off dV/dt. Turn-on is slower to control reverse recovery behavior of boost diode. Finally a Schottky diode, D6 between GATE & COM pins of IR1155 is used to clamp any negative voltage spikes that can cause IC latch-up.
- Boost Diode: A 600V, 8A Q-speed diode (D3) is employed as boost diode.
- DC Bus Capacitor: 270uF, 450V capacitor (C14) is employed on the DC bus for acceptable ripple at 300W power rating at 388VDC. A 1W, 470kohm bleed resistor (R10) is used across C10 to discharge the bus voltage.
- Current Sense Resistor: IRAC1155-300W employs a 70mohm, 3W current sense resistor (Rs).

CAUTION: If the user attempts to modify the power level of the PCB by changing the current sense resistor, attention must be paid to the component ratings - semiconductors (bridge rectifier, boost switch, boost diode), boost inductor, fuse, DC bus capacitor – and system thermal performance (use a fan to cool heatsink, run at lower ambient temperature etc).

- Current Monitoring: A Jumper at the bottom side of the PCB is provided for monitoring the PFC switch current.

Vcc bias

- User should provide IR1155 VCC bias using an external DC supply connected to J2. The recommended DC supply voltage range is 12V~15V.

IR1155 IC Control Circuit

- VFB Pin – The DC bus voltage is programmed using the resistor divider comprised of R11, R3 & R6. By adjusting R6, user can modify the DC bus voltage. Increasing R6 will decrease DC bus voltage. Decreasing R6 will increase DC bus voltage.
- OVP Pin – OVP pin resistor divider (R13, R5 & R20) program the over-voltage protection level.

IRAC1155-300W Default Set-point	Typical Level
DC Bus Regulation Voltage	388V
Overvoltage Protection Set-point (OVP pin)	419V
Overvoltage Protection Reset Set-point (OVP pin)	402V

- **FREQ Pin** – The capacitor that connected between FREQ pin and COM (C15) defines the switching frequency of IR1155. The frequency can be programmed between 48kHz to 200kHz with capacitor value from 500pF to 2nF. In this design, a 1nF cap is used and the switching frequency is set to 100kHz. Please refer to IR1155S datasheet to get the frequency setup curve.
- **VCOMP Pin** – C5, C11 & R8 are involved in the following functions:
 - Voltage loop compensation (location of pole & zero in voltage loop feedback response & phase margin)
 - C11 primarily determines the system soft-start time during start-up
 The user is recommended to review “Voltage Loop Compensation” section in AN-1166 before modifying any of these components, since such an explanation is outside the scope of this document.
- **ISNS Pin** –The VISNS signal from the current sense resistor is filtered using RC network created by R4 & C8 in order to provide a clean signal to the IR1155 IC.
- **VCC Pin** – Two 0.47uF ceramic capacitors (located as close as possible to VCC & COM pins) are used to provide optimum decoupling for the VCC bias to IR1155 IC. A 15V zener diode, Z1 is used to clamp overvoltage spikes on VCC pin & protect IR1155 IC.
- **COM Pin** – A STAR connection point located very close to the COM pin of the IC is used to individually terminate all the control signal return loops (VCC, VCOMP, VFB, OVP, BOP & power GND). Please refer to PCB Layout Features section of this document for more information.
- **GATE Pin** – Please refer to Boost Switch & Gate Drive Circuit section of this document for more information.

Hardware Installation & Operating Procedure

The recommended test set-up for IRAC1155-300W is shown in Figure 1.

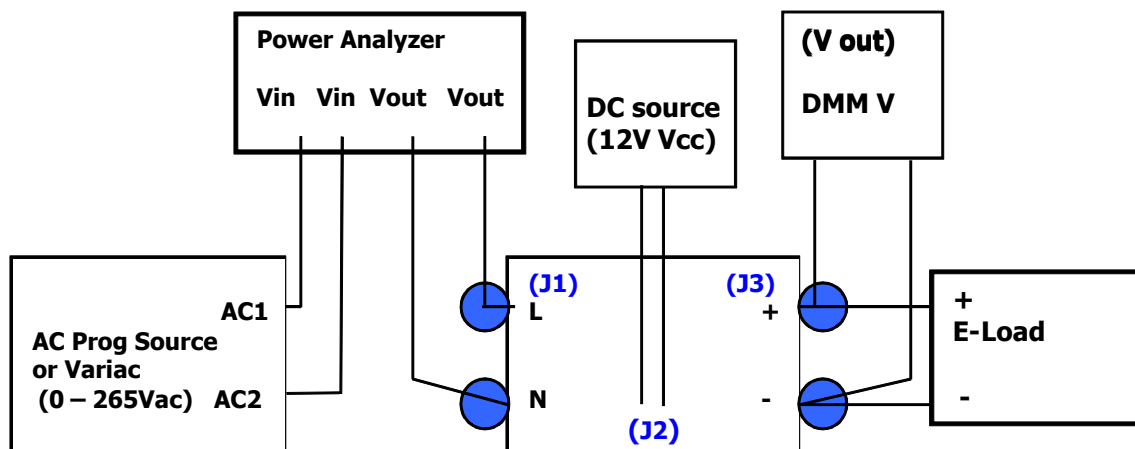

Figure 1 IRAC1155-300W test set-up

Load Connection

Connect high voltage resistive or electronic load, capable of 300W continuous power to connector J3 as shown in Figure 1. Pay attention to the polarity of the terminals in the connector. There is no minimum load requirement for operating IRAC1155-300W. The DC bus voltage is monitored at test-points VOUT and VO_RTN. Always monitor the DC bus voltage to ensure that the capacitor voltage is discharged completely prior to adding or removing load connections from the demo board.

AC Input Connection

Connect a 60Hz AC power source, capable of operation up to 264VAC to connector J1 as shown in Figure 1. The AC input voltage can be monitored at test points L and N. Once power is applied to demo board, potentially lethal high voltages will be present on board and necessary precautions should be taken to avoid serious injury. The use of an isolation transformer on the AC side is highly recommended, so that all the control signals on the test points can easily be probed by using regular oscilloscope probes. Though floating the ground potential of the scope is often practiced, it is not recommended. Failure to follow these guidelines so may result in personal injury or death.

DC supply Connection

Connect a 12V~15V DC power supply to connector J2. This will provide the bias voltage to IR1155.

Power-up

Once all the connections are made the system can be powered up. There is no minimum load requirement during power-up and the system can be powered-up at any load from 0W to 300W. There is no strict biasing sequence for VAC and DC supply. It is OK to supply either voltage first.

Performance Characterization

DC Bus Voltage Regulation

DC bus voltage is regulated to 388V. The output voltage will have some variation from part to part due to device tolerance. The statistic variation is within +/-4%. For a specific board, the output voltage variation over line and load is within +/-0.2%.

Efficiency

The efficiency of IRAC1155-300W demo board is in 94% ~97% at 150W the 50% load over the input line range. The efficiency is tested with NTC thermistor in circuit. If the NTC resistor is shorted, the efficiency can be improved further, especially at low line. A 0.5% efficiency improvement is seen at 85Vac at 50% and 100% load.

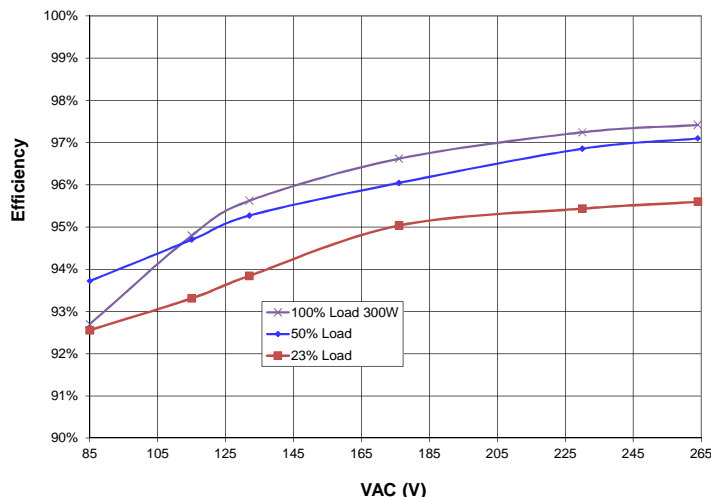

Figure 2 Efficiency over line/load of IRAC1155-300W

Power Factor

IRAC1155-300W delivers power factor greater than 0.99 at 300W, 85-250VAC. At light load condition, there is some drop in power factor which is primarily due to X-capacitors in EMI filter.

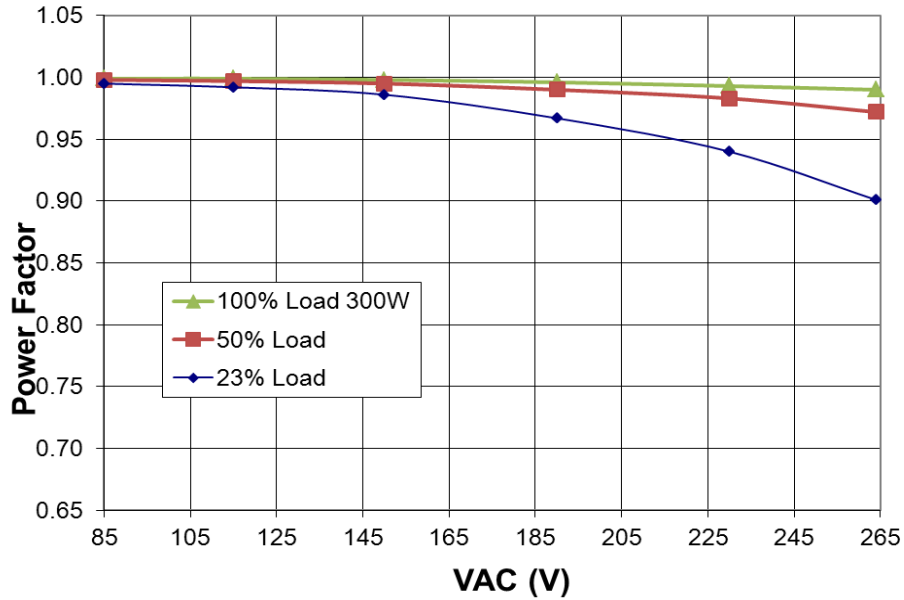

Figure 3. Power factor vs. Line/Load Variation of IRAC1155-300W

Total Harmonic Distortion

IRAC1155-300W delivers less than 10% of Total Harmonic Distortion at the rated 300W output power.

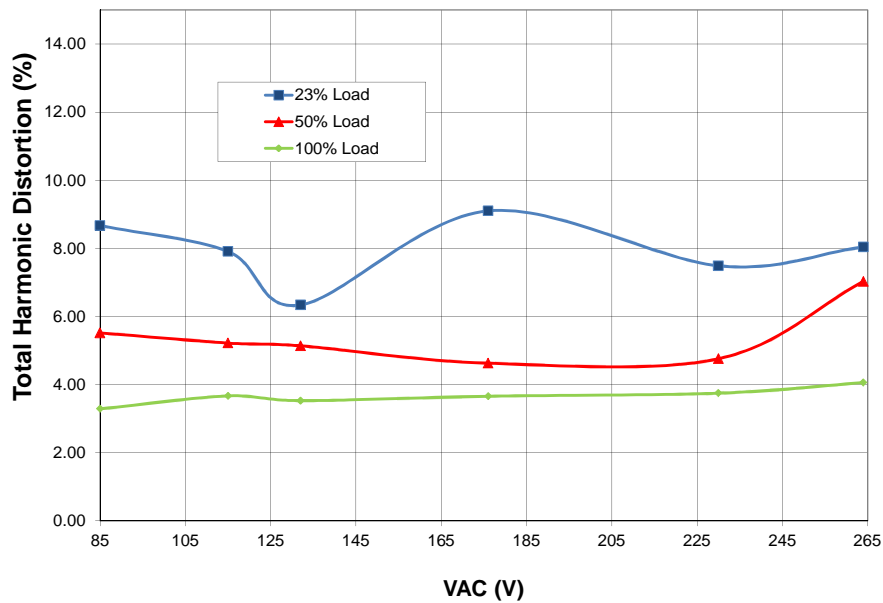
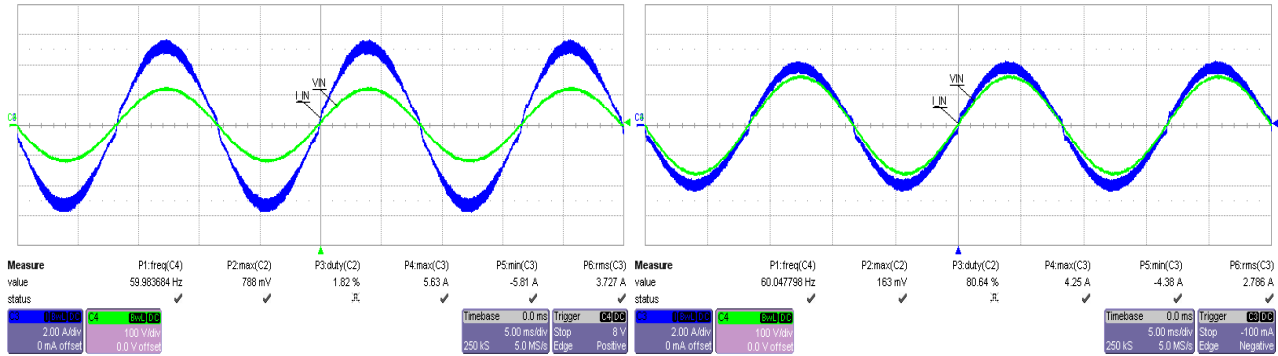

Figure 4. THD across 85-264VAC for IRAC1155-300W

Steady-state Input Current Waveforms (Ch 4: Input Voltage, Ch3: Input Current)



85VAC, 300W

115VAC, 300W

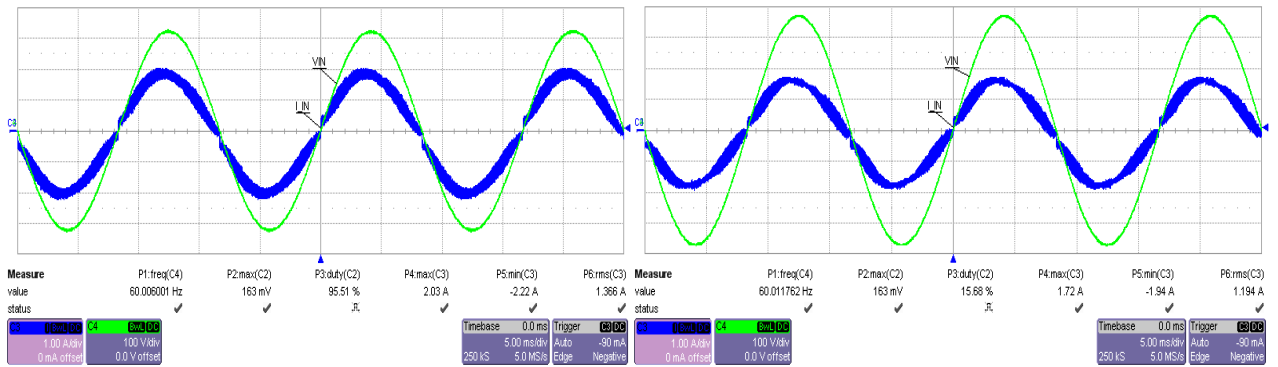

230VAC, 300W

264VAC, 300W

DC Bus Capacitor Ripple Voltage

The sizing of the DC bus capacitor, load condition, AC input voltage frequency etc determine the 2X AC frequency ripple in the DC bus capacitor. The DC bus capacitor ripple in IRAC1155-300W at 300W is less than 10V as seen in Figure 5 and 6.

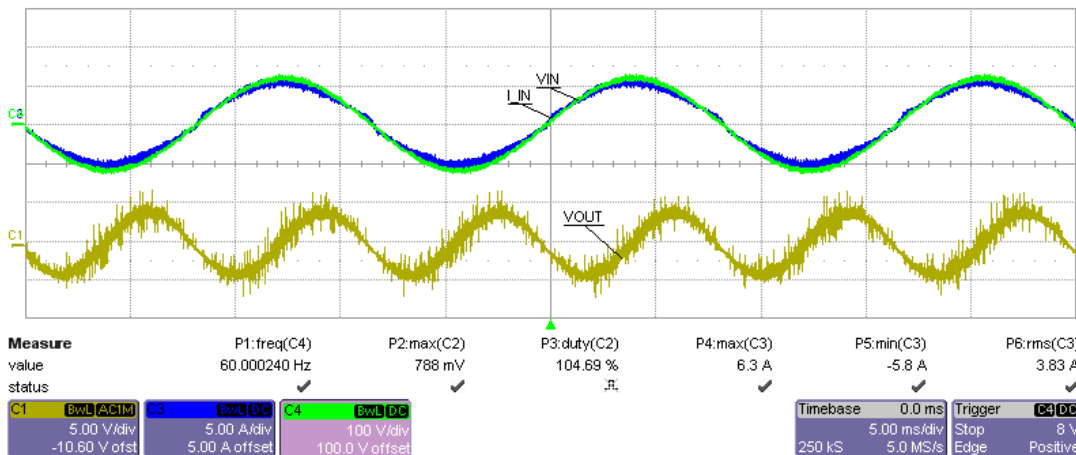

Figure 5. 2X AC frequency ripple in DC bus capacitor at 85VAC, 300W

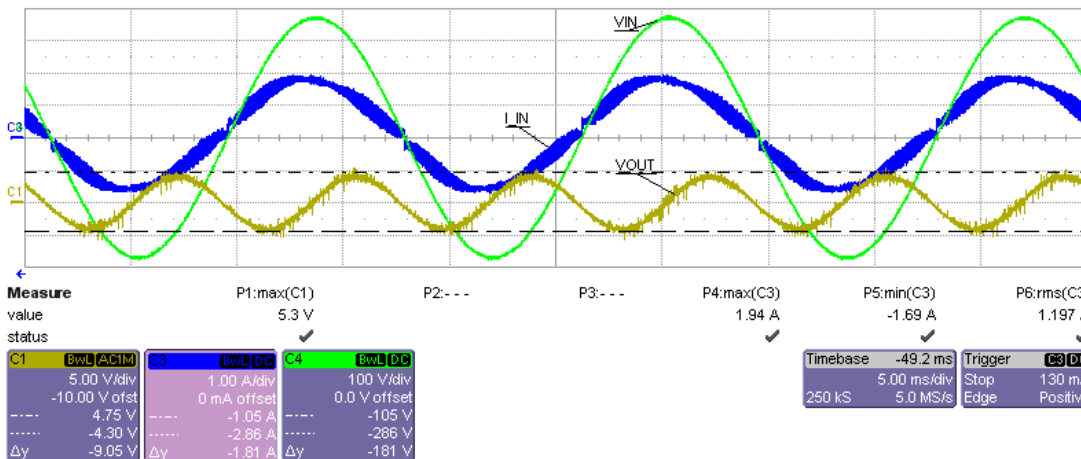
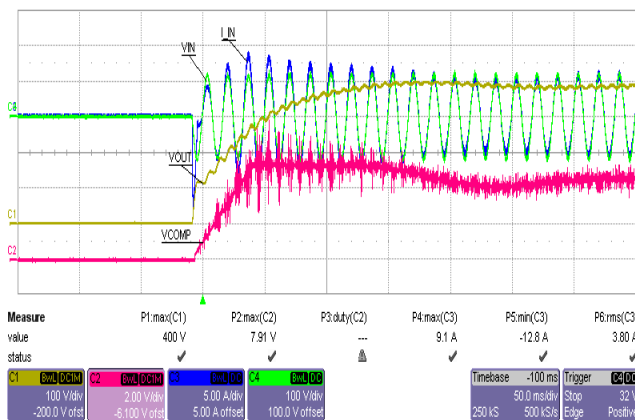

Figure 6. 2X AC frequency ripple in DC bus capacitor at 264VAC, 300W

Start-up Current Waveforms at 100% load

The maximum time for system start-up, about 50msec, is encountered when IRAC1155-300W is powered up at minimum input voltage (85VAC) and maximum output power (300W). The soft-start feature of the IC allows for a linear ramp in the VCOMP voltage, which allows a smooth build-up of AC input RMS current admitted into the PFC converter and DC bus capacitor voltage. Since the PFC voltage loop is a slow loop, the converter goes through a period where the DC bus voltage is under hysteretic OVP condition (between 102.2% and 106.5% of regulation voltage set-point) before the VCOMP voltage stabilizes near the steady stage voltage value.



85VAC, 300W

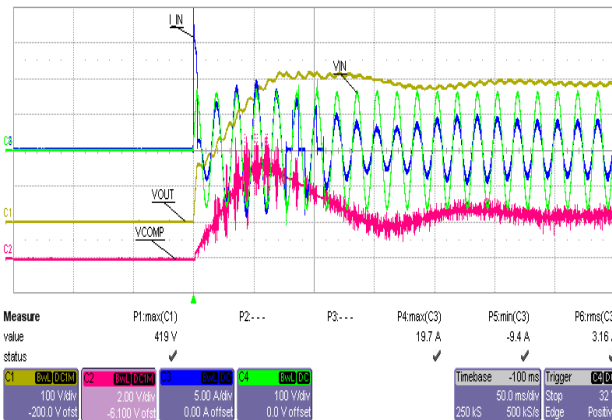

115VAC, 300W

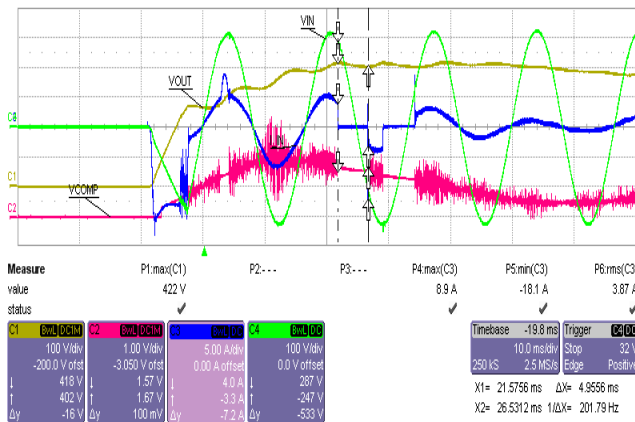

230VAC, 300W

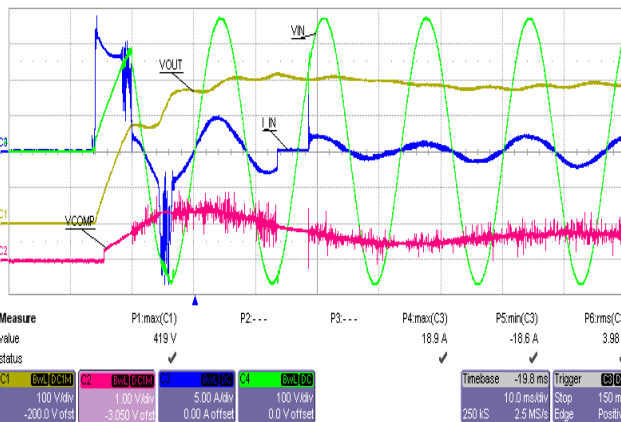

264VAC, 300W

No Load Start-up Current Waveforms

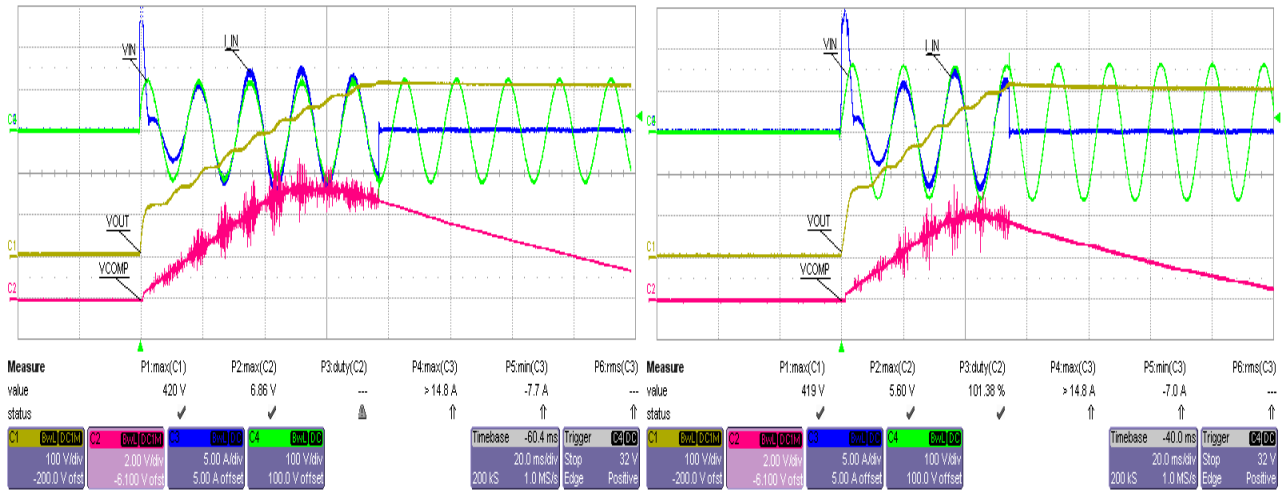

85VAC, 0W

115VAC, 0W

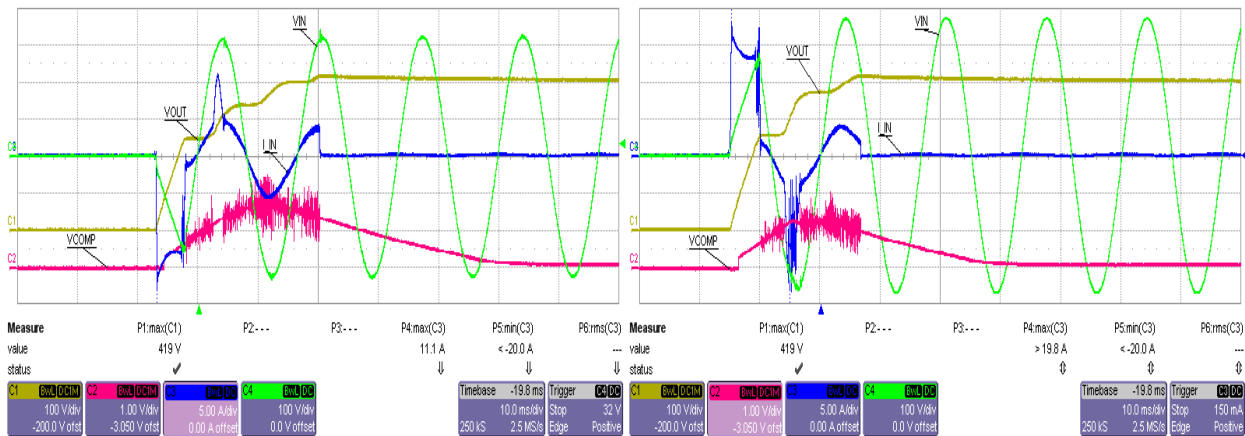

230VAC, 0W

264VAC, 0W

Load Step Waveforms

- No-Load to Full-Load

Under a 0W to 300W load step at 115VAC, the maximum DC bus voltage undershoot is about 50V; the undershoot at 230Vac is 24V.

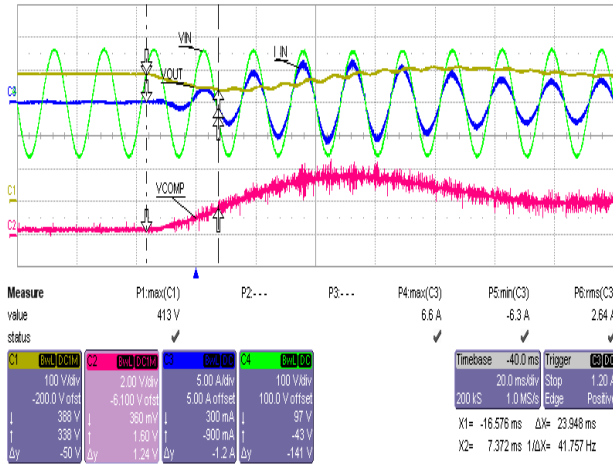

115VAC, 0W to 300W load step

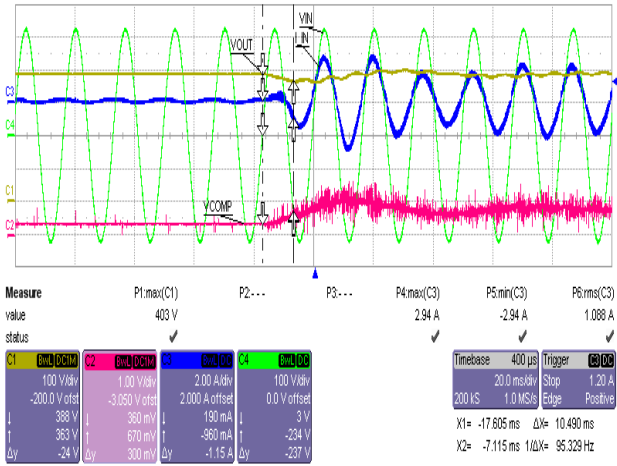

230VAC, 0W to 300W load step

- Full-load to No-Load

300W to 0W negative load step waveforms are presented below. At low line, the OVP protection feature is encountered. IR1155 immediately stops switching when output voltage reaches 419V the OVP threshold. IR1155 resumes boost operation when the DC bus capacitor voltage discharges back to the regulation voltage. At high line, the OVP is not triggered. As COMP pin voltage dropped to a very low level when the load is removed (below Vcomp_start), the gate stops switching and prevents further increasing of Bus voltage.

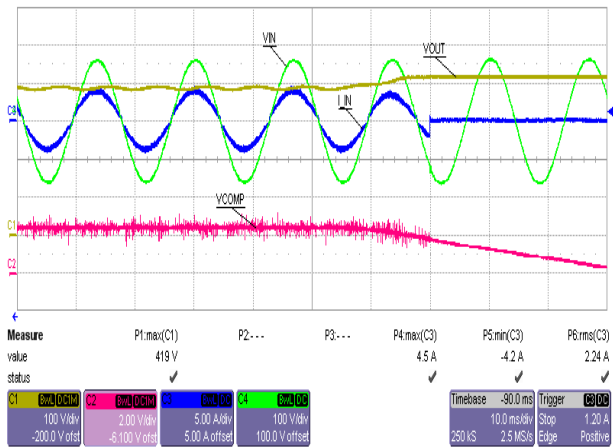

115VAC, 300W to 0W load step

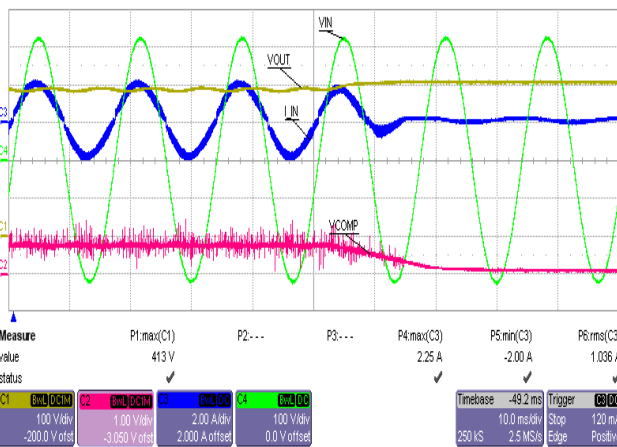

230VAC, 300W to 0W load step

IRAC1155-300W Schematics

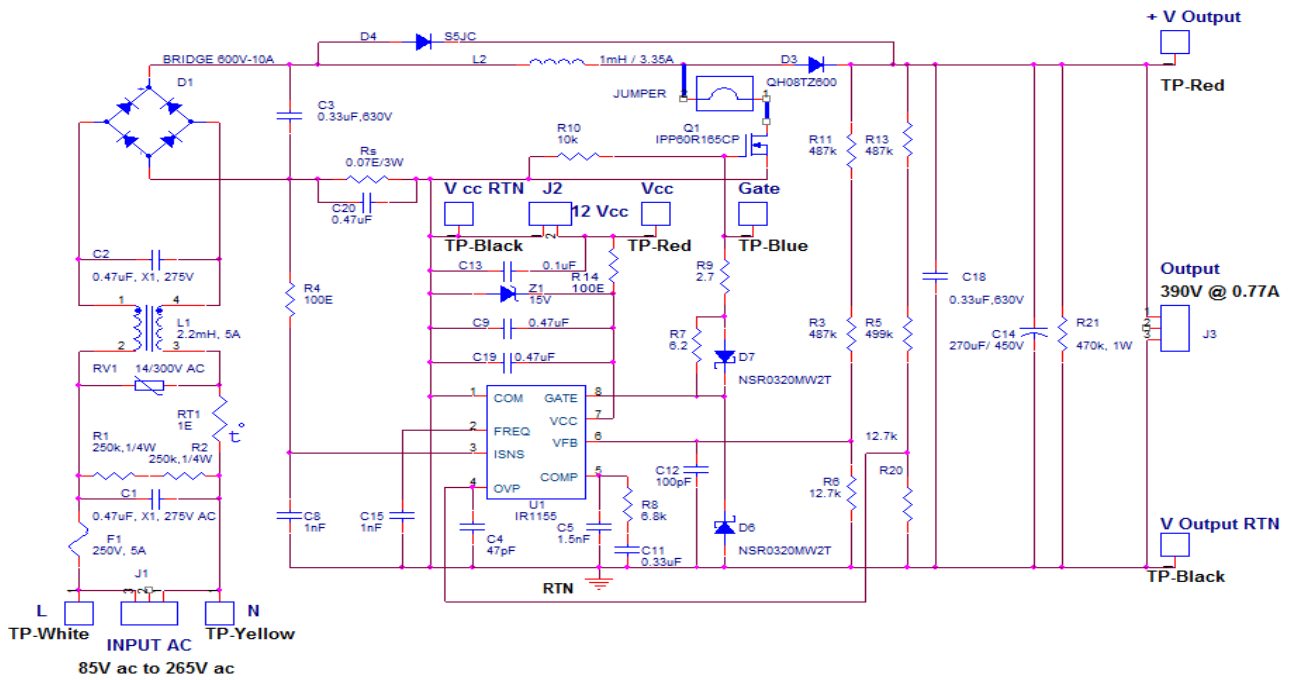

IRAC1155-300W Bill of Materials (BoM)

Sl.No	Designator	Qty	Description	Value	Footprint	Manufacturer	Manufacturer Part Number
1	C1,C2	2	X cap input	0.47 uF, X1, 275 VAC	Radial 8.5 mm W x 25.5 mm L x 17.5 mm H	Panasonic -ECG / Epcos	ECQ-U2A474ML / B32024A3474M
2	C3,C18	2	Polyester Film Capacitors	0.33 uF, 630 VDC METAL POLY	Radial 7.8 mm W x 26 mm L x 17 mm H	Cornell Dubilier / Panasonic -ECG	DME6P33K-F / ECQ-E6334KF
3	C5	1	Ceramic MLCC X7R	1.5 nF, 50V, 10%	0805	AVX	08055C152KAT2A
4	C4	1	Ceramic MLCC NPO	47 pF, 50V, 10%	0805	AVX	08055A470KAT2A
5	C11	1	Ceramic MLCC X7R	0.33 uF,50V, 10%	1206	AVX	12065C334KAT2A
6	C9,C19,C20	3	Ceramic MLCC X7R	0.47 uF,50V, 10%	1206	AVX	12065C474KAT2A
7	C14	1	Bulk Cap	270 uF, 450V, 105 deg.	35x30	Panasonic	EET-HC2W271EA
9	C8, C15	2	Ceramic MLCC X7R	1000 pF, 50V, 10%	0805	AVX	08055C102KAT2A
10	C13	1	Ceramic MLCC X7R	0.1 uF, 50V, 10%	0805	AVX	08055C104JAT2A
11	C12	1	Ceramic MLCC X7R	100 pF, 50V, 10%	0805	AVX	08055C101KAT2A
12	D1	1	Bridge Rectifiers	600 V, 10A	Through Hole, KBU, L- 22.3 mm,W- 18mm,H-18.8mm	Taiwan Semi	KBU1005
13	D3	1	Rectifiers H-Series 600V 8A Super-Low Qrr	600 V, 8 A (QH08TZ600)	TO-220 AC	Power Integrations	QH08TZ600
14	D5	1	Standard Diode Rectifiers	600 V, 5 A (S5JC-13-F)	SMC	Diodes Inc.	S5JC-13-F
15	D6, D7	2	Schottky Diode	20 V, 1 A	SOD-323	ON Semiconductor	NSR0320MW2T3G
16	F1	1	Fuse Holder		PCB-Mounting Vertical type	Elcom	PBF-2M
17	F1	1	Fuses	250VAC, 5A, Fast Acting	5.20mm x 20.00mm	Little Fuse	0217005.H
18	J1,J3	2	Connector	3-Pin Header Vertical	Through Hole	Molex	26-60-4030
19	J2,	1	Connector	2-Pin Header Vertical	Through Hole	Molex	22-23-2021
20	Vcc RTN, Vo RTN	2	TEST POINT Black	TEST POINT PC COMPACT .063"D BLK	Through Hole	Keystone Electronics/Kobiconn	5006k /151-103-RC
21	N	1	TEST POINT Yellow	TEST POINT PC COMPACT .063"D YLW	Through Hole	Keystone Electronics/Kobiconn	5009k/151-102-RC
22	GATE	1	TEST POINT Blue	TEST POINT PC COMPACT .063"D blue	Through Hole	Keystone Electronics/Kobiconn	5122k/151-105-RC
23	L	1	TEST POINT White	TEST POINT PC COMPACT .063"D WHT	Through Hole	Keystone Electronics/Kobiconn	5007k/151-101-RC
24	VCC, VOut	2	TEST POINT Red	TEST POINT PC COMPACT .063"D RED	Through Hole	Keystone Electronics/Kobiconn	5005k/151-107-RC
25	L2	1	Boost inductor	1mH / 3.35A	Custom	Prismatic	9404189501
26	Q1	1	MOSFET	N-CH 600V	TO-220	Infineon	IPP60R165CP
27	RT1	1	Thermistors - NTC	1R, 9A	Radial 15 mm Dia. x 7 mm W x 22 mm H	EPCOS	B57237S0109M000
28	RV1	1	Varistors - MOV	14mm/ 300V AC	Radial	EPCOS	B72214S2301K101
29	Rs	1	Sense resistor 0.07E	0.070, 3 W	Through Hole	IRC	LOB3R070JLF
30	R1,R2	2	SMD- Resistor	249k, 1/4 W, 1%	1206	Yageo (VA)	RC1206FR-07249KL
31	R3,R11,R13	3	SMD- Resistor	487k, 1/8W, 1%	0805	Yageo (VA)	RC0805FR-07487KL
32	R5	2	SMD- Resistor	499k,1/8W, 1%	0805	Yageo (VA)	RC0805FR-07499KL
33	R4	1	SMD- Resistor	100E, 1/4W, 1%	1206	Yageo (VA)	RC1206FR-07100RL
34	R6, R20	2	SMD- Resistor	12.7k,1/8W, 1%	0805	Yageo (VA)	RC0805FR-0712K7L
35	R7	1	SMD- Resistor	6.2E,1/8W, 1%	0805	Yageo (VA)	RC0805FR-076R2L
36	R10	1	SMD- Resistor	10k,1/8W, 1%	0805	Yageo (VA)	RC0805FR-0710KL
37	R8	1	SMD- Resistor	6.8k, 1/8W, 1%	0805	Yageo (VA)	RC0805FR-076K8L
38	R9	1	SMD- Resistor	2.7E,1/8W, 1%	0805	Yageo (VA)	RC0805FR-072R7L
39	R14	1	SMD- Resistor	100,1/8W, 1%	0805	Yageo (VA)	RC0805FR-07100RL
40	R21	1	CFR Resistor	470k, 1W	Through Hole	BC/ Vishay	PR01000104703JR500
41	L1	1	EMI Common Mode Choke	2.2 mH, 5 A	Through Hole Custom	PRECISION	019-4119-00
42	U1	1	Control IC	IR1155	SO-8	IR	IR1155
43	Z1	1	Zener Diodes	15V, 500mW	SMD SOD-123	ON Semiconductor	MMSZ5245BT1G
44	HS 1	1	Heat sink	LSI 182RD 40mm	Custom	LSI	
45	HS 2	1	Heat sink	LSI 182RD 90mm	Custom	LSI	
46	Jumper	1	Wire PVC	1 Sq mm (50 mm L)			
47	PCB	1	PCB	IRAC1155 demo board, Rev-A			
48	Heat sink Assly (D1)	1	Screws	M3x15 Philips head (Nickel)			
49	PCB	8	Screws	M3x10 Philips head (Nickel)			
50	Heat sink Assly (D3)	1	Screws	M3x8 Philips head (Nickel)			
51	Heat sink Assly (Q1)	1	Screws	M2.5x15 Philips head (Nickel)			
52	Heat sink Assly	1	Insulating Bush	TO 220 M2.5 Insulating Bush			
53	Heat sink Assly	1	Sil-Pad	TO 220 Sil-Pad insulating			
54	Heat sink Assly	1	Washer	M2.5 Plain washer(Nickel)			
55	Heat sink Assly	4	Spacer	M3x12 Hexagonal Nylon spacer			
56	Heat sink Assly	1	Nut	M2.5 Nut			
57	Heat sink Assly	1	Spring washer	M2.5 (Nickel)			
58	Heat sink Assly	2	Plain washer	M3 (Nickel)			
59	Heat sink Assly	1	Nut	M3 (Nickel)			
60	Heat sink Assly	2	Spring washer	M3 (Nickel)			
61	Heat sink Assly	4	Fiber washer	M3 (Nickel)			

IRAC1155-300W Components Layout

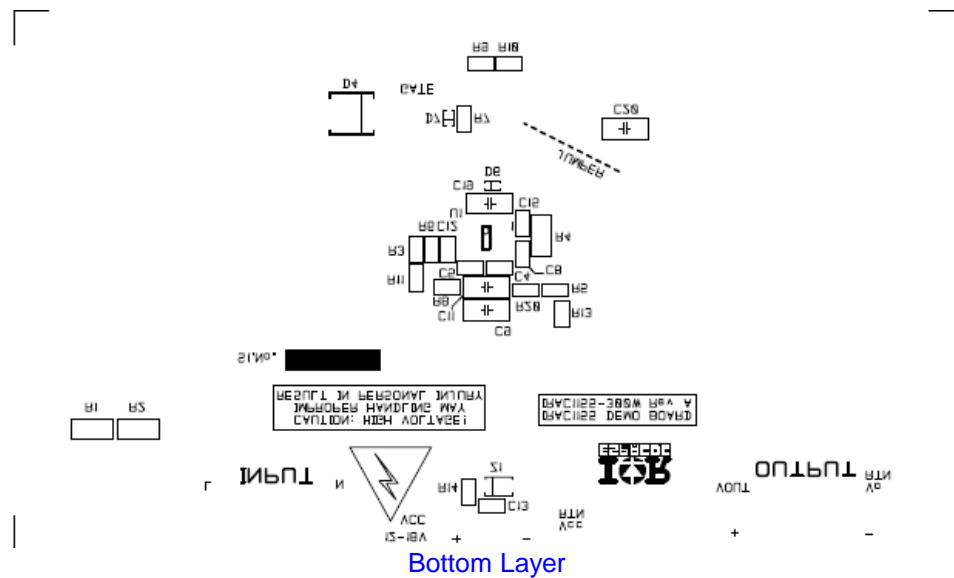
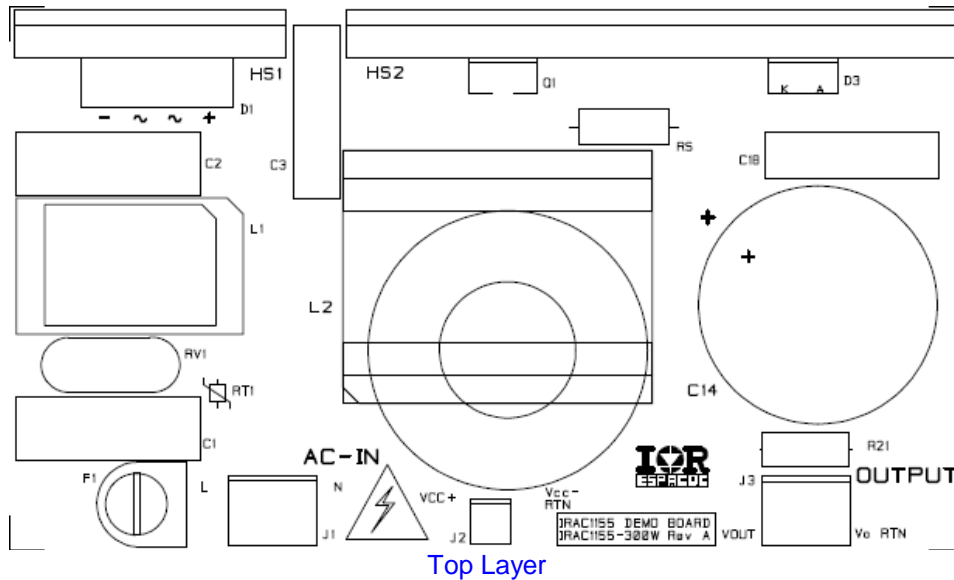

The information provided in this document is believed to be accurate and reliable. However, International Rectifier assumes no responsibility for the consequences of the use of this information. International Rectifier assumes no responsibility for any infringement of patents or of other rights of third parties which may result from the use of this information. No license is granted by implication or otherwise under any patent or patent rights of International Rectifier. The specifications mentioned in this document are subject to change without notice. This document supersedes and replaces all information previously supplied.

For technical support, please contact IR's Technical Assistance Center
<http://www.irf.com/technical-info/>

WORLD HEADQUARTERS:
 233 Kansas St., El Segundo, California 90245
 Tel: (310) 252-7105

Revision History

Date	Comment
4/13/2011	Original document