

WIDEBAND LNA MODULE 2 - 20 GHz



Typical Applications

The HMC-C022 Wideband LNA is ideal for:

- Telecom Infrastructure
- Microwave Radio & VSAT
- Military & Space
- Test Instrumentation
- Fiber Optics

Functional Diagram

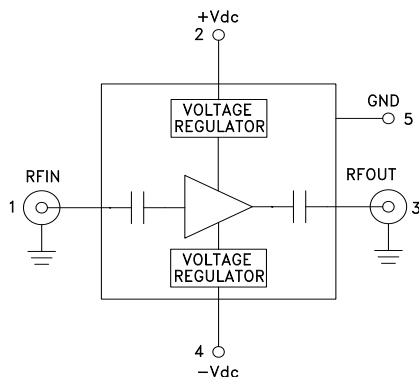

Features

- Noise Figure: 2 dB @ 8 GHz
- Flat Gain: 14 dB \pm 0.5 dB
- P1dB Output Power: +18 dBm @ 8 GHz
- Spurious-Free Operation
- Regulated Supply and Bias Sequencing
- Hermetically Sealed Module
- Field Replaceable SMA connectors
- 55 °C to +85 °C Operating Temperature

General Description

The HMC-C022 is a GaAs MMIC pHEMT Low Noise Distributed Amplifier in a miniature, hermetic module with replaceable SMA connectors which operates between 2 and 20 GHz. The amplifier provides 14 dB of gain, 2 to 3 dB noise figure and up to +18 dBm of output power at 1 dB gain compression. Gain flatness is excellent from 2 - 18 GHz making the HMC-C022 ideal for EW, ECM RADAR and test equipment applications. The wideband amplifier I/Os are internally matched to 50 Ohms and are internally DC blocked. Integrated voltage regulators allow for flexible biasing of both the negative and positive supply pins, while internal bias sequencing circuitry assures robust operation.

Electrical Specifications, $T_A = +25^\circ\text{C}$, +Vdc = +8V to +16V, -Vdc = -3V to -12V

Parameter	Min.	Typ.	Max.	Min.	Typ.	Max.	Min.	Typ.	Max.	Units
Frequency Range	2 - 6			6 - 12			12 - 20			GHz
Gain	12	15		11	14		10	13		dB
Gain Flatness		\pm 0.25			\pm 0.5			\pm 0.5		dB
Gain Variation Over Temperature		0.008	0.015		0.008	0.015		0.008	0.015	dB/ °C
Noise Figure		2.5	4.5		2.0	3.0		3.0	5.0	dB
Input Return Loss		17			17			18		dB
Output Return Loss		13			15			8		dB
Output Power for 1 dB Compression (P1dB)	15	18		13	16		9	13		dBm
Saturated Output Power (Psat)		22			21			19		dBm
Output Third Order Intercept (IP3)		28			27			23		dBm
Positive Supply Current (+IDC)		75			75			75		mA
Negative Supply Current (-IDC)		1.8			1.8			1.8		mA

Information furnished by Analog Devices is believed to be accurate and reliable. However, no responsibility is assumed by Analog Devices for its use, nor for any infringements of patents or other rights of third parties that may result from its use. Specifications subject to change without notice. No license is granted by implication or otherwise under any patent or patent rights of Analog Devices. Trademarks and registered trademarks are the property of their respective owners.

For price, delivery, and to place orders: Analog Devices, Inc., One Technology Way, P.O. Box 9106, Norwood, MA 02062-9106
Phone: 781-329-4700 • Order online at www.analog.com
Application Support: Phone: 1-800-ANALOG-D

HMC-C022* PRODUCT PAGE QUICK LINKS

Last Content Update: 02/23/2017

COMPARABLE PARTS

View a parametric search of comparable parts.

DOCUMENTATION

Application Notes

- AN-1363: Meeting Biasing Requirements of Externally Biased RF/Microwave Amplifiers with Active Bias Controllers

Data Sheet

- HMC-C022 Data Sheet

TOOLS AND SIMULATIONS

- HMC-C022 S-Parameter

DESIGN RESOURCES

- HMC-C022 Material Declaration
- PCN-PDN Information
- Quality And Reliability
- Symbols and Footprints

DISCUSSIONS

View all HMC-C022 EngineerZone Discussions.

SAMPLE AND BUY

Visit the product page to see pricing options.

TECHNICAL SUPPORT

Submit a technical question or find your regional support number.

DOCUMENT FEEDBACK

Submit feedback for this data sheet.

**WIDEBAND LNA MODULE
2 - 20 GHz**

Gain & Return Loss

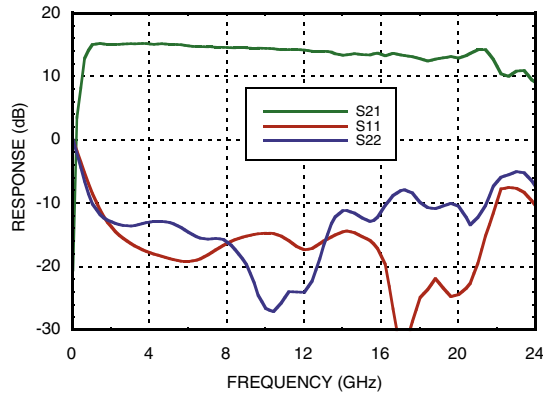

Gain vs. Temperature

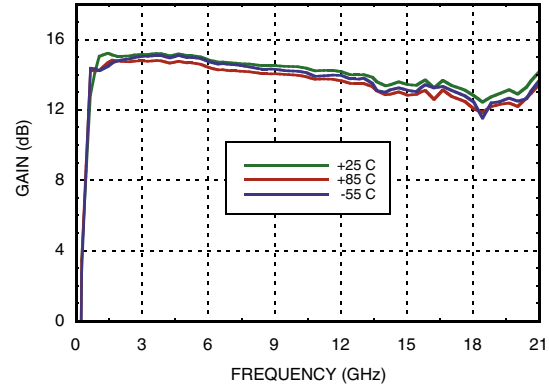

Input Return Loss vs. Temperature

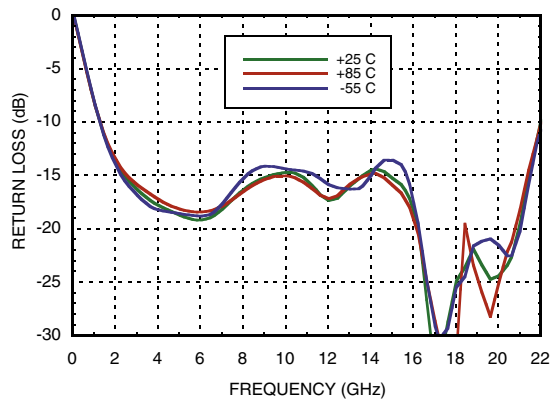

Output Return Loss vs. Temperature

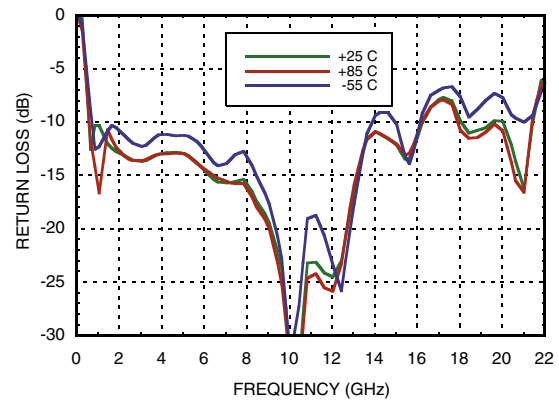

Reverse Isolation vs. Temperature

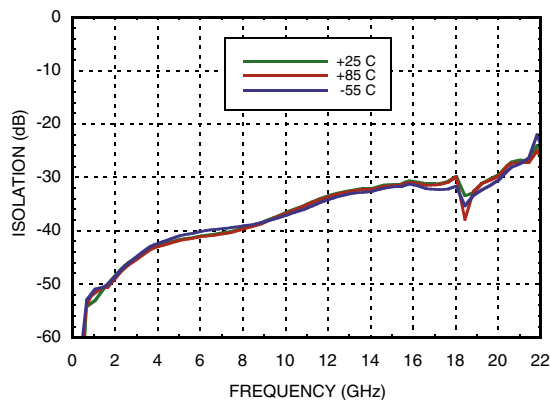

Noise Figure vs. Temperature

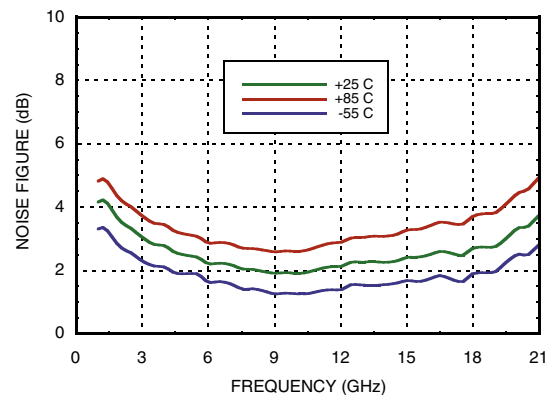

Information furnished by Analog Devices is believed to be accurate and reliable. However, no responsibility is assumed by Analog Devices for its use, nor for any infringements of patents or other rights of third parties that may result from its use. Specifications subject to change without notice. No license is granted by implication or otherwise under any patent or patent rights of Analog Devices. Trademarks and registered trademarks are the property of their respective owners.

For price, delivery, and to place orders: Analog Devices, Inc., One Technology Way, P.O. Box 9106, Norwood, MA 02062-9106 Phone: 781-329-4700 • Order online at www.analog.com Application Support: Phone: 1-800-ANALOG-D

WIDEBAND LNA MODULE 2 - 20 GHz

P1dB vs. Temperature

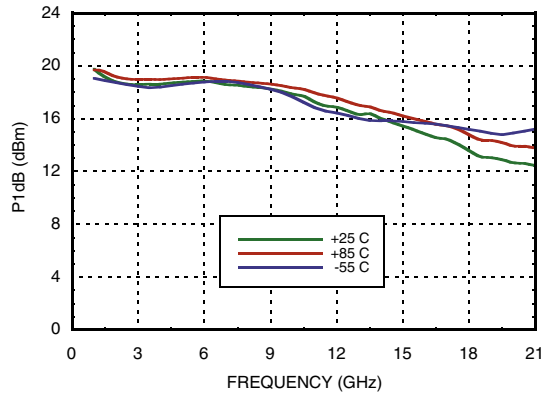

Psat vs. Temperature

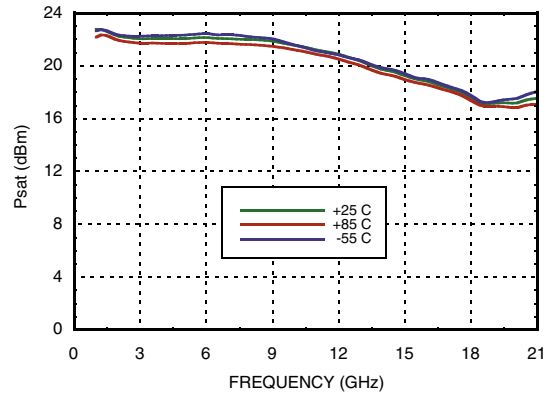

Output IP3 vs. Temperature

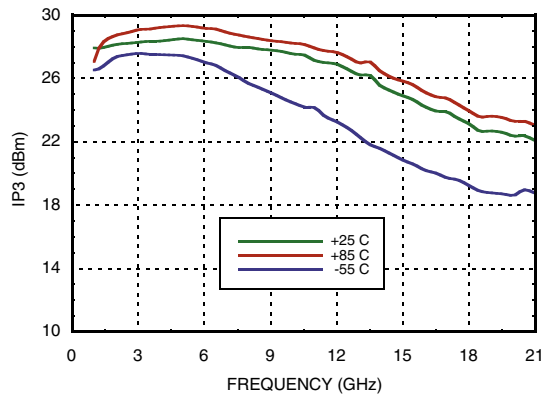

Absolute Maximum Ratings



Positive Bias Supply Voltage (+Vdc)	+17V Max
Negative Bias Supply (-Vdc)	-16V Min.
RF Input Power (RFIN)	+18 dBm
Storage Temperature	-65 to +150 °C
Operating Temperature	-55 to +85 °C



**ELECTROSTATIC SENSITIVE DEVICE
OBSERVE HANDLING PRECAUTIONS**

WIDEBAND LNA MODULE 2 - 20 GHz

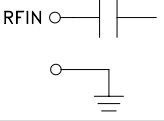
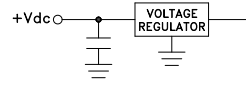
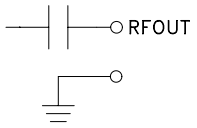
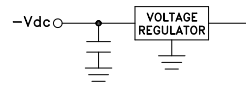
Pin Descriptions

Pin Number	Function	Description	Interface Schematic
1	RFIN & RF Ground	RF input connector, SMA female, field replaceable. This pin is AC coupled and matched to 50 Ohms.	
2	+Vdc	Positive power supply voltage for the amplifier.	
3	RFOUT & RF Ground	RF output connector, SMA female. This pin is AC coupled and matched to 50 Ohms.	
4	-Vdc	Negative power supply voltage for the amplifier.	
5	GND	Power supply ground.	

**WIDEBAND LNA MODULE
2 - 20 GHz**

Outline Drawing

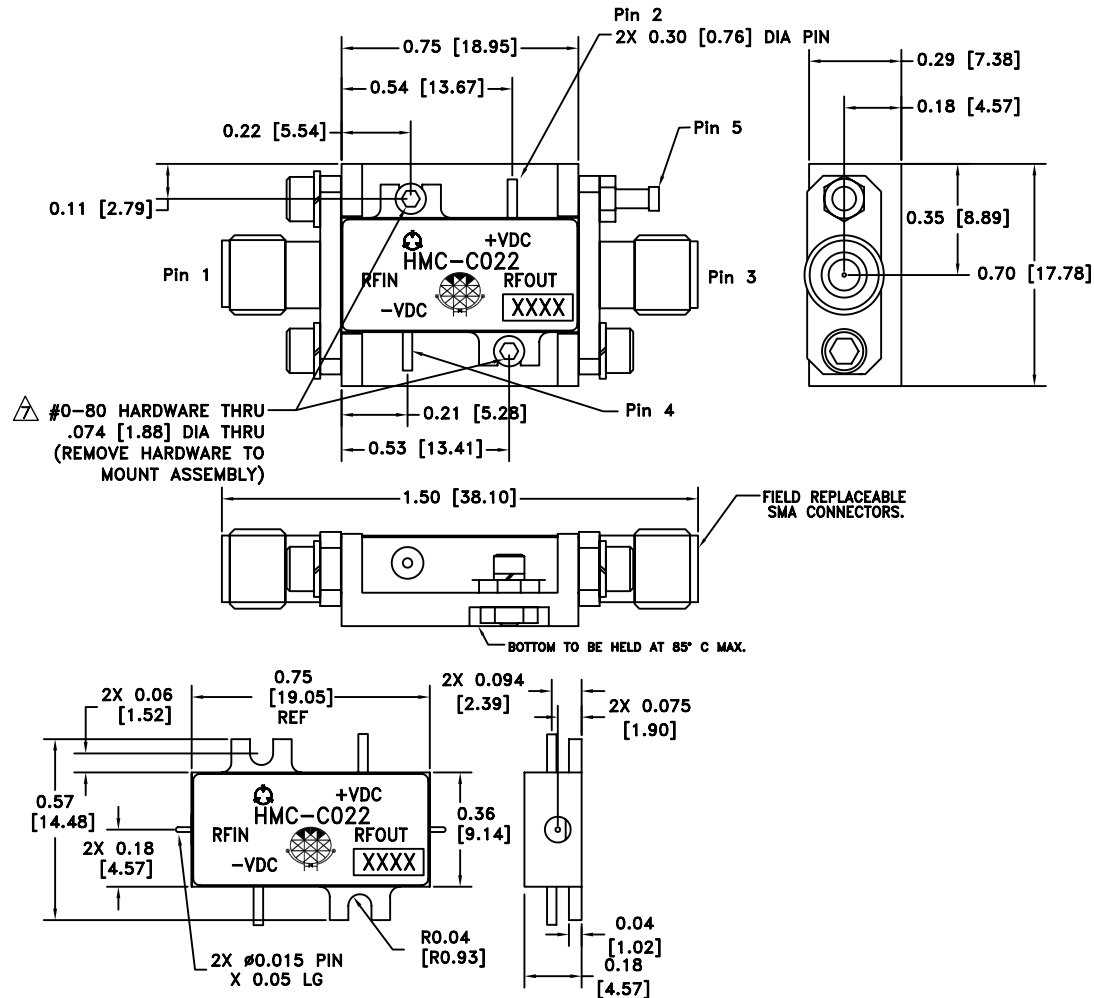

Package Information

Package Type	C-2B
Package Weight ^[1]	11.2 gms ^[2]
Spacer Weight	N/A

[1] Includes the connectors

[2] ±1 gms Tolerance

NOTES:

1. PACKAGE, LEADS, COVER MATERIAL: KOVAR™
2. SPACER MATERIAL: ALUMINUM
3. PLATING: ELECTROLYTIC GOLD 50 MICROINCHES MIN., OVER ELECTROLYTIC NICKEL 75 MICROINCHES MIN.
4. ALL DIMENSIONS ARE IN INCHES [MILLIMETERS].
5. TOLERANCES ±.005 [0.13] UNLESS OTHERWISE SPECIFIED.
6. FIELD REPLACEABLE SMA CONNECTORS. TENSOLITE 5602 - 5CCSF OR EQUIVALENT.

△ TO MOUNT MODULE TO SYSTEM PLATFORM REPLACE 0 - 80 HARDWARE WITH DESIRED MOUNTING SCREWS.

**WIDEBAND LNA MODULE
2 - 20 GHz****Notes:**