

Tous droits strictement reserves. Reproduction ou communication a des tiers interdite sous quelque forme que ce soit sans autorisation écrite du propriétaire. Propriete de c FCI. Droits de reproduction FCI.

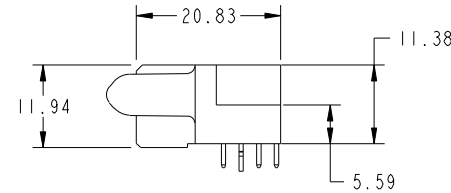

All rights strictly reserved. Reproduction or issue to third parties in any form whatever is not permitted without written authority from the proprietor. Property of FCI. Copyright FCI.

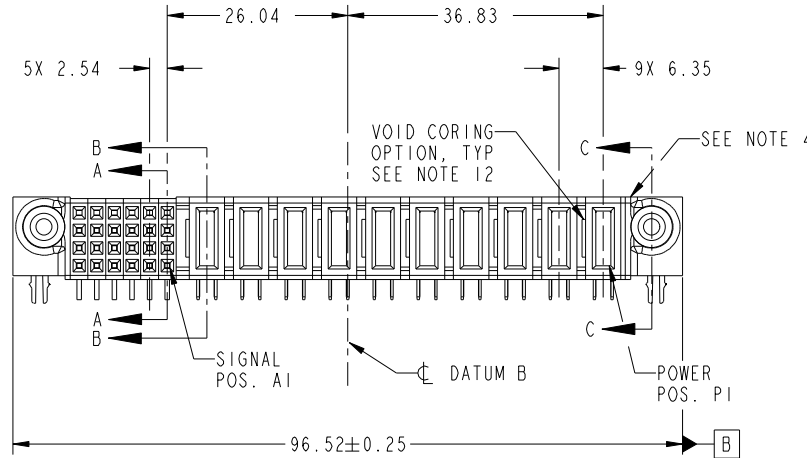
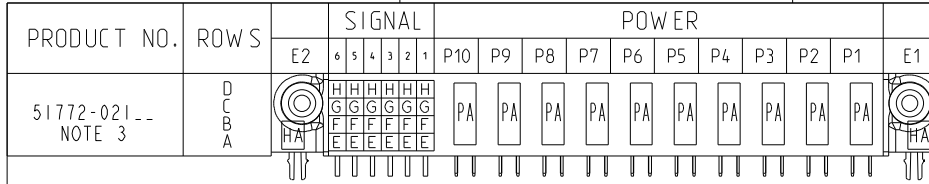

CODE	DIM "M" MATING LENGTH	CONTACT TYPE
PA	[1.07]	POWER
H	[N/A]	SIGNAL
G	[N/A]	SIGNAL
F	[N/A]	SIGNAL
E	[N/A]	SIGNAL
HA	[N/A]	HOLD-DOWN

mat'l code				SEE NOTE 2		tolerances unless otherwise specified		CUSTOMER	
ltr	ecn no.	dr	date	linear	0.X ±0.5	projection	www.fciconnect.com		
A	DG10-0443	XQ	12/12/10	angles	0.XX ±0.25		title 10P + 24S R/A SOLDER RECEPTACLE		
					0.XXX ±0.1		product family PwrBlade	code 213	
				dr	0° ±2°	size	dwg no	sheet	
				enr	XQ Wong 12/01/10	scale 1:1	A	51772-021	1 of 4
				chr	XQ Wong 12/01/10				
				appd	PM ZHENG 12/01/10				
sheet index	revision sheet	A 1	A 2	A 3	A 4	cage code 22526		4	

sheet index		revision sheet		A 1		A 2		A 3		A 4		cage code		4	
Pro/E												22526			

Tous droits strictement reserves. Reproduction ou communication a des tiers interdite sous quelque forme que ce soit sans autorisation écrite du propriétaire. Propriete de c FCI. Droits de reproduction FCI.

All rights strictly reserved. Reproduction or issue to third parties in any form whatever is not permitted without written authority from the proprietor. Property of FCI. Copyright FCI.



PRODUCT NUMBER
51772-021--
NOTE 3

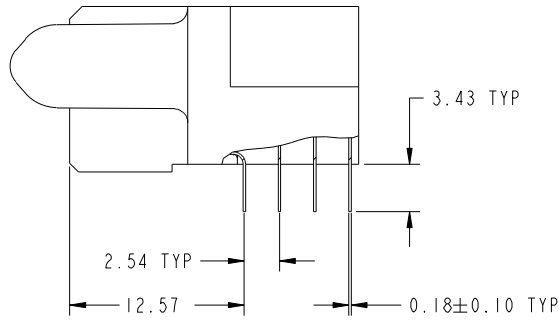

BROKEN-OUT SECTION A-A
SCALE 2:1

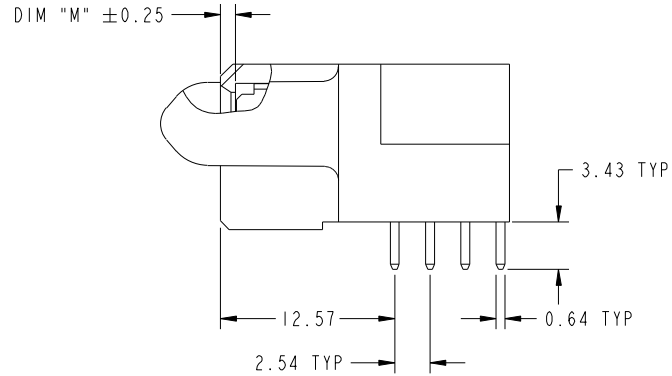

BROKEN-OUT SECTION B-B
SCALE 2:1

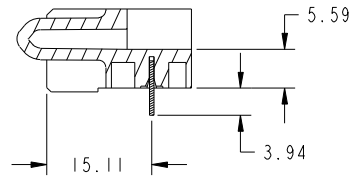

SECTION C-C

mat'l code		SEE NOTE 2		tolerances unless otherwise specified		CUSTOMER		FCI	
ltr	ecr no.	dr	date	linear	0.X ± 0.5	COPY		www.fciconnect.com	
A				linear	0.XX ± 0.25	projection	title		
				angles	0.XXX ± 0.1			10P + 24S R/A SOLDER RECEPTACLE	
				dr	0° ± 2°			product family	PwrBlade
				enr	X0 Wang 12/01/10	scale	size	dwg no	code
				chr	X0 Wang 12/01/10	1:1	A	51772-021	213
				appd	PM ZHENG 12/01/10				sheet
					JOSEPH HSIA 12/01/10				2 of 4
sheet index	revision sheet								

cage code 22526

Pro/E

Tous droits strictement reserves. Reproduction ou communication a des tiers interdite sous quelque forme que ce soit sans autorisation écrite du propriétaire. Propriete de c FCI. Droits de reproduction FCI.



All rights strictly reserved. Reproduction or issue to third parties in any form whatever is not permitted without written authority from the proprietor. Property of FCI. Copyright FCI.

PRODUCT NUMBER
51772-021--
NOTE 3

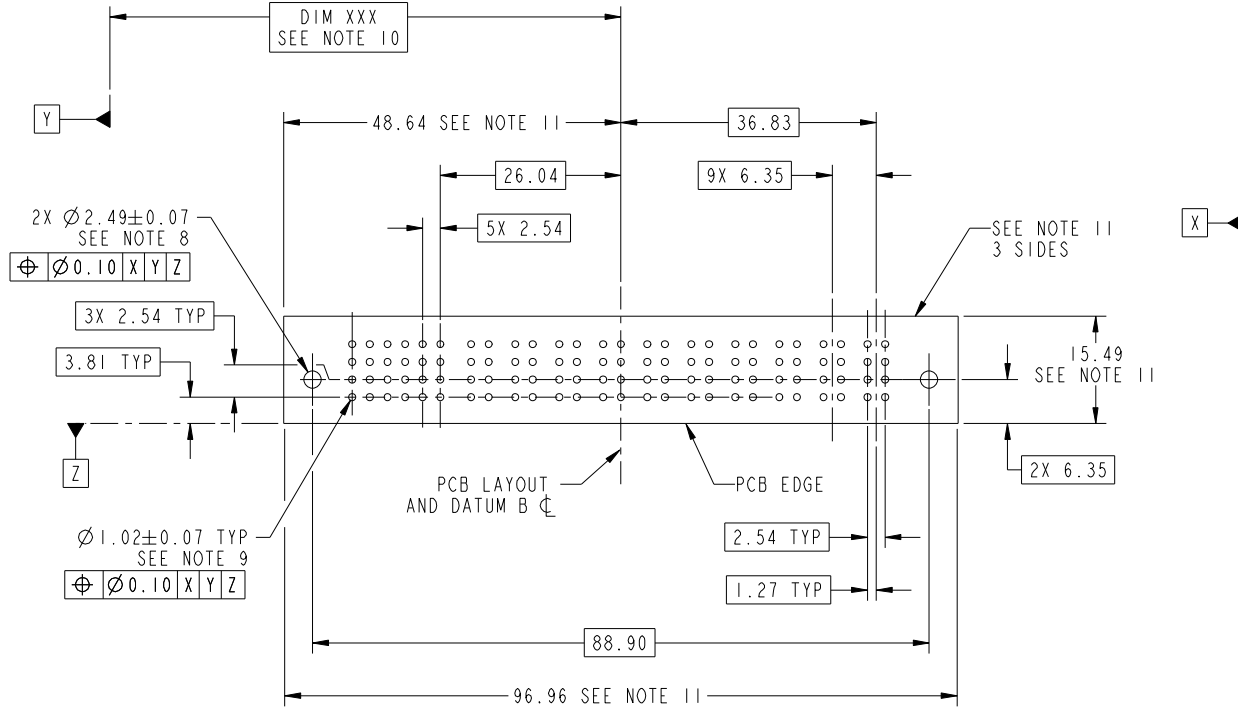

RECOMMENDED PCB LAYOUT

mat'l code		SEE NOTE		tolerances unless otherwise specified		CUSTOMER		FCI	
ltr	ecn no.	dr	date	linear	0.X ±0.5	COPY		www.fciconnect.com	
A					0.XX ±0.25	projection		title	
				angles	0.XXX ±0.1			10P + 24S R/A SOLDER RECEPTACLE	
				dr	0° ±2°			product family PwrBlade code	
				enr	X0 Wang 12/01/10	scale		size	
				chr	X0 Wang 12/01/10	1:1		dwg no	
				appd	PM ZHENG 12/01/10	A		51772-021	
					JOSEPH HSIA 12/01/10			sheet	
sheet index	revision sheet							3 of 4	

cage code 22526

Pro/E

Tous droits strictement reserves. Reproduction ou communication a des tiers interdite sous quelque forme que ce soit sans autorisation écrite du propriétaire. Propriete de c FCI. Droits de reproduction FCI.



All rights strictly reserved. Reproduction or issue to third parties in any form whatever is not permitted without written authority from the proprietor. Property of FCI. Copyright FCI.

PRODUCT NUMBER
51772-021--
NOTE 3

NOTES:

1. DIMENSIONS AND TOLERANCES ARE IN ACCORDANCE WITH ASME Y14.5M, 1994 UNLESS OTHERWISE SPECIFIED.

CONNECTOR NOTES:

- 2. HOUSING MATERIAL: UL 94 V-0 GLASS FILLED HIGH-TEMP THERMOPLASTIC
POWER CONTACT MATERIAL: COPPER ALLOY
SIGNAL PIN MATERIAL: COPPER ALLOY
- 3. SEE ITEM 5 & 6 IN PRINT 10064183 FOR PLATING SPEC OF 51772-021 AND 51772-021LF RESPECTIVELY.
- 4. MANUFACTURER'S NAME, DATE CODE AND OPTIONAL P/N TO APPEAR ON THIS SURFACE. THE P/N CAN BE OMITTED IF THERE IS NOT ENOUGH SPACE ON THIS SURFACE.
- 5. PRODUCT SPECIFICATION GS-12-149.
APPLICATION SPECIFICATION BUS-20-067.
- 6. PACKAGED IN TRAYS.

PCB NOTES:

- 7. ALL HOLE DIAMETERS ARE FINISHED HOLE SIZE.
- 8. MOUNTING HOLES, WHERE APPLICABLE, ARE UNPLATED.
- 9. $\varnothing 1.151 \pm 0.025$ DRILLED HOLES PLATED WITH 0.008 MIN SnPb OR Sn OVER 0.03 TO 0.08 Cu PLATING TO ACHIEVE $\varnothing 1.02 \pm .07$ HOLE.
- 10. "DIM XXX" TO BE DETERMINED BY THE CUSTOMER.
- 11. CONNECTOR KEEP-OUT ZONE.
- 12. THE VOID CORING IN BETWEEN POWER MODULES, SIGNAL MODULES AND END MODULES ARE OPTIONAL AND THE SHAPE MAY BE DIFFERENT FOR OPTIMIZE THE MOLDING PROCESS. THE VOID CORING WILL NOT EFFECT TO PRODUCT FUNCTION.

mat'l code		SEE NOTE 2		tolerances unless otherwise specified		CUSTOMER		FCI	
ltr	ecr no.	dr	date	linear	0.X ± 0.5	COPY		www.fciconnect.com	
A					0.XX ± 0.25	projection		title	
				angles	0.XXX ± 0.1			10P + 24S R/A SOLDER RECEPTACLE	
				dr	0° ± 2°			product family PwrBlade code	
				enrg	X0 Wang 12/01/10	scale		size	
				chr	X0 Wang 12/01/10	1:1		dwg no	
				appd	PM ZHENG 12/01/10	A		51772-021	
					JOSEPH HSIA 12/01/10			sheet	
sheet index	revision sheet							4 of 4	

cage code 22526

Pro/E