

SF1184B-1

947.5 MHz SAW Filter

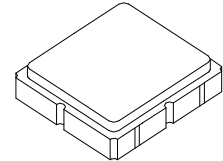

SM3030-6

- **RF Filter for GSM900**
- **No Matching Circuit Required**
- **3.0 x 3.0 x 1.3 mm Package**
- **Complies with Directive 2002/95/EC (RoHS)**



Absolute Maximum Ratings

Rating	Value	Units
Maximum Input Power	+15	dBm
DC voltage between Terminals	-5 ~ +5	VDC
Operating Temperature	-30 to +85	°C

Electrical Characteristics

Characteristic	Sym	Notes	Min	Typ	Max	Units
Nominal Operating Frequency	f_c			947.5		MHz
Passband	Insertion Loss (935~960 MHz)			2.7	3.5	dB
		Amplitude Ripple (935~960 MHz)		0.6	1.4	dB
Attenuation	D.C.~871 MHz		50	62.1		dB
			30	43.9		dB
			25	28.6		dB
			45	54.1		dB
			20	26.8		dB
VSWR (935~960 MHz)				1.6	2.3	dB
Impedance at f_c ; Input Z_{IN}		1		50		Ω
Output Z_{OUT}		1		50		Ω

Case Style	SM3030-6 3 x 3 mm Nominal Footprint
Lid Symbolization (YY=year, WW=week, D=day)	459 YYWWD

Electrical Connections

Connection	Terminals
Input	2
Output	5
Ground	All others



CAUTION: Electrostatic Sensitive Device. Observe precautions for handling.

NOTES:

1. Unless noted otherwise, all specifications apply over the operating temperature range with filter soldered to the specified demonstration board with impedance matching to 50 Ω and measured with 50 Ω network analyzer.
2. Unless noted otherwise, all frequency specifications are referenced to the nominal center frequency, f_c .
3. Rejection is measured as attenuation below the minimum IL point in the passband. Rejection in final user application is dependent on PCB layout and external impedance matching design. See Application Note No. 42 for details.
4. "LRIP" or "L" after the part number indicates "low rate initial production" and "ENG" or "E" indicates "engineering prototypes."
5. The design, manufacturing process, and specifications of this filter are subject to change.
6. Either Port 1 or Port 2 may be used for either input or output in the design. However, impedances and impedance matching may vary between Port 1 and Port 2, so that the filter must always be installed in one direction per the circuit design.
7. US and international patents may apply.
8. Murata, stylized Murata logo, and Murata N.A., Inc. are registered trademarks of Murata Manufacturing Co., Ltd.

FREQUENCY CHARACTERISTICS:

1. wideband response:

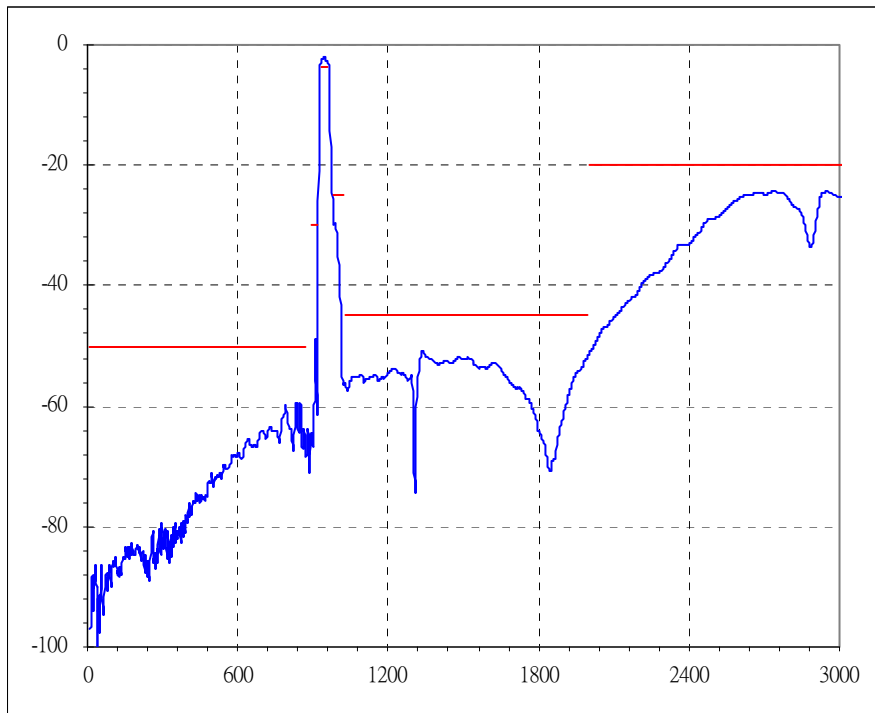
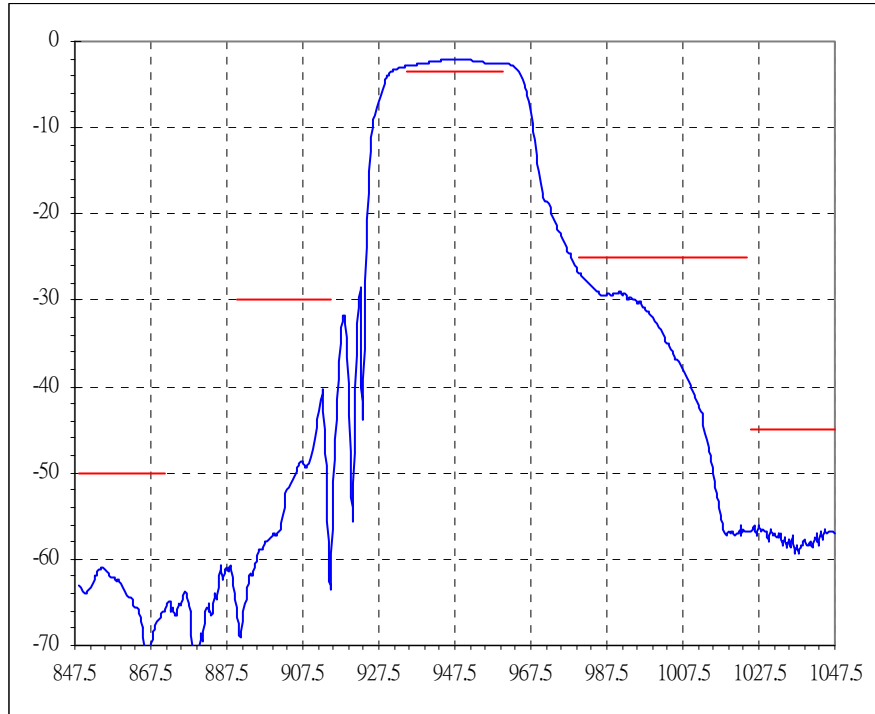

1. passband response:

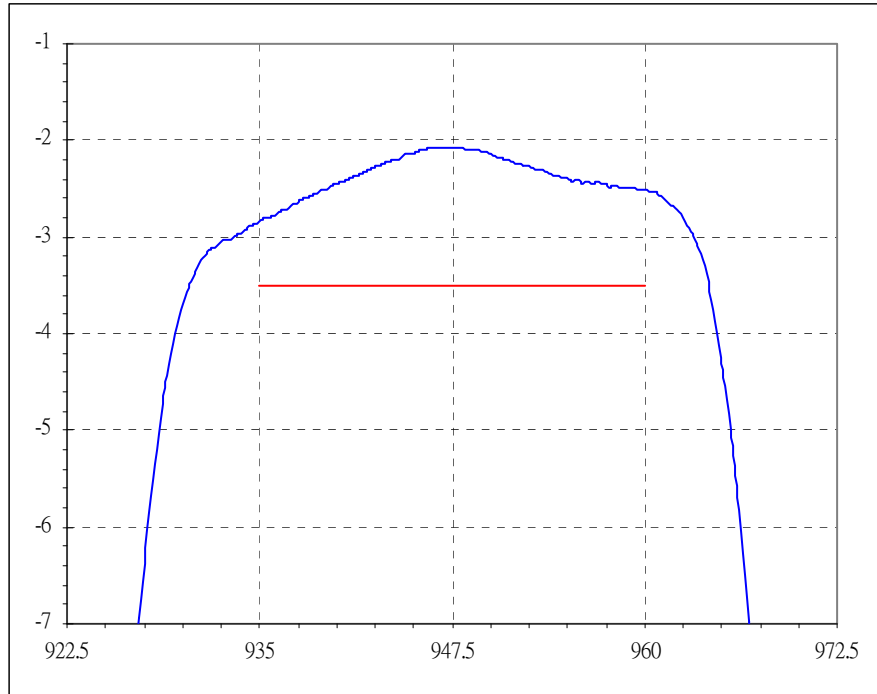

2. VSRW:

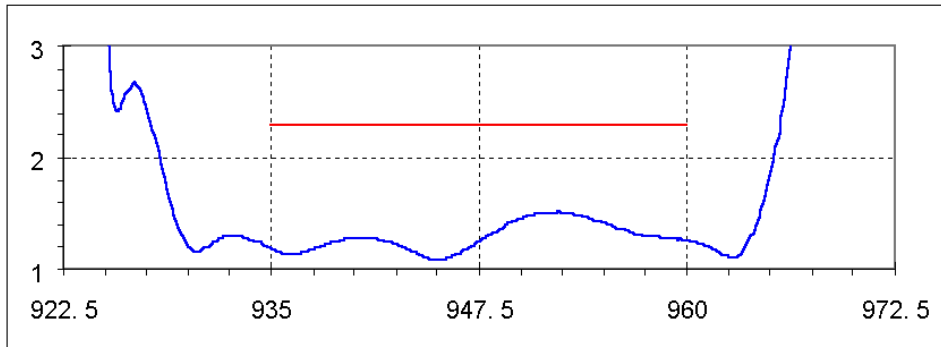

S22

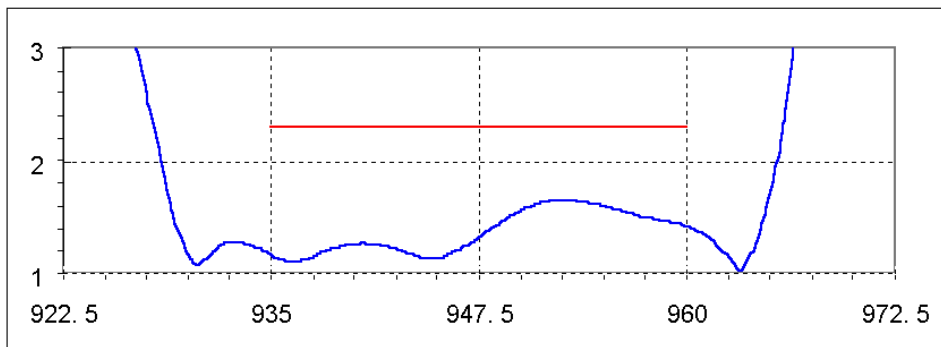

3. Smith chart of S11:

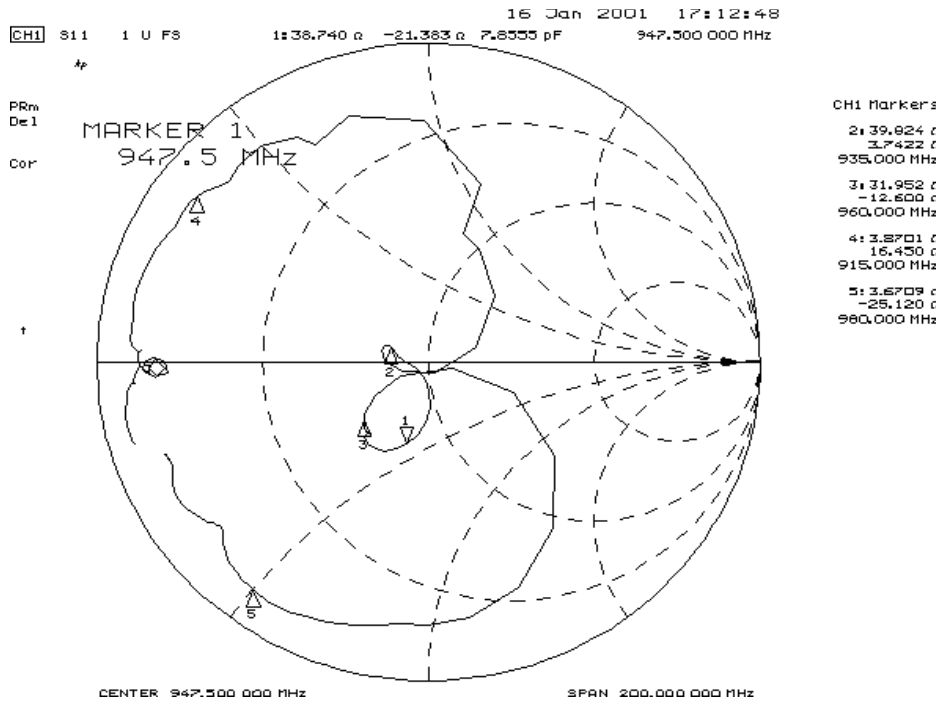

4. Smith chart of S22:

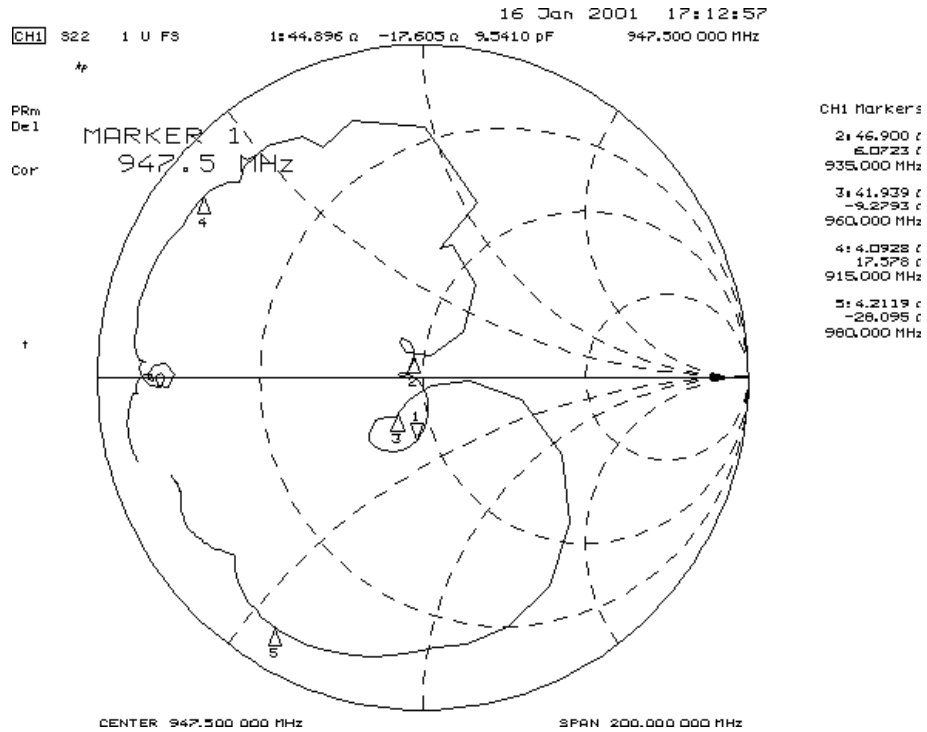

Tape and Reel Specifications

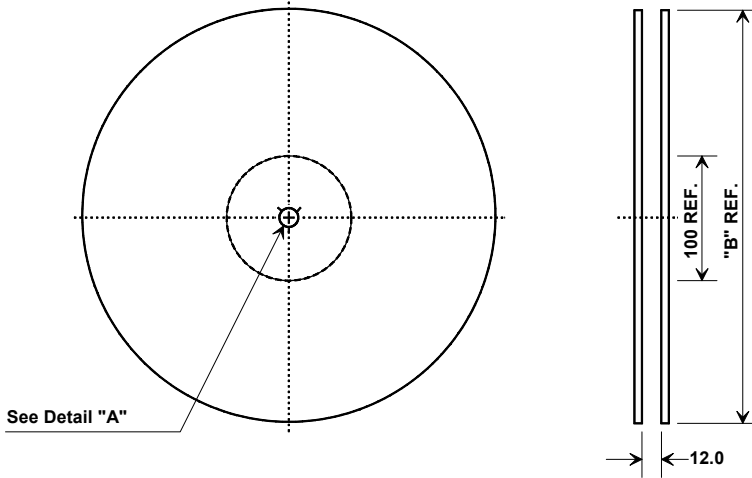

"B" Nominal Size		Quantity Per Reel	
Inches	millimeters	Min	Max
7	178	TBD	TBD
13	330	TBD	TBD

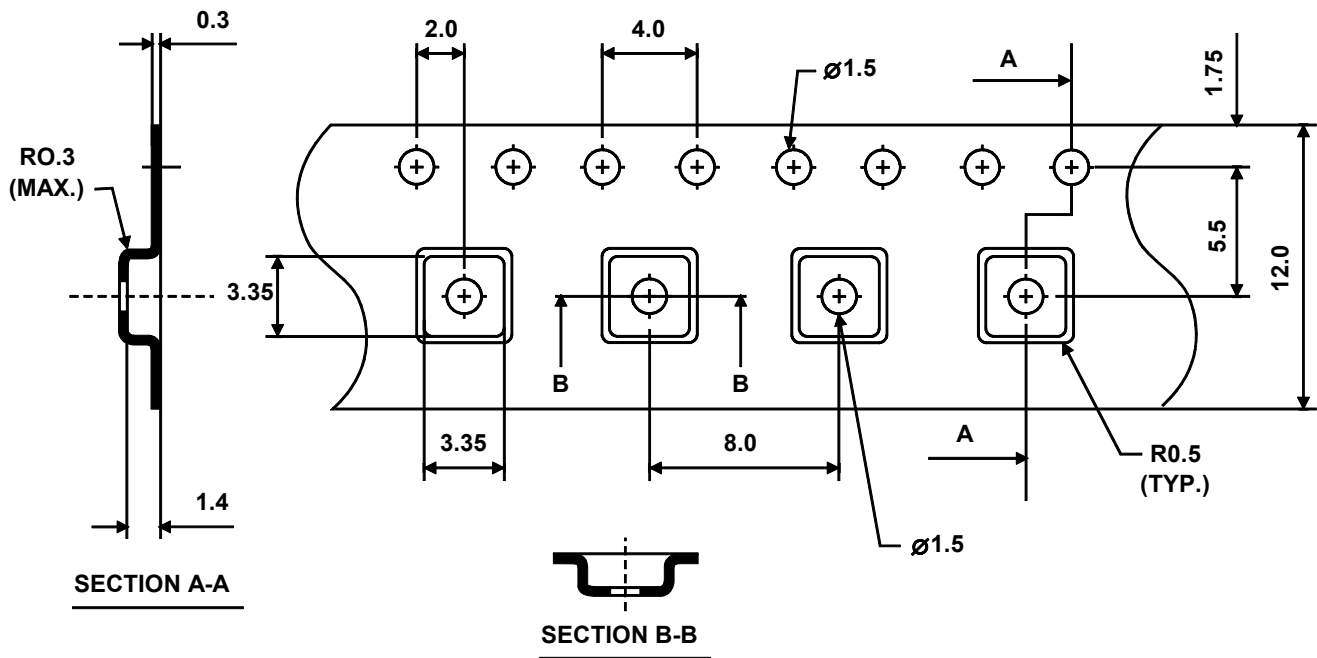
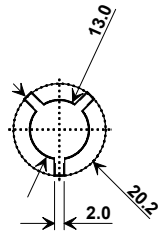

SM3030-6 Case

6-Terminal Ceramic Surface-Mount Case 3.0 X 3.0 mm Nominal Footprint

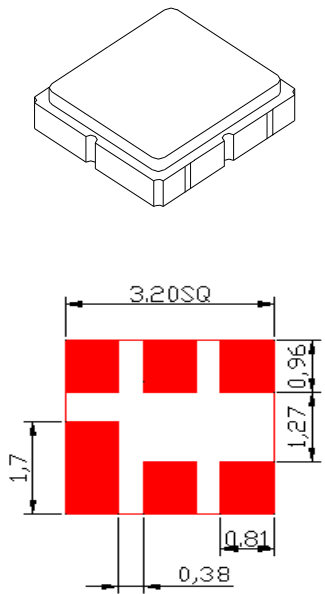

PCB FOOTPRINT

TOP VIEW

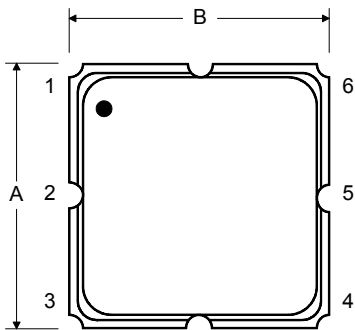

BOTTOM VIEW

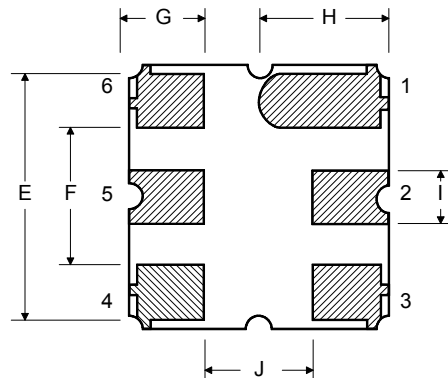

Case Dimensions

Dimension	mm			Inches		
	Min	Nom	Max	Min	Nom	Max
A		3.0			0.118	
B		3.0			0.118	
C		1.3			0.051	
D		0.9			0.035	
E		2.54			0.100	
F		1.6			0.063	
G		0.85			0.033	
H		1.5			0.059	
I		0.6			0.024	
J		1.3			0.051	

Electrical Connections

Connection		Terminals
Port 1	Single Ended Input	2
Port 2	Single Ended Output	5
	Ground	All others
Single Ended Operation Only		
Dot indicates Pin 1		