

LTM4650EY
Dual Phase Single 50A
DC/DC μ Module Regulator

DESCRIPTION

Demonstration circuit 2479A-A features the LTM[®]4650EY, the high efficiency, high density, dual 25A, single 50A switch mode step-down power module regulator. The input voltage is from 4.5V to 15V. The output voltage is programmable from 0.6V to 1.8V. DC2479A-A is configured as dual-phase, single-output, which can deliver up to 50A maximum. The board designs with minimum components to demonstrate this high efficiency, high density μ Module. As explained in the data sheet, output current de-rating is necessary for certain V_{IN} , V_{OUT} , and

thermal conditions. These features and the availability of the LTM4650EY in a compact 16mm \times 16mm \times 5.01mm BGA package make it ideal for use in many high-density point-of-load applications. The LTM4650 data sheet must be read in conjunction with this demo manual for working on or modifying the demo circuit DC2479A-A.

Design files for this circuit board are available at <http://www.linear.com/demo/DC2479A-A>

LT, LT, LTC, LTM, Linear Technology and the Linear logo are registered trademarks of Linear Technology Corporation. All other trademarks are the property of their respective owners.

BOARD PHOTO

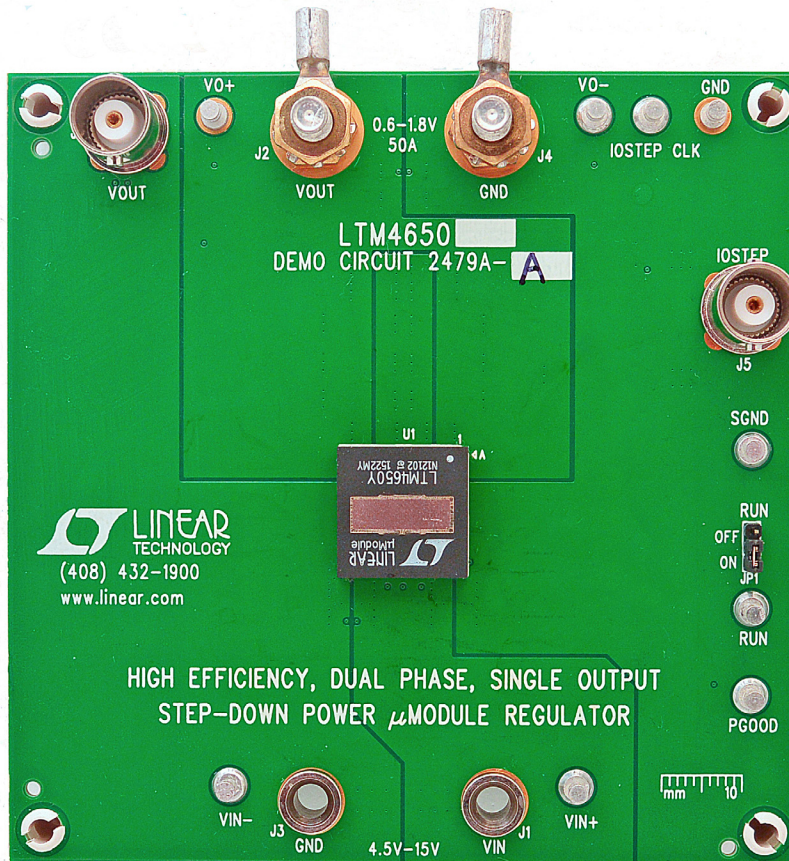

Figure 1. LTM4650/DC2479A-A Demo Board

DEMO MANUAL DC2479A-A

PERFORMANCE SUMMARY Specifications are at $T_A = 25^\circ\text{C}$

PARAMETER	CONDITIONS/NOTES	VALUE
Input Voltage Range		4.5V ~ 15V
Output Voltage V_{OUT}	$V_{IN} = 4.5\sim 15\text{V}$, $I_{OUT} = 0\sim 50\text{A}$	$1.0\text{V} \pm 1.5\%$ (0.985V ~ 1.015V)
Maximum Continuous Output Current	De-Rating is Necessary for Certain V_{IN} , V_{OUT} and Thermal Conditions, See Data Sheet for Detail.	50A
Default Operating Frequency		500kHz
Efficiency	$V_{IN} = 12\text{V}$, $V_{OUT} = 1.0\text{V}$, $I_{OUT} = 50\text{A}$, $f_{SW} = 500\text{ kHz}$	86.6%, See Figure 4
Load Transient	$V_{IN} = 12\text{V}$, $V_{OUT} = 1.0\text{V}$, $I_{STEP} = 25\text{A}$ to 37.5A	< 60mV _{P-P} , See Figure 5

QUICK START PROCEDURE

Demonstration circuit DC2479A-A is easy to set up to evaluate the performance of the LTM4650EY. Please refer to Figure 1 for proper measurement setup and follow the procedure below:

1. With power off, connect the input power supply, load and meters as shown in Figure 2. Preset the load to 0A and V_{IN} supply to 12V.
2. Turn on the power supply at the input. The output voltage should be $1.0\text{V} \pm 1.5\%$ (0.985V~1.015V).
3. Once the proper output voltage is established, adjust the load within the operating range and observe the output

voltage regulation, output voltage ripple, efficiency and other parameters. Output ripple can be measured at J6 with BNC cables.

4. (Optional) For optional load transient test, apply an adjustable pulse signal between “IOSTEP CLK” and “GND” test point. Pulse amplitude (3V~3.5V) sets the load step current amplitude. The output transient current can be monitored at the BNC connector J5 (10mV/A). The pulse signal should have very small duty cycle (< 10%) to limit the thermal stress on the transient load circuit.

QUICK START PROCEDURE

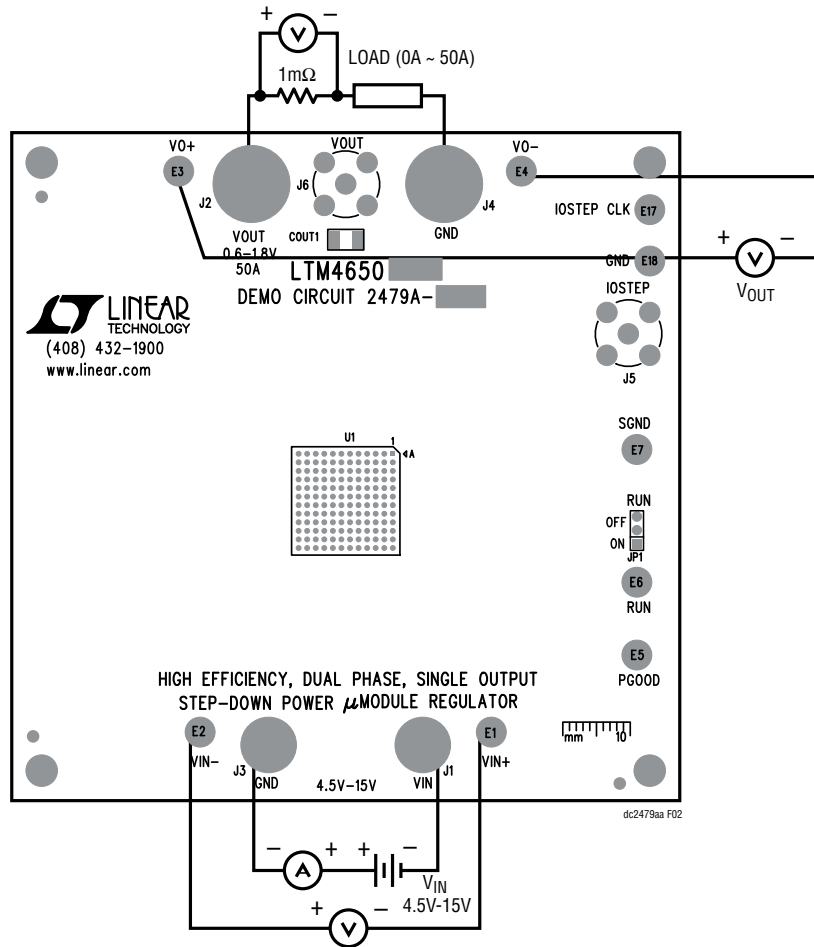

Figure 2. Test Setup of DC2479A-A

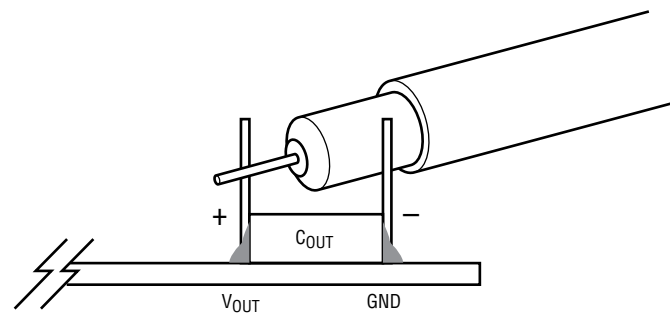

Figure 3. Measuring Output Voltage Ripple

QUICK START PROCEDURE

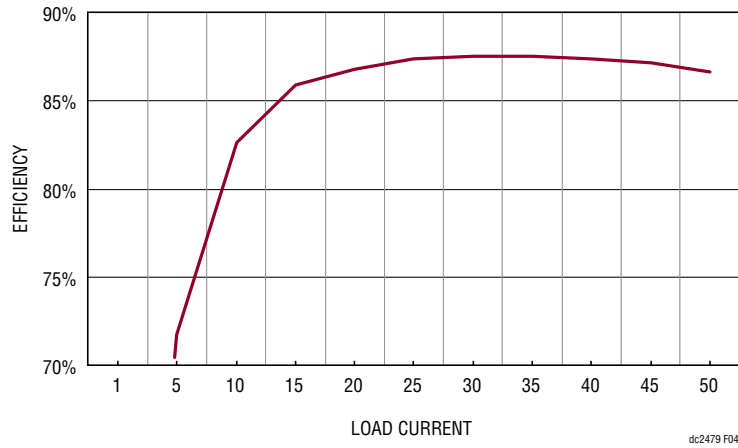

Figure 4. Efficiency vs Load Current at $V_{IN} = 12V$, $V_O = 1V$, $f_{SW} = 500kHz$

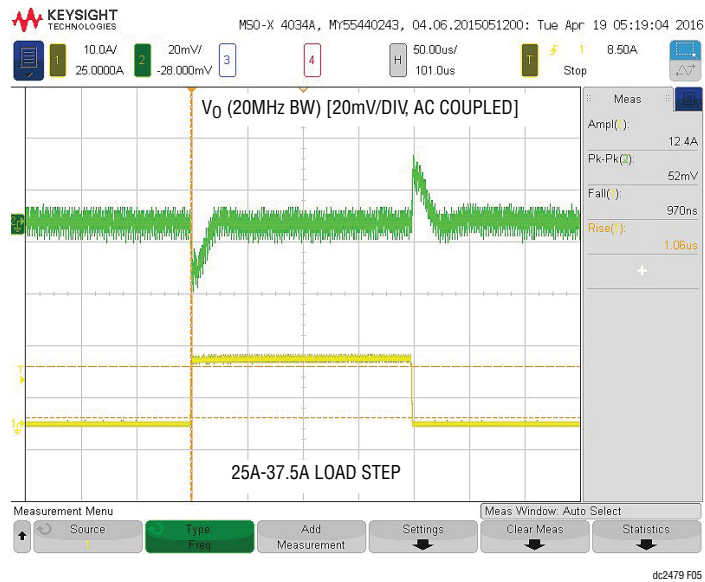

Figure 5. Measured 25A – 37.5A Load Transient Response ($V_{IN} = 12V$, $V_{OUT} = 1.0V$, $f_{SW} = 500kHz$)

QUICK START PROCEDURE

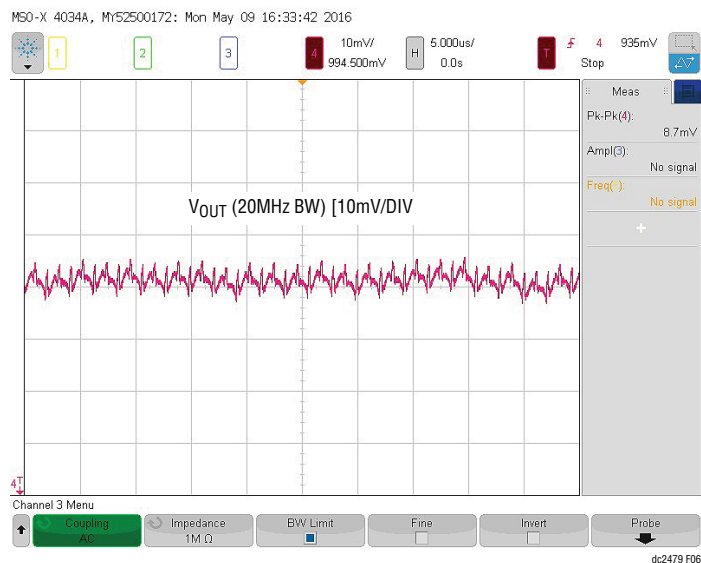

Figure 6. Output Voltage Ripple at $V_{IN} = 12V$, $V_{OUT} = 1V$, $I_{OUT} = 50A$, $f_{SW} = 500kHz$

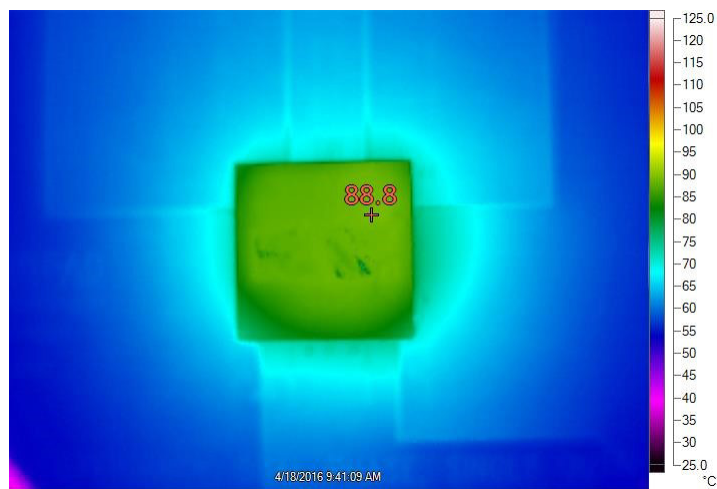

Figure 7. Thermal Performance at $V_{IN} = 12V$, $V_{OUT} = 1V$, $I_{OUT} = 50A$, $T_A = 23.8^\circ C$, No Air Flow

DEMO MANUAL DC2479A-A

PARTS LIST

ITEM	QTY	REFERENCE	PART DESCRIPTION	MANUFACTURER/PART NUMBER
Required Circuit Components				
1	1	CIN1	CAP, 150µF, 25V, Aluminum Electr.,	SUN ELECT., 25CE150AX
2	4	CIN2, CIN3, CIN4, CIN5	CAP, X5R, 22µF, 25V, 10%, 1210	MURATA, GRM32ER61E226KE15L
3	4	COUT2, COUT4, COUT6, COUT8	CAP, 470µF, 2.5V, POSCAP, F8 SANYO-D4D	PANASONIC, 2R5TPF470M6L
4	1	C4	CAP, X5R, 2.2µF, 10V, 10%, 0603	MURATA, GRM188R61A225KE34D
5	1	C7	CAP, X5R, 0.1µF, 25V, 10%, 0603	AVX, 06033D104KAT2A
6	3	C8, C9, C10	CAP, X7R, 1µF, 10V, 10%, 0603	AVX, 0603ZC105KAT2A
7	1	Q1	XSTR, SUD50N04-8M8P-4GE3 MOSFET	VISHAY, SUD50N04-8M8P-4GE3
8	2	R1, R3	RES., 10, 1%, 1/10W, 0603	VISHAY, CRCW060310R0FKEA
9	2	R2, R9	RES., 121k, 1%, 1/10W, 0603	VISHAY, CRCW0603121KFKEA
10	2	R4, R18	RES., 10k, 1%, 1/10W, 0603	VISHAY, CRCW060310K0FKEA
11	1	R11	RES., 1k, 1%, 1/10W, 0603	VISHAY, CRCW06031K00FKEA
12	1	R16	RES., 0.01Ω, 1W, 2512	VISHAY, WSL2512R0100FEA
13	1	R19	RES., 90.9k, 1%, 1/10W, 0603	VISHAY, CRCW060390K9FKEA
14	1	U1	LTM4650EY#PBF, 16x16x5.01 BGA	LINEAR TECH., LTM4650EY#PBF
Additional Demo Board Circuit Components				
1	8	COUT1, COUT3, COUT5, COUT7, COUT11, COUT12, COUT13, COUT14	CAP, X5R, 100µF, 6.3V, 20%, 1210	AVX, 12106D107MAT2A
2	0	COUT9, COUT10	CAP, OPT, SANYO-D4D	OPT
3	0	C1, C3, C5, C11	CAP, OPT, 0603	OPT
4	0	R8, R10	RES., OPT, 0603	OPT
5	2	R12, R14	RES., 0Ω, 1/10W, 0603	VISHAY, CRCW06030000Z0EA
6	0	R13	RES., OPT, 0603	OPT
7	0	R20	RES., OPT, 2512	OPT
Hardware: For Demo Board Only				
1	9	E1-E7, E17, E18	TESTPOINT, TURRET, .094"	MILL-MAX, 2501-2-00-80-00-00-07-0
2	0	E8-E14	TESTPAD SMD	TESTPAD SMD
3	1	JP1	HEADER, 3 PIN 2mm SINGLE ROW	WURTH ELEKTRONIK, 620-003-111-21
4	2	J1, J3	JACK BANANA	KEYSTONE, 575-4
5	2	J2, J4	STUD, TESTPIN	PEM KFH-032-10
6	4	J2, J4 (x2)	NUT, BRASS 10-32	ANY #10-32
7	2	J2, J4	RING, LUG #10	KEYSTONE #10
8	2	J2, J4	WASHER, TIN PLATED BRASS	ANY #10
9	2	J5, J6	CONN, BNC, 5 PINS	CONNEX 112404
10	1	XJP1	SHUNT 2mm	WURTH ELEKTRONIK, 608-002-134-21

SCHEMATIC DIAGRAM

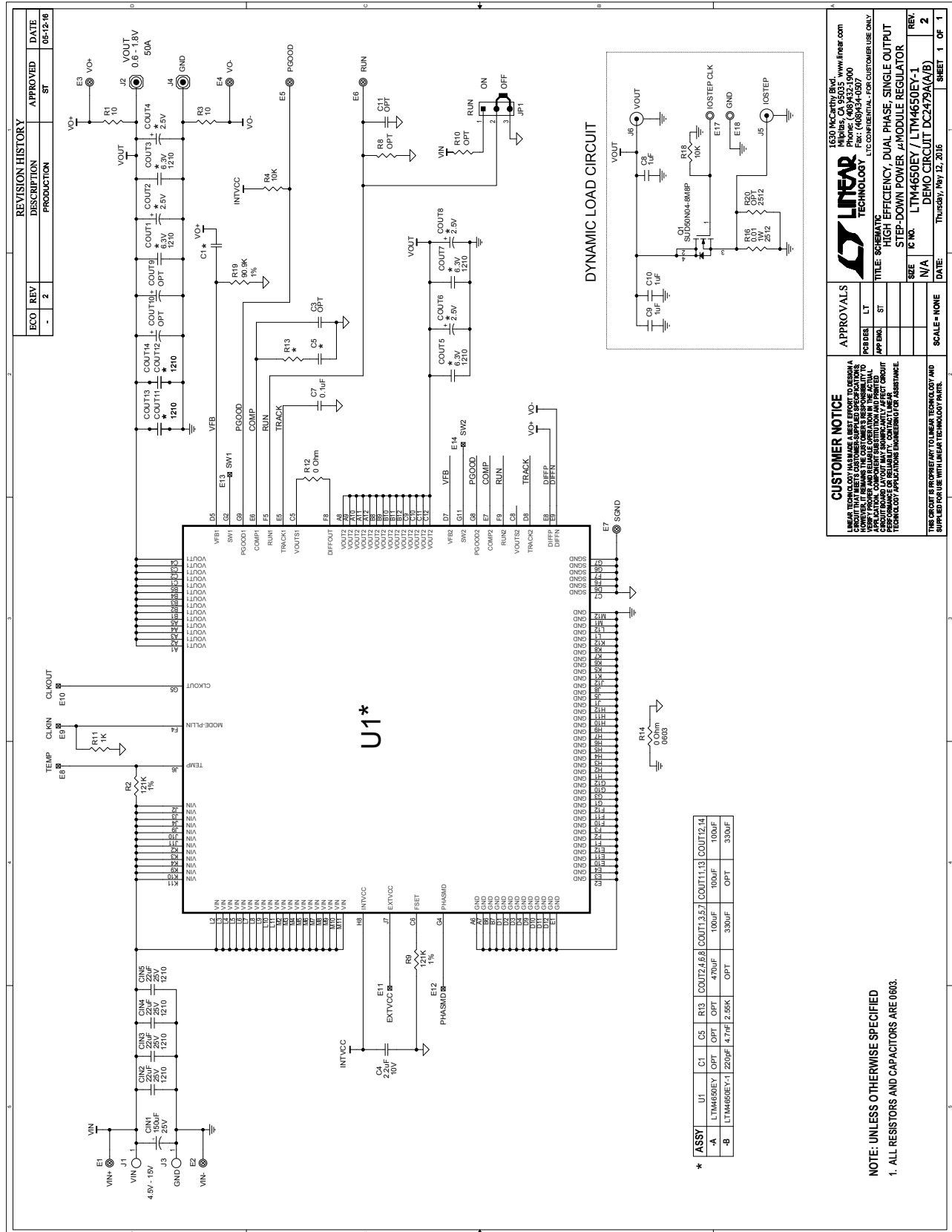

1630 McCarthy Blvd.
Folsom, CA 95635 www.linear.com
Tel: (916) 444-0000 Fax: (916) 444-0000
LTC CONSENTS TO THE CUSTOMER USE ONLY.

LINEAR TECHNOLOGY

TITLE: SCHEMATIC
DESCRIPTION: HIGH EFFICIENCY, DUAL PHASE, SINGLE OUTPUT STEP-DOWN POWER μMODULE REGULATOR

IC NO.: LTM4650EY / LTM4650EY-1
DEMO CIRCUIT: DC2479A(A/B)

REV.: 2
DATE: Thursday, May 12, 2016
SHEET: 1 OF 1

DEMO MANUAL DC2479A-A

DEMONSTRATION BOARD IMPORTANT NOTICE

Linear Technology Corporation (LTC) provides the enclosed product(s) under the following **AS IS** conditions:

This demonstration board (DEMO BOARD) kit being sold or provided by Linear Technology is intended for use for **ENGINEERING DEVELOPMENT OR EVALUATION PURPOSES ONLY** and is not provided by LTC for commercial use. As such, the DEMO BOARD herein may not be complete in terms of required design-, marketing-, and/or manufacturing-related protective considerations, including but not limited to product safety measures typically found in finished commercial goods. As a prototype, this product does not fall within the scope of the European Union directive on electromagnetic compatibility and therefore may or may not meet the technical requirements of the directive, or other regulations.

If this evaluation kit does not meet the specifications recited in the DEMO BOARD manual the kit may be returned within 30 days from the date of delivery for a full refund. **THE FOREGOING WARRANTY IS THE EXCLUSIVE WARRANTY MADE BY THE SELLER TO BUYER AND IS IN LIEU OF ALL OTHER WARRANTIES, EXPRESSED, IMPLIED, OR STATUTORY, INCLUDING ANY WARRANTY OF MERCHANTABILITY OR FITNESS FOR ANY PARTICULAR PURPOSE. EXCEPT TO THE EXTENT OF THIS INDEMNITY, NEITHER PARTY SHALL BE LIABLE TO THE OTHER FOR ANY INDIRECT, SPECIAL, INCIDENTAL, OR CONSEQUENTIAL DAMAGES.**

The user assumes all responsibility and liability for proper and safe handling of the goods. Further, the user releases LTC from all claims arising from the handling or use of the goods. Due to the open construction of the product, it is the user's responsibility to take any and all appropriate precautions with regard to electrostatic discharge. Also be aware that the products herein may not be regulatory compliant or agency certified (FCC, UL, CE, etc.).

No License is granted under any patent right or other intellectual property whatsoever. **LTC assumes no liability for applications assistance, customer product design, software performance, or infringement of patents or any other intellectual property rights of any kind.**

LTC currently services a variety of customers for products around the world, and therefore this transaction **is not exclusive**.

Please read the DEMO BOARD manual prior to handling the product. Persons handling this product must have electronics training and observe good laboratory practice standards. **Common sense is encouraged.**

This notice contains important safety information about temperatures and voltages. For further safety concerns, please contact a LTC application engineer.

Mailing Address:

Linear Technology
1630 McCarthy Blvd.
Milpitas, CA 95035

Copyright © 2004, Linear Technology Corporation