

Base strip - FK-MPT 0,5/ 5-ICV-3,5 - 1905528

Please be informed that the data shown in this PDF Document is generated from our Online Catalog. Please find the complete data in the user's documentation. Our General Terms of Use for Downloads are valid (<http://phoenixcontact.com/download>)



Header, Nominal current: 3 A, Rated voltage (III/2): 250 V, Number of positions: 5, Pitch: 3.5 mm, Color: green, Contact surface: Tin, Assembly: Soldering, The touch-protected basic strip, serves to accommodate the FK-MPT 0,5 PCB terminal block.

The illustration shows a 15-position version



Key commercial data

| | |
|--------------------------------------|----------|
| Packing unit | 1 pc |
| Minimum order quantity | 50 pc |
| Weight per Piece (excluding packing) | 1.16 GRM |
| Custom tariff number | 85366990 |
| Country of origin | Germany |

Technical data

Dimensions

| | |
|----------------|--------------|
| Length | 9.1 mm |
| Pitch | 3.5 mm |
| Dimension a | 14 mm |
| Pin dimensions | 0,3 x 0,9 mm |
| Pin spacing | 3.50 mm |
| Hole diameter | 1 mm |

General

| | |
|-----------------------------|-------------------|
| Range of articles | FK-MPT 0,5/..-ICV |
| Insulating material group | IIIa |
| Rated surge voltage (III/3) | 2.5 kV |
| Rated surge voltage (III/2) | 2.5 kV |
| Rated surge voltage (II/2) | 2.5 kV |
| Rated voltage (III/3) | 160 V |

Base strip - FK-MPT 0,5/ 5-ICV-3,5 - 1905528

Technical data

General

| | |
|---|--------|
| Rated voltage (III/2) | 250 V |
| Rated voltage (II/2) | 250 V |
| Connection in acc. with standard | EN-VDE |
| Nominal current I _N | 3 A |
| Maximum load current | 3 A |
| Insulating material | PA |
| Inflammability class according to UL 94 | V0 |
| Color | green |
| Number of positions | 5 |

Classifications

eCl@ss

| | |
|------------|----------|
| eCl@ss 4.0 | 272607xx |
| eCl@ss 4.1 | 27260701 |
| eCl@ss 5.0 | 27260701 |
| eCl@ss 5.1 | 27260701 |
| eCl@ss 6.0 | 27260704 |
| eCl@ss 7.0 | 27440402 |
| eCl@ss 8.0 | 27440402 |

ETIM

| | |
|----------|----------|
| ETIM 3.0 | EC001121 |
| ETIM 4.0 | EC002637 |
| ETIM 5.0 | EC002637 |

UNSPSC

| | |
|---------------|----------|
| UNSPSC 6.01 | 30211801 |
| UNSPSC 7.0901 | 39121432 |
| UNSPSC 11 | 34131203 |
| UNSPSC 12.01 | 39121432 |
| UNSPSC 13.2 | 39121432 |

Approvals

Approvals

Base strip - FK-MPT 0,5/ 5-ICV-3,5 - 1905528

Approvals

Approvals

UL Recognized / cUL Recognized / GOST / GOST / cULus Recognized

Ex Approvals

Approvals submitted

Approval details

| | | |
|--------------------------------|-------|-------|
| UL Recognized | | |
| | B | D |
| Nominal current I _N | 4 A | 4 A |
| Nominal voltage U _N | 300 V | 300 V |

| | | |
|--------------------------------|-------|-------|
| cUL Recognized | | |
| | B | D |
| Nominal current I _N | 4 A | 4 A |
| Nominal voltage U _N | 300 V | 300 V |

| | | |
|------|--|--|
| GOST | | |
|------|--|--|

| | | |
|------|--|--|
| GOST | | |
|------|--|--|

| | | |
|------------------|--|--|
| cULus Recognized | | |
|------------------|--|--|

Drawings

Base strip - FK-MPT 0,5/ 5-ICV-3,5 - 1905528

Drilling diagram

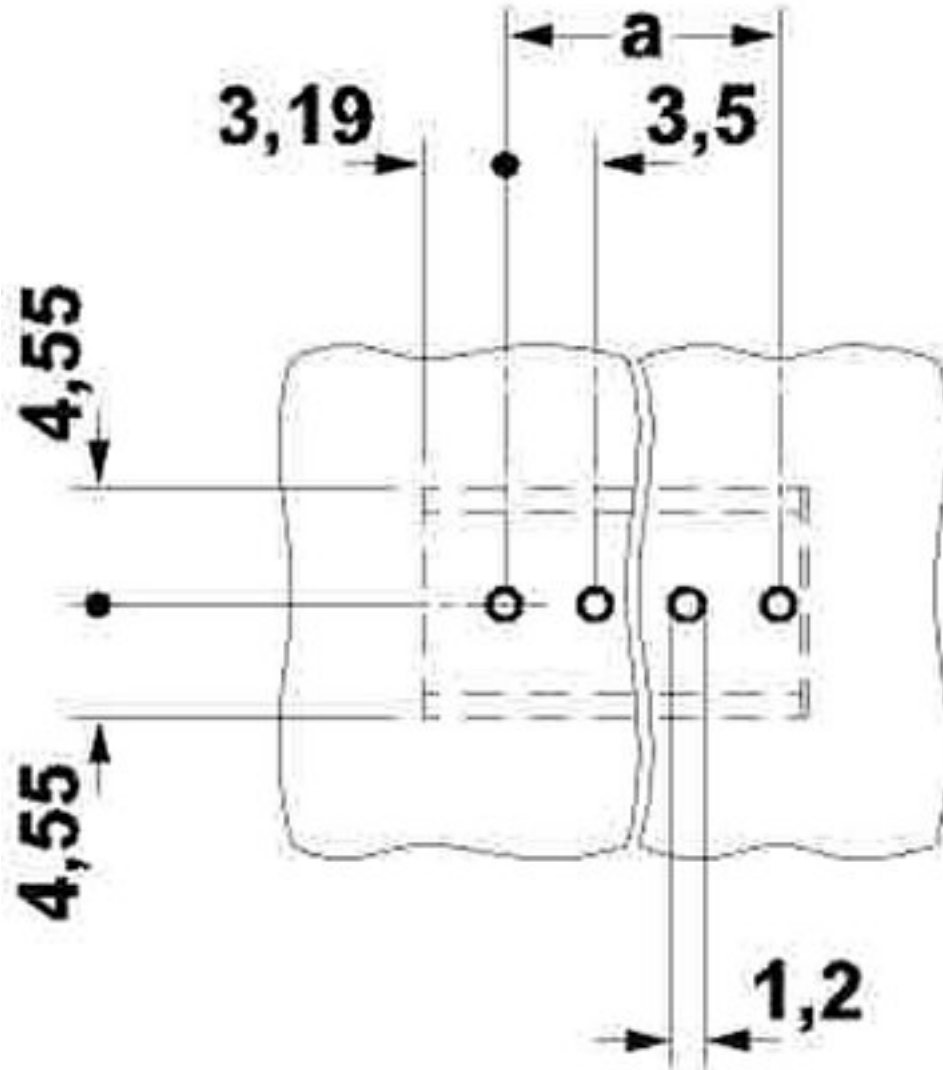

Base strip - FK-MPT 0,5/ 5-ICV-3,5 - 1905528

Dimensioned drawing

