

## L6730: 20A Demoboard

Data Brief

### General description

L6730 demoboard realizes in a four layer PCB a step-down DC/DC converter and shows the operation of the device in a general purpose application. The input voltage can range from 4.5 V to 14 V and the output voltage is at 3.3 V. The module can deliver an output current in excess of 30A. The switching frequency is set at 400 KHz (controller free-running  $F_{SW}$ ) but it can be increased up to 1 MHz. A 7 positions dip-switch allows to select the UVLO threshold (5 V or 12 V Bus), the OVP intervention mode and the sink-mode current capability.

### Demoboard picture

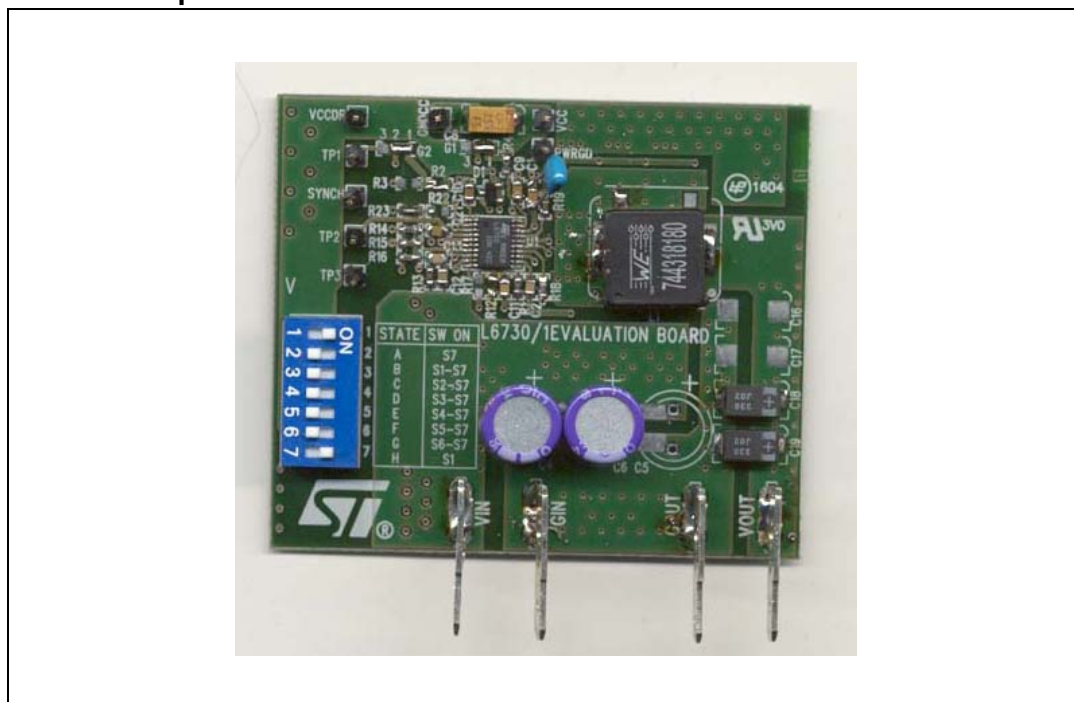

# 1 Features

Figure 1. Demoboard schematic

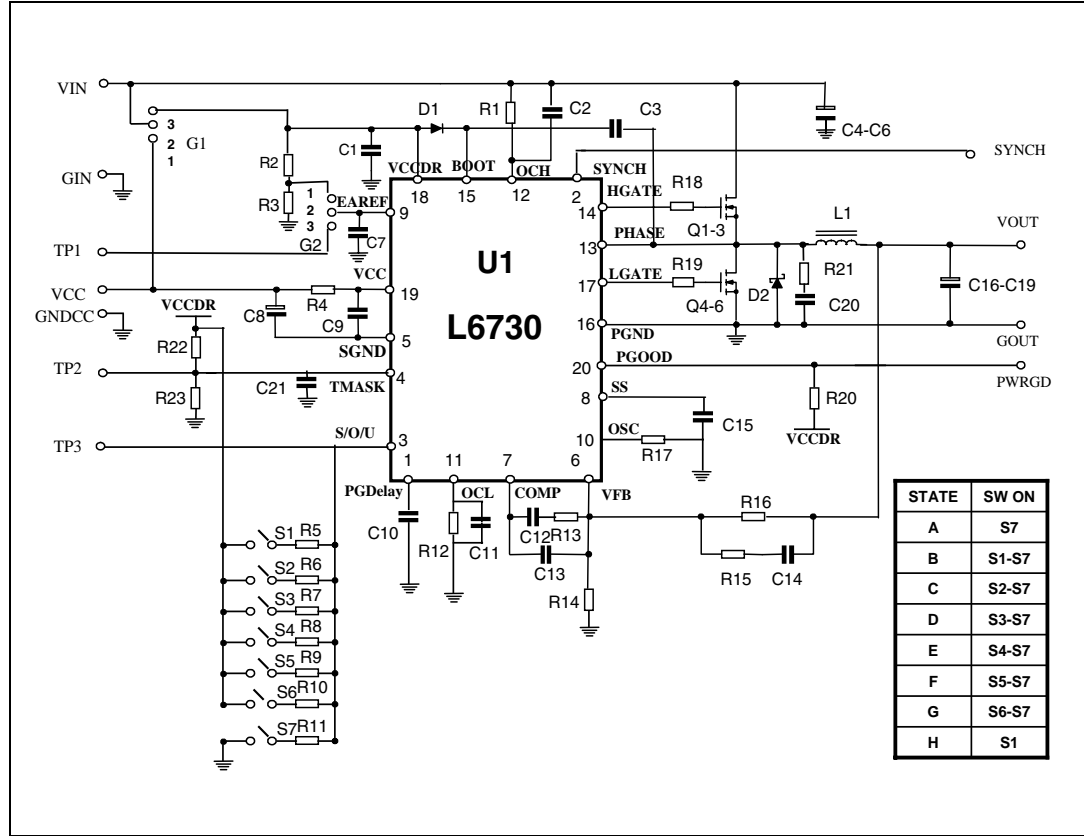

Table 1. Demoboard part list

Reference	Value	Manufacturer	Package	Supplier
R1	820 Ω	Neohm	SMD 0603	IFARCAD
R2	0 Ω	Neohm	SMD 0603	IFARCAD
R3	N.C.			
R4	10 Ω 1% 100 mW	Neohm	SMD 0603	IFARCAD
R5	11 KΩ 1% 100 mW	Neohm	SMD 0603	IFARCAD
R6	6.2 KΩ 1% 100 mW	Neohm	SMD 0603	IFARCAD
R7	4.3 KΩ 1% 100 mW	Neohm	SMD 0603	IFARCAD
R8	2.7 KΩ 1% 100 mW	Neohm	SMD 0603	IFARCAD
R9	1.8 KΩ 1% 100 mW	Neohm	SMD 0603	IFARCAD
R10	1.2 KΩ 1% 100 mW	Neohm	SMD 0603	IFARCAD
R11	2.7 KΩ 1% 100 mW	Neohm	SMD 0603	IFARCAD
R12	1 KΩ	Neohm	SMD 0603	IFARCAD
R13	2.7 KΩ 1% 100 mW	Neohm	SMD 0603	IFARCAD

Table 1. Demoboard part list (continued)

Reference	Value	Manufacturer	Package	Supplier
R14	1 K $\Omega$ 1% 100mW	Neohm	SMD 0603	IFARCAD
R15	1 K $\Omega$ 1% 100mW	Neohm	SMD 0603	IFARCAD
R16	4.7 K $\Omega$ 1% 100mW	Neohm	SMD 0603	IFARCAD
R17	N.C.			
R18	2.2 $\Omega$	Neohm	SMD 0603	IFARCAD
R19	2.2 $\Omega$	Neohm	SMD 0603	IFARCAD
R20	10 K $\Omega$ 1% 100 mW	Neohm	SMD 0603	IFARCAD
R21	N.C.			
R22	N.C.			
R23	0 $\Omega$	Neohm	SMD 0603	IFARCAD
C1	220 nF	Kemet	SMD 0603	IFARCAD
C3-C7-C9-C15-C21	100 nF	Kemet	SMD 0603	IFARCAD
C2	1 nF.	Kemet	SMD 0603	IFARCAD
C4-C6	100 $\mu$ F 20V	OSCON 20SA100M	RADIAL 10X10.5	SANYO
C8	4.7 $\mu$ F 20V	AVX	SMA6032	IFARCAD
C10	10 nF	Kemet	SMD 0603	IFARCAD
C11	N.C.			
C12	47 nF	Kemet	SMD 0603	IFARCAD
C13	1.5 nF	Kemet	SMD 0603	IFARCAD
C14	4.7nF	Kemet	SMD 0603	IFARCAD
C18-C19	330 $\mu$ F 6.3V	POSCAP 6TPB330M	SMD	SANYO
C20	N.C.			
L1	1.8 $\mu$ H	Panasonic	SMD	ST
D1	1N4148	ST	SOT23	IFARCAD
D2	STS1L30M	ST	DO216AA	ST
Q1-Q2	STS12NH3LL	ST	SO8	ST
Q4-Q5	STSJ100NH3LL	ST	SO8	ST
U1	L6730	ST	QFN 4x4 24L	ST
SWITCH	DIP SWITCH 7 POS.			ST

Table 2. Other inductor manufacturer

Manufacturer	Series	Inductor value ( $\mu$ H)	Saturation current (A)
WURTH ELEKTRONIC	744318180	1.8	20
SUMIDA	CDEP134-2R7MC-H	2.7	15
EPCOS	HPI_13 T640	1.4	22

**Table 2. Other inductor manufacturer**

Manufacturer	Series	Inductor value (µH)	Saturation current (A)
TDK	SPM12550T-1R0M220	1	22
TOKO	FDA1254	2.2	14
COILTRONICS	HCF1305-1R0	1.15	22
	HC5-1R0	1.3	27

**Table 3. Other capacitor manufacturer**

Manufacturer	Series	Capacitor value(µF)	Rated voltage (V)
TDK	C4532X5R1E156M	15	25
	C3225X5R0J107M	100	6.3
NIPPON CHEMI-CON	25PS100MJ12	100	25
PANASONIC	ECJ4YB0J107M	100	6.3

## 1.1 I/O description

**Figure 2. I/O description**

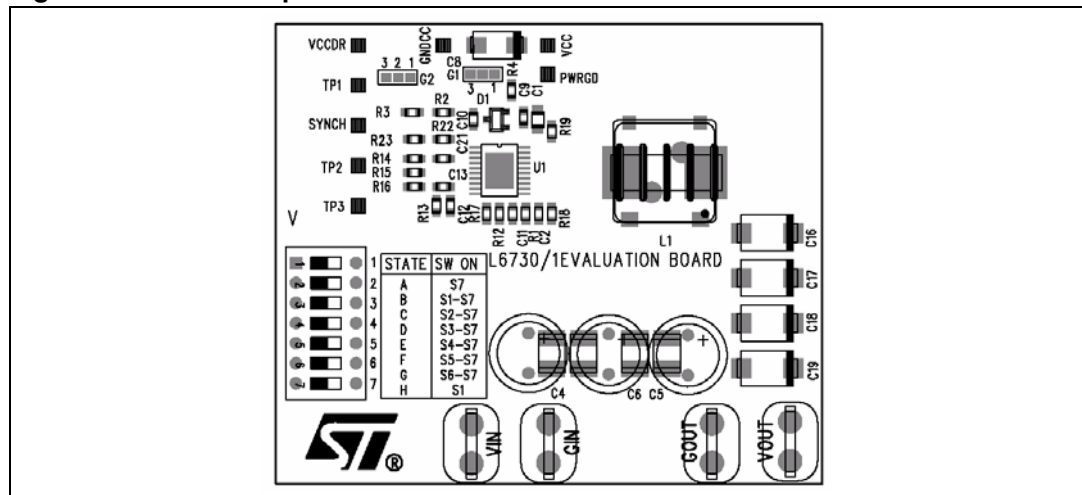

- Input (Vin-Gin):

The input voltage can range from 1.8 V to 14 V. If the input voltage is between 4.5 V and 14 V it can supply also the device (through the Vcc pin) and in this case the pin 1 and 2 of the jumper G1 must be connected together.

- Output (Vout-Gout):

The output voltage is fixed at 3.3 V but it can be changed by replacing the resistor R14 of the output resistor divider:

$$V_O = V_{REF} \cdot \left(1 + \frac{R_{16}}{R_{14}}\right)$$

The over-current-protection limit is set at 15 A but it can be changed by replacing the resistors R1 and R12 (see OCL and OCH pin).

- Vcc-Gndcc:

Using the input voltage to supply the controller no power is required at this input. However the controller can be supplied separately from the power stage through the Vcc input (4.5-14V) and, in this case, jumper G1 must be left open.

- V<sub>CCDR</sub>:

An internal LDO provides the power into the device. The input of this stage is the Vcc pin and the output (5 V) is the V<sub>CCDR</sub> pin. The LDO can be bypassed, providing directly a 5 V voltage from V<sub>CCDR</sub> and Gndcc. In this case the pins 1 and 3 of the jumper G1 must be shorted.

- TP1:

This pin can be used as an input or as a test point. If all the jumper G2 pins are shorted, TP1 can be used as a test point of the voltage at the EAREF pin.

If the pins 2 and 3 of G2 are connected together, TP1 can be used as an input to provide an external reference for the internal error amplifier.

- TP2:

This test point is connected to the Tmask pin.

- TP3:

This test point is connected to the S/O/U pin.

- SYNCH:

This pin is connected to the synch pin of the controller.

- PWRGD:

This pin is connected to the PGOOD pin of the controller.

- DIP SWITCH

Different positions of the dip switch correspond to different settings of the multifunction pin (S/O/U) (CC/O/U).

**Table 4. Dip switch**

UVLO	OVP	SINK CC	V <sub>so</sub> /V <sub>CCDR</sub>	DIP SWITCH	STATE
5 V	Not latched	Not	0	S7	A
5 V	Not latched	Yes	0.2	S1-S7	B
5 V	Latched	Not	0.3	S2-S7	C
5 V	Latched	Yes	0.4	S3-S7	D
12 V	Not latched	Not	0.5	S4-S7	E
12 V	Not latched	Yes	0.6	S5-S7	F
12 V	Latched	Not	0.7	S6-S7	G
12 V	Latched	Yes	1	S1	H

## 1.2 Efficiency

The following figures show the demoboard efficiency versus load current for different values of input voltage and switching frequency:

**Figure 3. Demoboard efficiency - Fsw=400 KHz**

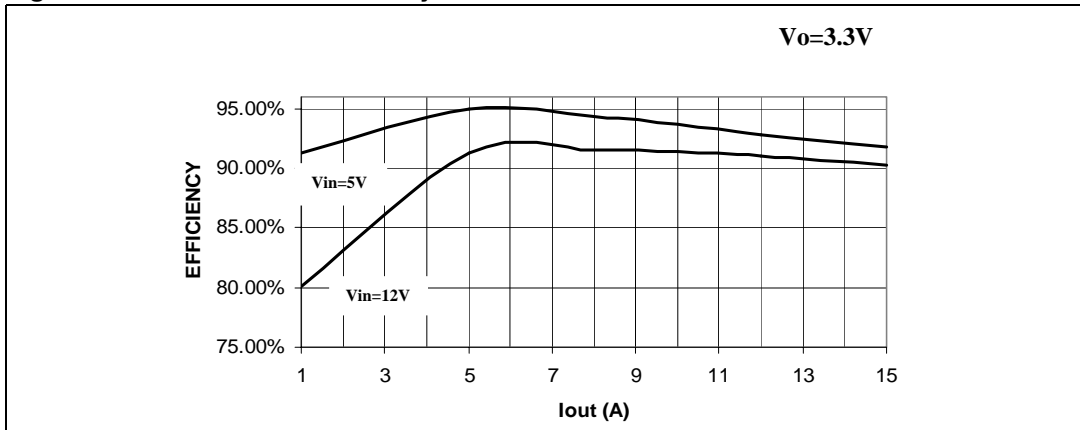

**Figure 4. Demoboard efficiency - Fsw=645 KHz**

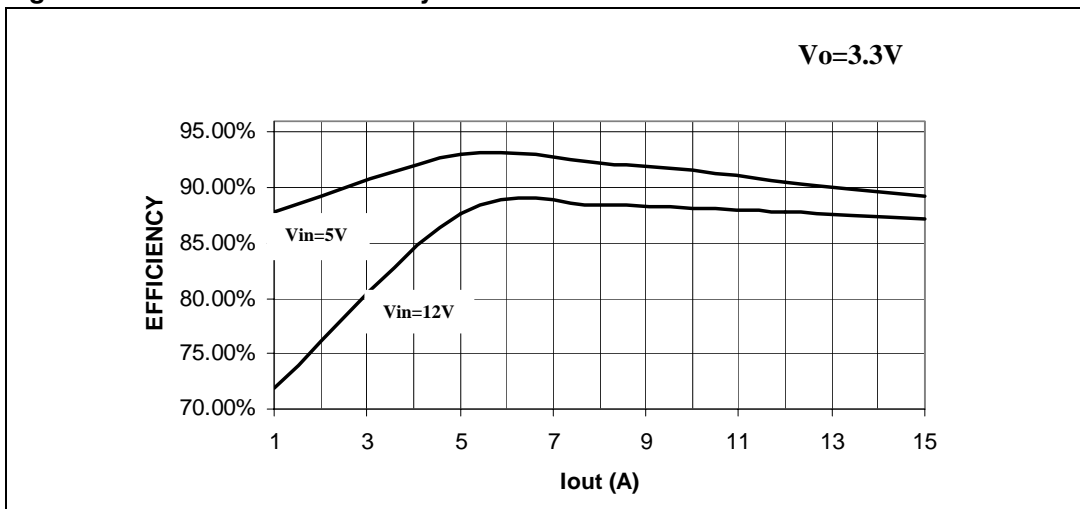

Figure 5. Demoboard efficiency - Fsw=1 MHz

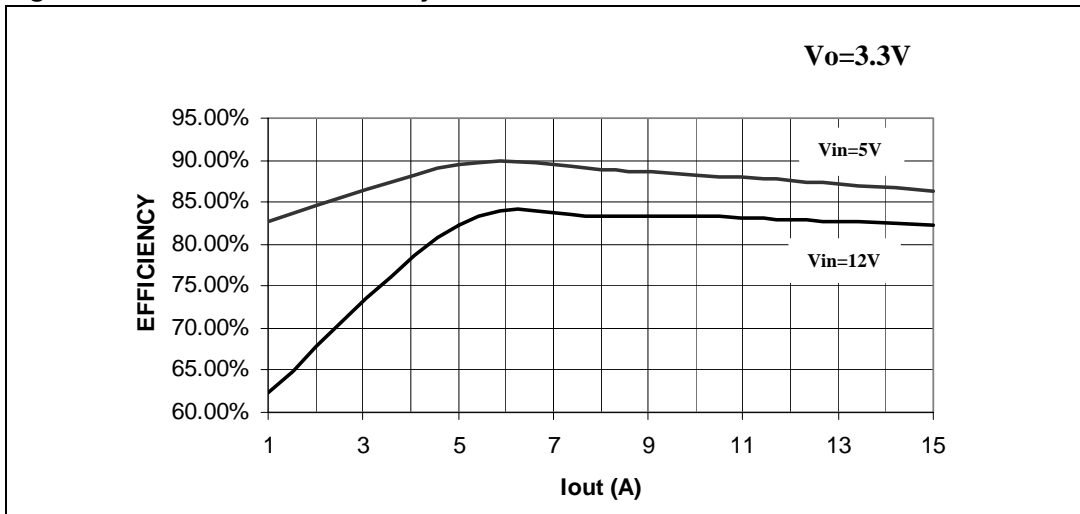
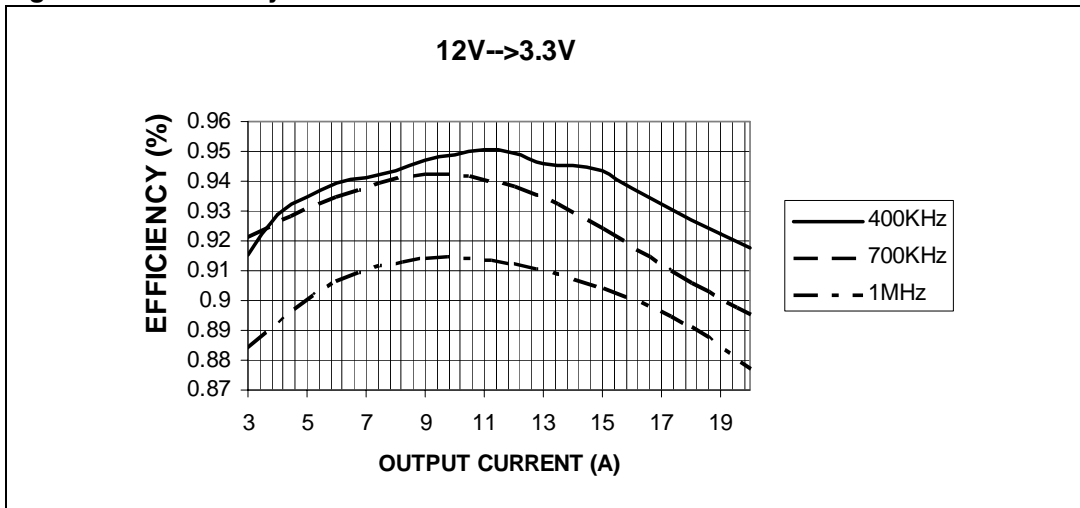

Figure 6. Efficiency with 2xSTS12NH3LL+2XSTSJ100NH3LL



## 2 Pictures of demoboard EVAL6730

Figure 7. PCB layout - top layer

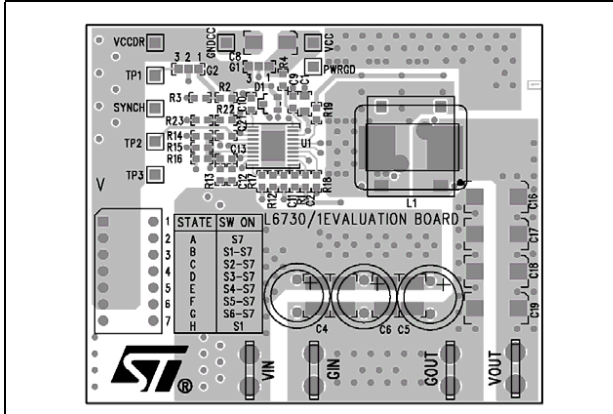

Figure 8. PCB layout - power ground layer

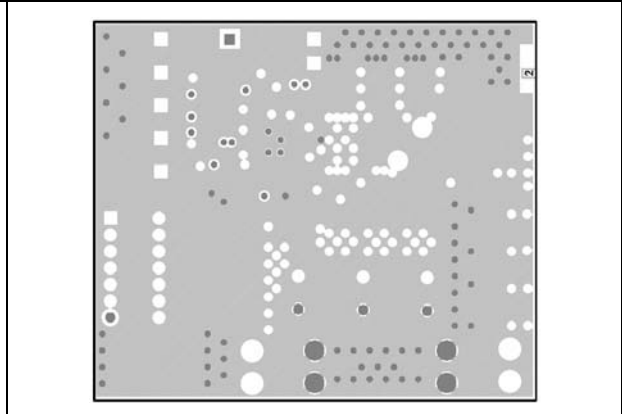

Figure 9. PCB layout - Signal-ground layer

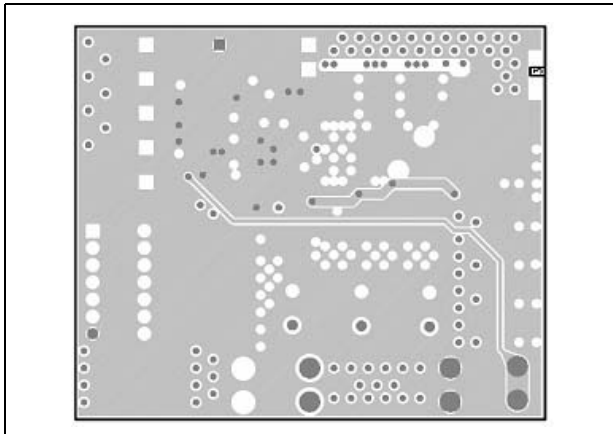
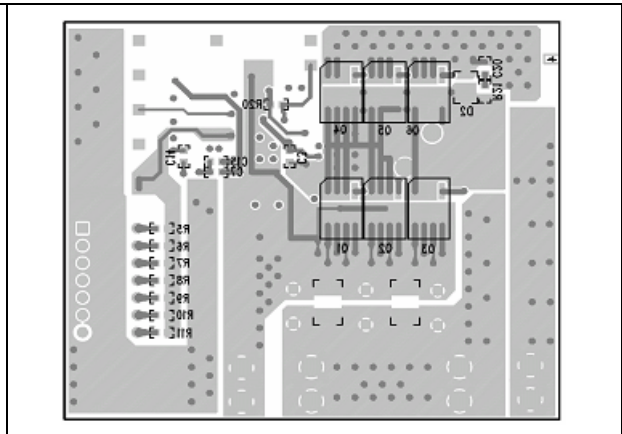

Figure 10. PCB layout - bottom layer



## 3 Revision history

Table 5. Revision history

Date	Revision	Changes
03-Jan-2007	1	First issue



**Please Read Carefully:**

Information in this document is provided solely in connection with ST products. STMicroelectronics NV and its subsidiaries ("ST") reserve the right to make changes, corrections, modifications or improvements, to this document, and the products and services described herein at any time, without notice.

All ST products are sold pursuant to ST's terms and conditions of sale.

Purchasers are solely responsible for the choice, selection and use of the ST products and services described herein, and ST assumes no liability whatsoever relating to the choice, selection or use of the ST products and services described herein.

No license, express or implied, by estoppel or otherwise, to any intellectual property rights is granted under this document. If any part of this document refers to any third party products or services it shall not be deemed a license grant by ST for the use of such third party products or services, or any intellectual property contained therein or considered as a warranty covering the use in any manner whatsoever of such third party products or services or any intellectual property contained therein.

**UNLESS OTHERWISE SET FORTH IN ST'S TERMS AND CONDITIONS OF SALE ST DISCLAIMS ANY EXPRESS OR IMPLIED WARRANTY WITH RESPECT TO THE USE AND/OR SALE OF ST PRODUCTS INCLUDING WITHOUT LIMITATION IMPLIED WARRANTIES OF MERCHANTABILITY, FITNESS FOR A PARTICULAR PURPOSE (AND THEIR EQUIVALENTS UNDER THE LAWS OF ANY JURISDICTION), OR INFRINGEMENT OF ANY PATENT, COPYRIGHT OR OTHER INTELLECTUAL PROPERTY RIGHT.**

**UNLESS EXPRESSLY APPROVED IN WRITING BY AN AUTHORIZED ST REPRESENTATIVE, ST PRODUCTS ARE NOT RECOMMENDED, AUTHORIZED OR WARRANTED FOR USE IN MILITARY, AIR CRAFT, SPACE, LIFE SAVING, OR LIFE SUSTAINING APPLICATIONS, NOR IN PRODUCTS OR SYSTEMS WHERE FAILURE OR MALFUNCTION MAY RESULT IN PERSONAL INJURY, DEATH, OR SEVERE PROPERTY OR ENVIRONMENTAL DAMAGE. ST PRODUCTS WHICH ARE NOT SPECIFIED AS "AUTOMOTIVE GRADE" MAY ONLY BE USED IN AUTOMOTIVE APPLICATIONS AT USER'S OWN RISK.**

Resale of ST products with provisions different from the statements and/or technical features set forth in this document shall immediately void any warranty granted by ST for the ST product or service described herein and shall not create or extend in any manner whatsoever, any liability of ST.

ST and the ST logo are trademarks or registered trademarks of ST in various countries.

Information in this document supersedes and replaces all information previously supplied.

The ST logo is a registered trademark of STMicroelectronics. All other names are the property of their respective owners.

© 2007 STMicroelectronics - All rights reserved

STMicroelectronics group of companies

Australia - Belgium - Brazil - Canada - China - Czech Republic - Finland - France - Germany - Hong Kong - India - Israel - Italy - Japan - Malaysia - Malta - Morocco - Singapore - Spain - Sweden - Switzerland - United Kingdom - United States of America

[www.st.com](http://www.st.com)