

## FEATURES

- 20 WATTS MAXIMUM OUTPUT POWER
- OUTPUT CURRENT UP TO 5.5A
- STANDARD 2.0 X 1.0 X 0.4 INCH PACKAGE
- HIGH EFFICIENCY UP TO 89%
- 4:1 ULTRA WIDE INPUT VOLTAGE RANGE
- SIX-SIDED CONTINUOUS SHIELD
- FIXED SWITCHING FREQUENCY
- ISO9001 CERTIFIED MANUFACTURING FACILITIES
- COMPLIANT TO RoHS EU DIRECTIVE 2002/95/EC



## OPTIONS

Negative logic Remote On/Off

## DESCRIPTION

The MT20E-W series offer 20 watts of output power from a 2 x 1 x 0.4 inch package. The MT20E-W series with 4:1 ultra wide input voltage of 9-36 and 18-75VDC and features 1600VDC of isolation, short-circuit and over-voltage protection.

## APPLICATIONS

Wireless Network  
Telecom/Datacom  
Industry Control System  
Measurement Equipment  
Semiconductor Equipment

## TECHNICAL SPECIFICATION All specifications are typical at nominal input, full load and 25°C otherwise noted

OUTPUT SPECIFICATIONS			
Output power			20 Watts, max.
Voltage accuracy	Full load and nominal Vin		± 1%
Minimum load			0%
Voltage adjustability	Single output		± 10%
Line regulation	LL to HL at Full Load	Single	± 0.2%
		Dual	± 0.5%
Load regulation	No Load to Full Load	Single	± 0.5%
		Dual	± 1%
Cross regulation (Dual)	Asymmetrical load 25% / 100% FL		± 5%
Ripple and noise	20MHz bandwidth (Measured with a 0.1µF/50V MLCC)		See table
Temperature coefficient			±0.02% / °C, max.
Transient response recovery time	25% load step change		250µS
Over voltage protection	3.3V output		3.9VDC
	5V output		6.2VDC
Zener diode clamp	12V output		15VDC
	15V output		18VDC
Over load protection	% of FL at nominal input		150%, typ.
Short circuit protection			Hiccup, automatics recovery

GENERAL SPECIFICATIONS			
Efficiency			See table
Isolation voltage	Input to Output		1600VDC, min.
	Input(Output) to case		1600VDC, min.
Case grounding			Connect case to -Vin with decoupling Y Cap
Isolation resistance			10 <sup>9</sup> ohms, min.
Isolation capacitance			1500pF, max.
Switching frequency			400KHz, typ.
Case material			Nickel-coated copper
Base material			FR4 PCB
Potting material			Epoxy (UL94-V0)
Dimensions			2.00 X 1.00 X 0.40 Inch (50.8X 25.4 X 10.2 mm)
Weight			27g (0.95oz)
MTBF (Note 1)	BELLCORE TR-NWT-000332		1.620 x 10 <sup>6</sup> hrs
	MIL-HDBK-217F		6.590 x 10 <sup>5</sup> hrs

INPUT SPECIFICATIONS			
Input voltage range	24V nominal input		9 – 36VDC
	48V nominal input		18 – 75VDC
Input filter			Pi type
Input surge voltage 100mS max	24V input		50VDC
	48V input		100VDC
Input reflected ripple current	Nominal Vin and full load		20mA <sub>p-p</sub>
Start up time	Nominal Vin and constant resistive load	Power up	20mS, typ.
		Remote ON/OFF	20mS, typ.
Start-up voltage	24V input		9VDC
	48V input		18VDC
Shutdown voltage	24V input		7.5VDC
	48V input		15VDC
Remote ON/OFF (Note 6) (Positive logic)(Standard)	DC-DC ON		Open or 3V < Vr < 12V
	DC-DC OFF		Short or 0V < Vr < 1.2V
(Negative logic)(Option)	DC-DC ON		Short or 0V < Vr < 1.2V
	DC-DC OFF		Open or 3V < Vr < 12V
Input current of remote control pin	Nominal Vin		-0.5mA ~ +0.5mA
Remote off state input current	Nominal Vin		2.5mA

ENVIRONMENTAL SPECIFICATIONS			
Operating ambient temperature			-40°C ~ +66°C (without derating)
			+66°C ~ +105°C (with derating)
Maximum case temperature			105°C
Storage temperature range			-55°C ~ +125°C
Thermal impedance (Note 7)		Nature convection	12°C/Watt
		Nature convection with heat-sink	10°C/Watt
Thermal shock			MIL-STD-810F
Vibration			MIL-STD-810F
Relative humidity			5% to 95% RH

EMC CHARACTERISTICS			
EMI (Note 8)	EN55022		Class A
ESD	EN61000-4-2	Air	± 8KV
		Contact	± 6KV
Radiated immunity	EN61000-4-3	10 V/m	Perf. Criteria A
Fast transient (Note 9)	EN61000-4-4	± 2KV	Perf. Criteria B
Surge (Note 9)	EN61000-4-5	± 1KV	Perf. Criteria A
Conducted immunity	EN61000-4-6	10 Vr.m.s	Perf. Criteria A

Model Number	Input Range	Output Voltage	Output Current		Output <sup>(4)</sup> Ripple & Noise	Input Current		Eff <sup>(4)</sup> (%)	Capacitor <sup>(5)</sup> Load max
			Min. load	Full load		No Load <sup>(3)</sup>	Full Load <sup>(2)</sup>		
MT20E-2433SI-W	9 – 36 VDC	3.3 VDC	0mA	5500mA	60mVp-p	50mA	934mA	85	18000 $\mu$ F
MT20E-2405SI-W	9 – 36 VDC	5 VDC	0mA	4000mA	75mVp-p	65mA	992mA	88	9600 $\mu$ F
MT20E-2412SI-W	9 – 36 VDC	12 VDC	0mA	1670mA	75mVp-p	22mA	1018mA	86	1650 $\mu$ F
MT20E-2415SI-W	9 – 36 VDC	15 VDC	0mA	1330mA	75mVp-p	22mA	1014mA	86	1050 $\mu$ F
MT20E-2405WI-W	9 – 36 VDC	$\pm$ 5 VDC	0mA	$\pm$ 2000mA	100mVp-p	55mA	992mA	88	$\pm$ 4800 $\mu$ F
MT20E-2412WI-W	9 – 36 VDC	$\pm$ 12 VDC	0mA	$\pm$ 833mA	100mVp-p	30mA	1004mA	87	$\pm$ 825 $\mu$ F
MT20E-2415WI-W	9 – 36 VDC	$\pm$ 15 VDC	0mA	$\pm$ 667mA	100mVp-p	30mA	1005mA	87	$\pm$ 525 $\mu$ F
MT20E-4833SI-W	18 – 75 VDC	3.3 VDC	0mA	5500mA	60mVp-p	35mA	467mA	85	18000 $\mu$ F
MT20E-4805SI-W	18 – 75 VDC	5 VDC	0mA	4000mA	75mVp-p	35mA	496mA	88	9600 $\mu$ F
MT20E-4812SI-W	18 – 75 VDC	12 VDC	0mA	1670mA	75mVp-p	15mA	503mA	87	1650 $\mu$ F
MT20E-4815SI-W	18 – 75 VDC	15 VDC	0mA	1330mA	75mVp-p	15mA	501mA	87	1050 $\mu$ F
MT20E-4805WI-W	18 – 75 VDC	$\pm$ 5 VDC	0mA	$\pm$ 2000mA	100mVp-p	35mA	490mA	89	$\pm$ 4800 $\mu$ F
MT20E-4812WI-W	18 – 75 VDC	$\pm$ 12 VDC	0mA	$\pm$ 833mA	100mVp-p	17mA	496mA	88	$\pm$ 825 $\mu$ F
MT20E-4815WI-W	18 – 75 VDC	$\pm$ 15 VDC	0mA	$\pm$ 667mA	100mVp-p	17mA	496mA	88	$\pm$ 525 $\mu$ F

Note:

1. BELLCORE TR-NWT-000332. Case 1: 50% Stress, Temperature at 40°C.  
MIL-HDBK-217F Notice2 @Ta=25 °C, Full load(Ground, Benign, controlled environment)
2. Maximum value at nominal input voltage and full load.
3. Typical value at nominal input voltage and no load.
4. Typical value at nominal input voltage and full load.
5. Test by minimum Vin and constant resistive load.
6. The ON/OFF control pin voltage is referenced to -Vin.  
To order negative logic ON/OFF control add the suffix-N (Ex: MT20E-4805SI-W-N)
7. Heat sink is optional and P/N: 7G-0020C-F.
8. The MT20E-W series can meet EN55022 Class A with parallel an external capacitor to the input pins.  
Recommend : 24Vin : NA.  
48Vin : 1 $\mu$ F/100V 1210 MLCC.
9. An external input filter capacitor is required if the module has to meet EN61000-4-4, EN61000-4-5.  
The filter capacitor Kaga USA suggest: Nippon chemi-con KY series, 220 $\mu$ F/100V, ESR 48m $\Omega$ .

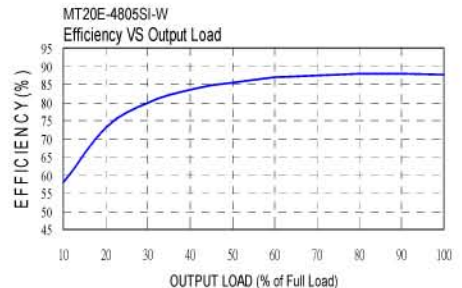
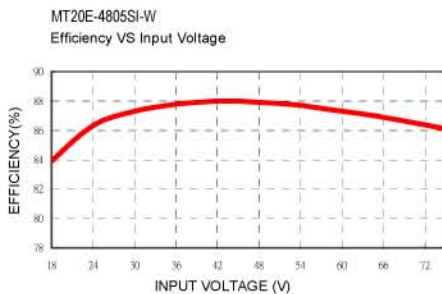
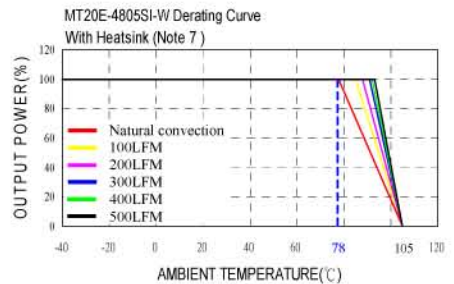
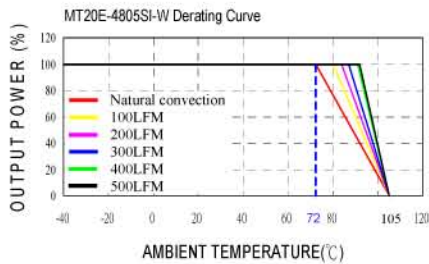

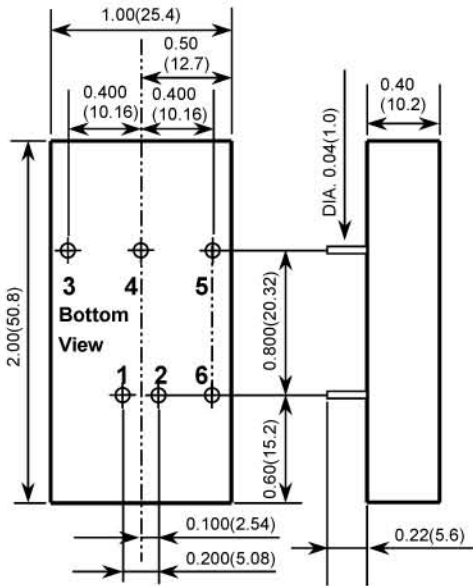

- All dimensions in Inches (mm)  
Tolerance: X.XX±0.02 (X.X±0.5)  
X.XXX±0.01 (X.XX±0.25)
- Pin pitch tolerance ±0.01(0.25)
- Pin dimension tolerance ±0.004 (0.1)

### PIN CONNECTION

PIN	SINGLE	DUAL
1	+ INPUT	+ INPUT
2	- INPUT	- INPUT
3	+ OUTPUT	+ OUTPUT
4	TRIM	COMMON
5	- OUTPUT	- OUTPUT
6	CTRL	CTRL

### EXTERNAL OUTPUT TRIMMING

Output can be externally trimmed by using the method shown below.

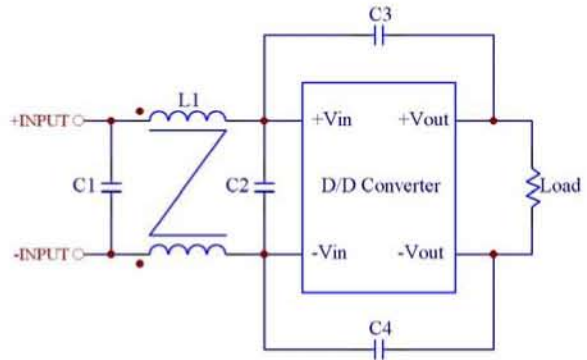
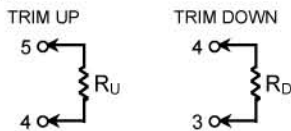

### Recommended Filter for EN55022 Class B Compliance

The components used in the above figure, together with the manufacturers' part numbers for these components, are as follows:

	C1	C2	C3	C4	L1
MT20E-24xxx-W	4.7µF/50V 1812 MLCC	N/A	1000pF/2KV MLCC	1000pF/2KV MLCC	450µH Common Choke PMT-048
MT20E-48xxx-W	2.2µF/100V 1812 MLCC	2.2µF/100V 1812 MLCC	1000pF/2KV MLCC	1000pF/2KV MLCC	325µH Common Choke PMT-050