

LC 8 PORT ADAPTER P/N	ADAPTER COLOR	SPLIT SLEEVE MATERIAL
106121-0450	BLUE	CERAMIC
106121-0460	GREEN	
106121-0470	BEIGE	PHOSPHOR BRONZE
106121-0480	AQUA	

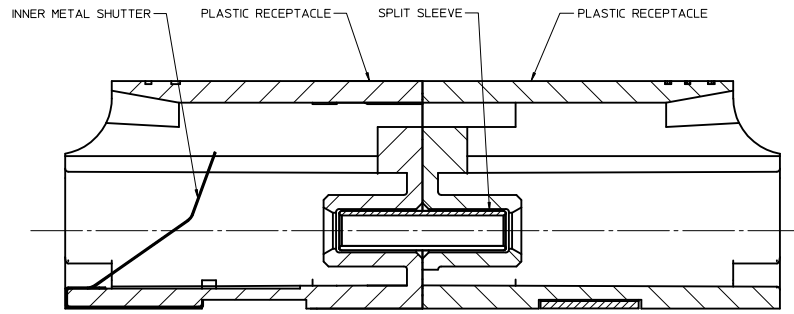

SECTION Z-Z
Scale 10:1

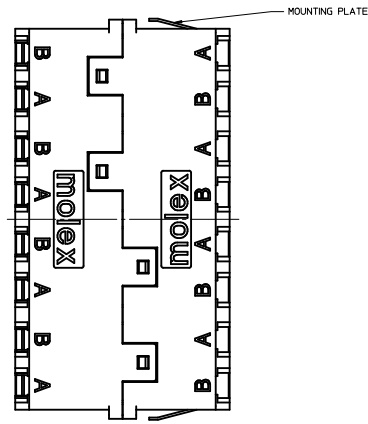
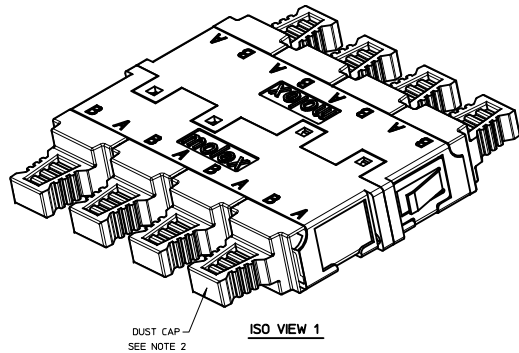
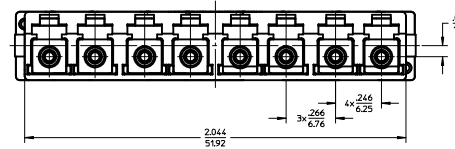
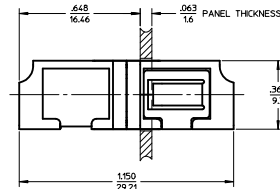
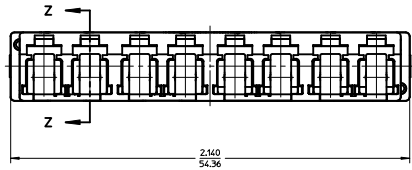

ISO VIEW 1
DUST CAP - SEE NOTE 2

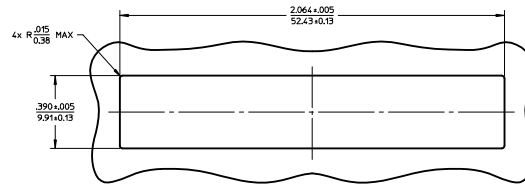

RECOMMENDED MOUNTING PATTERN

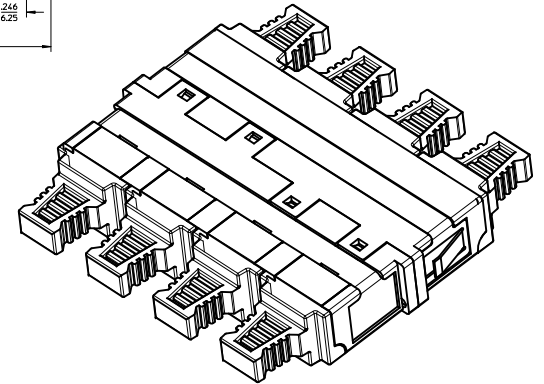

ISO VIEW 2

NOTES:
1. ALL DIMENSIONS ARE FOR REFERENCE.
2. DUST CAPS SHOWN IN ISO VIEWS ONLY.

ENTER DESCRIPTION IEC NO. MF2012-0092 DRAWN/YBELNKIY 2012/01/04 CHKD: APPR:WCHEN 2012/02/06 REV:	QUALITY SYMBOLS	GENERAL TOLERANCES (UNLESS SPECIFIED)	DIMENSION STYLE IN/MM	SCALE 3:1	DESIGN UNITS INCH	THIRD ANGLE PROJECTION	
		4 PLACES ± --- ± --- 3 PLACES ± --- ± --- 2 PLACES ± --- ± --- 1 PLACE ± --- ± ---	mm INCH	DRAWN BY YBELNKIY	DATE 2012/01/04	TITLE LC 8 PORT ADAPTER SNAP MOUNT INNER SHUTTERS	
		ANGULAR ± ---°	DRAFT WHERE APPLICABLE MUST REMAIN WITHIN DIMENSIONS	APPROVED BY WCHEN	DATE 2012/02/06	MATERIAL NO. SEE TABLE	DOCUMENT NO. SD-106121-0450
				SIZE D	MOLEX INCORPORATED SHEET NO. 1 OF 1		