

5

4

3

2

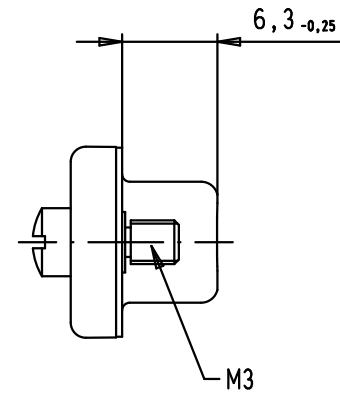
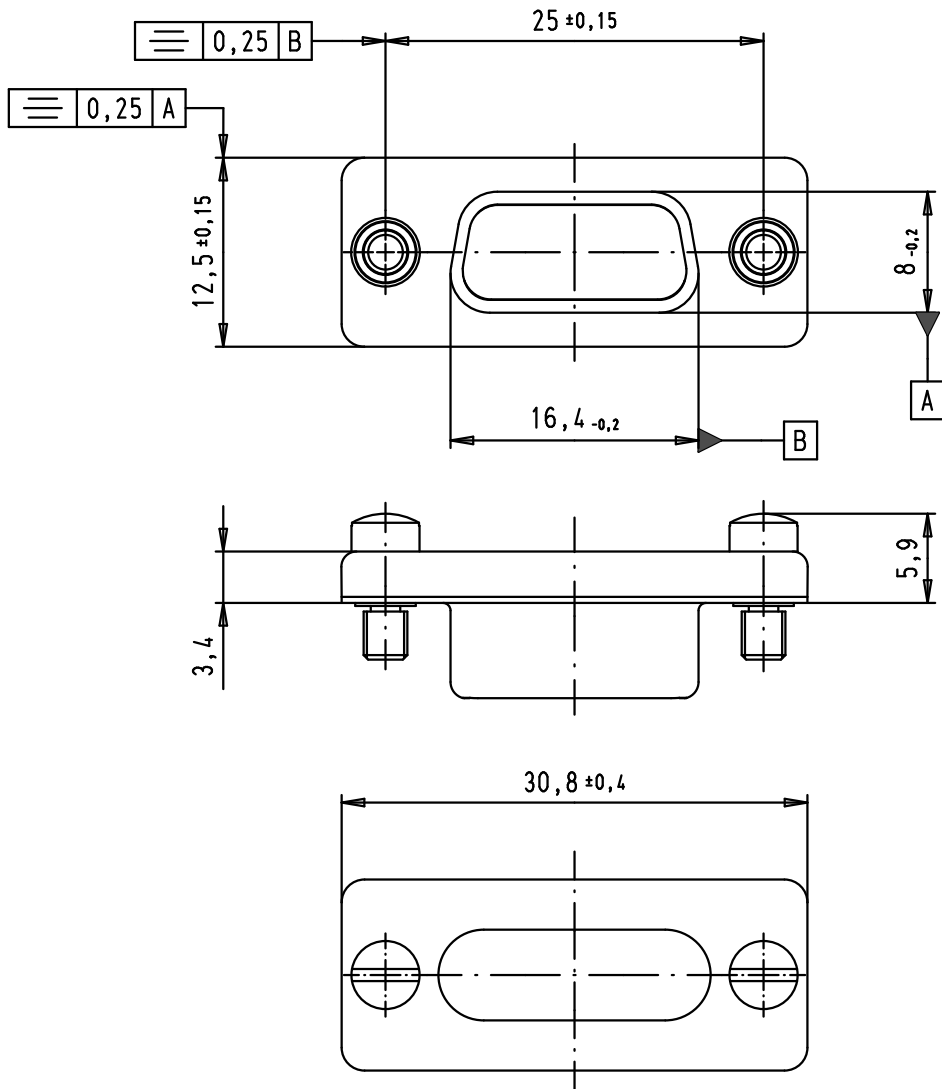

1

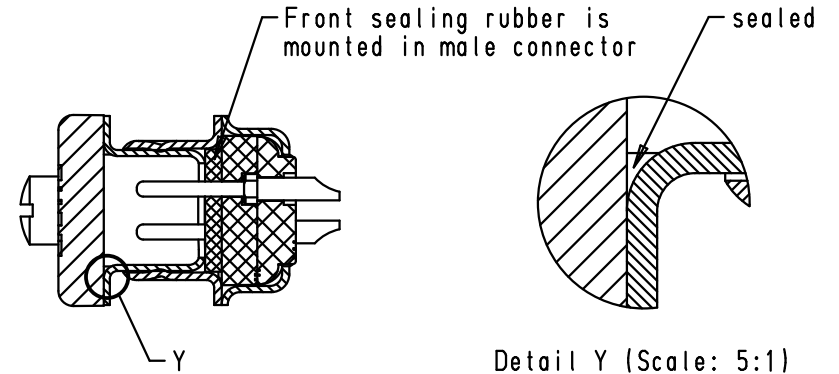

IP 67 shielding concept

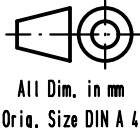

Front sealing rubber 09 67 002 9001 must be purchased separately

			Dot.	Name	 <p>All Dim. in mm Orig. Size DIN A 4</p>	IP 67 female metal shielding cap, tin plated shell for 9 poles male D-Sub with screw locks	Maßstab/ Scale	
			Detail.	12/04/07			PK	2:1
			Insp.					
			Stand.					
34906	18/04/08	PK	HARTING EURL F-95972 Paris				TB 09 67 002 9065	Blatt/ Page
33977	12/04/07	PK						1 / 1
Mod.	Dot.	Name						Sub.

D

C

B

A