

STRADELLA-HB-S

~25° spot beam for industrial applications

TECHNICAL SPECIFICATIONS:

Dimensions	13.9 mm
Height	7.5 mm
Fastening	pin
Colour	clear
Box size	480 x 250 x 390 mm
Box weight	9 kg
Quantity in Box	16000 pcs
ROHS compliant	yes ⓘ



MATERIAL SPECIFICATIONS:

Component	Type	Material	Colour
STRADELLA-HB-S	Lens array	PMMA	clear

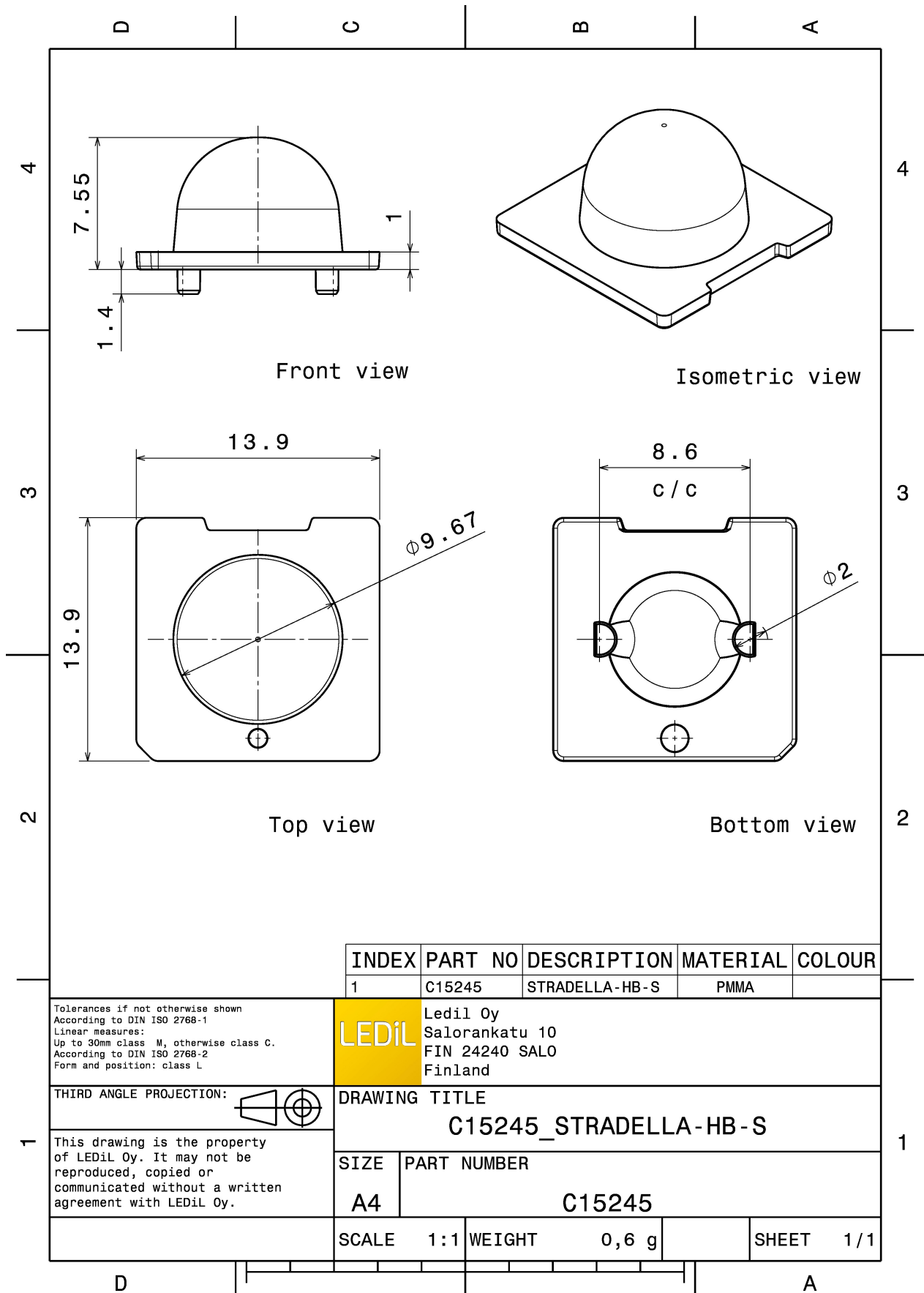

INDEX	PART NO	DESCRIPTION	MATERIAL	COLOUR
1	C15245	STRADELLA-HB-S	PMMA	

Tolerances if not otherwise shown
According to DIN ISO 2768-1
Linear measures:
Up to 30mm class M, otherwise class C.
According to DIN ISO 2768-2
Form and position: class L

LEDiL

Ledil Oy
Salorankatu 10
FIN 24240 SALO
Finland

THIRD ANGLE PROJECTION: 

DRAWING TITLE

C15245_STRADELLA-HB-S

This drawing is the property of LEDiL Oy. It may not be reproduced, copied or communicated without a written agreement with LEDiL Oy.

SIZE PART NUMBER

A4

C15245

SCALE 1:1 WEIGHT 0,6 g SHEET 1/1

PHOTOMETRIC DATA (MEASURED):

CREE 

LED XT-E
FWHM 27.0°
Efficiency 92 %
Peak intensity 1.550 cd/lm
Required components:

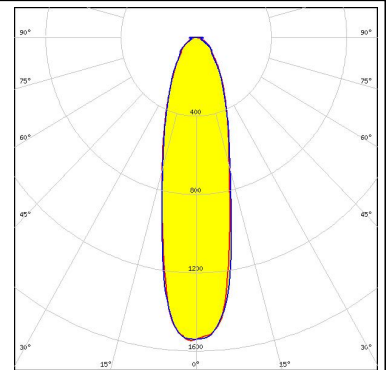
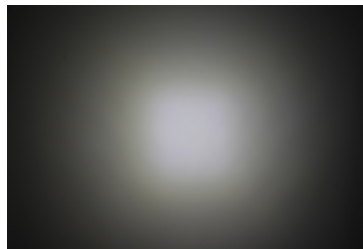

NICHIA 

LED NVSW219D
FWHM 32.0°
Efficiency 94 %
Peak intensity 1.700 cd/lm
Required components:

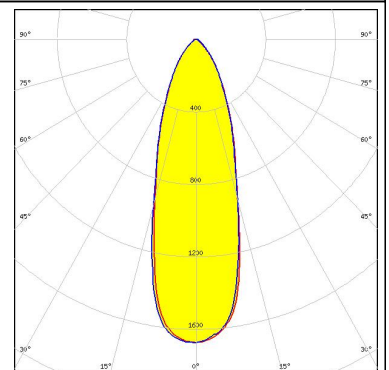
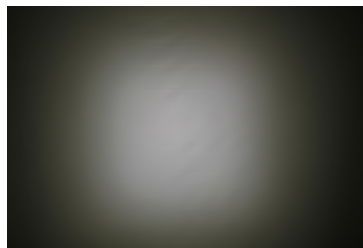

SAMSUNG

LED LH181B
FWHM 23.0°
Efficiency 94 %
Peak intensity 2.200 cd/lm
Required components:

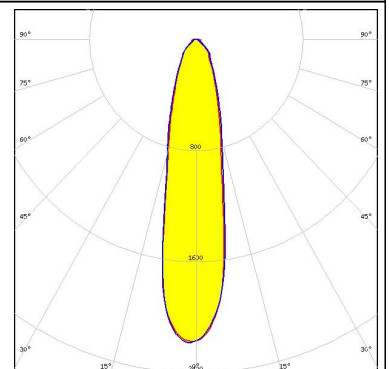

PHOTOMETRIC DATA (SIMULATED):

LUMILEDS

LED LUXEON IR Domed 150
FWHM 23.0°
Efficiency 92 %
Peak intensity 0.000 cd/lm
Required components:

NICHIA

LED NVSxx19B/NVSxx19C
FWHM 31.0°
Efficiency 93 %
Peak intensity 1.600 cd/lm
Required components:

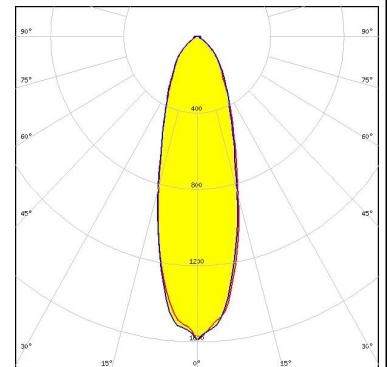

OSRAM

Opto Semiconductors
LED OSCONIQ P 3737 (2W version)
FWHM 27.0°
Efficiency 94 %
Peak intensity 2.000 cd/lm
Required components:

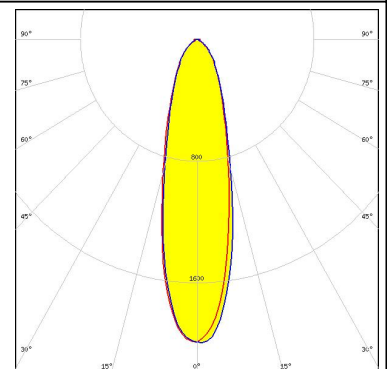

SAMSUNG

LED LH351B
FWHM 32.0°
Efficiency 90 %
Peak intensity 1.650 cd/lm
Required components:

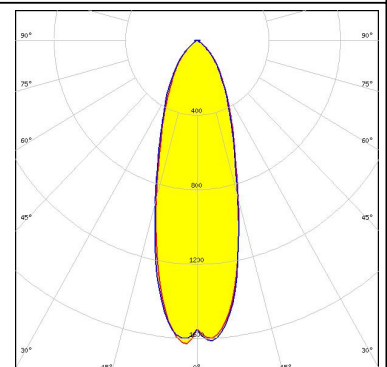

PHOTOMETRIC DATA (SIMULATED):

SAMSUNG

LED LM28xB Series
FWHM 28.0°
Efficiency 94 %
Peak intensity 1.920 cd/lm
Required components:

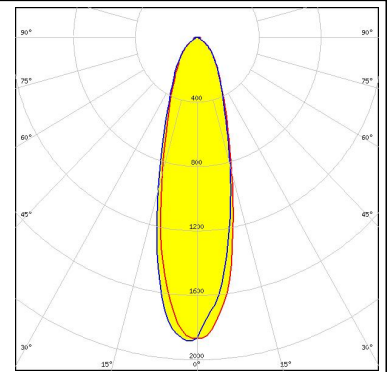

SEOUL SEMICONDUCTOR

LED Z5M1/Z5M2
FWHM 27.0°
Efficiency 94 %
Peak intensity 2.000 cd/lm
Required components:

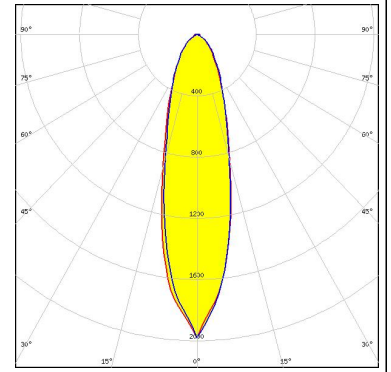

GENERAL INFORMATION:

NOTE: The typical beam angle will be changed by different color, chip size and chip position tolerance. The typical total beam angle is the full angle measured where the luminous intensity is half of the peak value.

MATERIALS:

As part of our continuous research and improvement processes, and to ensure the best possible quality and availability of our products, LEDiL reserves the right to change material grades without notice.

PRODUCT DATA USER AGREEMENT AND DISCLAIMER:

The measured data in the provided downloadable LEDiL Product Datasheets and Mechanical 2D-Drawings is rounded and provided as reference for planning. LEDiL Oy's optical specifications have been verified by conducting performance testing of the products in accordance with the company's quality system. The reported data are averaged results of multiple measurements with typical variation. LEDiL Oy reserves the right to without prior notification make changes and improvements to its products.

LEDiL Oy assumes neither warranty, nor guarantee nor any other liability of any kind for the contents and correctness of the provided data. The provided data has been generated with highest diligence but the provided data may in reality not represent the complete possible variation range of all intrinsic parameters. Therefore, in certain cases a deviation from the provided data could occur.

LEDiL Oy reserves the right to undertake technical changes of its products without further notification which could lead to changes in the provided data. LEDiL Oy assumes no liability of any kind for the possible deviation from any provided data or any other damage resulting from the usage of the provided data.

The user agrees to this disclaimer and user agreement with the download or usage of the provided files.

LEDiL Oy

Joensuunkatu 13
FI-24240 SALO
Finland

LEDiL Inc.

228 West Page Street
Suite D
Sycamore IL 60178
USA

Local sales and technical support

[www.ledil.com/
where_to_buy](http://www.ledil.com/where_to_buy)

Shipping locations

Salo, Finland
Hong Kong, China

Distribution Partners

[www.ledil.com/
where_to_buy](http://www.ledil.com/where_to_buy)