

ESD Suppressor

Type: **EZAEG**

EZAEG1N, 2N

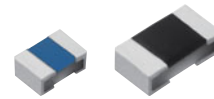

Features

- Good ESD withstanding (IEC61000-4-2 15 kV contact/air Discharge)
- ESD protection of high-speed data lines
- Low capacitance 0.04 pF : 0603(0201) size
0.05 pF : 1005(0402) size
- Good ESD suppression characteristics
- RoHS compliant

Recommended Applications

- Smart phones, Mobile phones, RF Modules, NFC and GPS
- ESD suppression of high-speed differential data line such as Antena circuit, HDMI, SATA, USB, Display Port

Explanation of Part Numbers

1	2	3	4	5	6	7	8	9	10	11	
E	Z	A	E	G	2	N	5	0	A	X	
Product Code ESD Suppressor		Size Code Size mm (inch)		Design Specification Code Design Specification		Peak Voltage Code Peak Voltage		Special Feature Code Special Feature		Packaging Methods Code Packaging Part No.	
		1 0603 (0201)	N ESD withstanding 15 kV Rated Voltage 30 V		50	500 V	A	Standard	C	Pressed Carrier Taping 2 mm Pitch, 15,000 pcs.	EZAEG1N
		2 1005 (0402)							X	Pressed Carrier Taping 2 mm Pitch, 10,000 pcs.	EZAEG2N

Construction

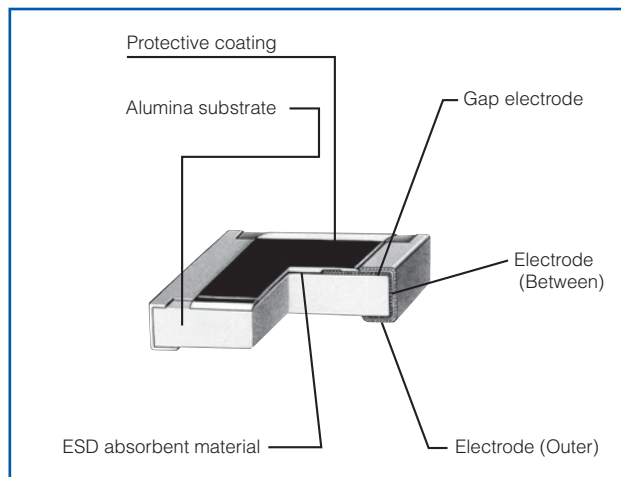

Dimensions in mm (not to scale)

Part No. (inch size)	Dimensions (mm)					Mass (Weight) [g/1000 pcs.]
	L	W	a	b	t	
EZAEG1N (0201)	0.60±0.03	0.30±0.03	0.15±0.10	0.15±0.10	0.23±0.03	0.12
EZAEG2N (0402)	1.00±0.10	0.50±0.05	0.20±0.10	0.27±0.10	0.38±0.05	0.60

Circuit Configuration

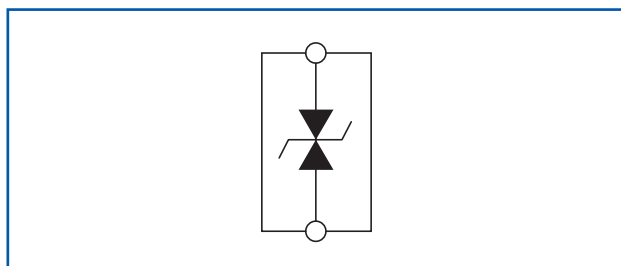

Ratings

Part Number (inch size)	Capacitance ⁽¹⁾	Peak Voltage ⁽²⁾	Clamping Voltage ⁽³⁾	ESD withstanding ⁽⁴⁾	Rated Voltage	Category Temperature Range
EZAEG1N50AC (0201)	0.04 ^{+0.04} _{-0.03} pF	500 V max. (350 V typ.)	100 V max.	Contact/Air 15 kV	30 V max	-55 to +125 °C
EZAEG2N50AX (0402)	0.05 ^{+0.05} _{-0.04} pF					

(1) Capacitance = The capacitance value shall be measured under the conditions specified below.

Frequency : 1 MHz±10 %, Voltage : 1 Vrms±0.2 Vrms, Temperature : 25 °C±2 °C

(2) Peak Voltage = The peak voltage value shall be measured under the following conditions. ESD test conditions : IEC61000-4-2, 8 kV contact discharge

(3) Clamping Voltage = The clamping voltage value shall be measured at 30 ns after initiation of pulse and measured under the conditions specified below.
ESD test conditions : IEC61000-4-2, 8 kV contact discharge

(4) ESD test conditions : IEC61000-4-2 contact discharge

Frequency Characteristics

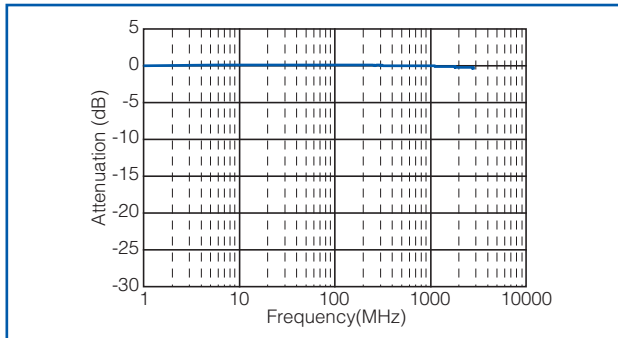

ESD Suppression Voltage Waveform

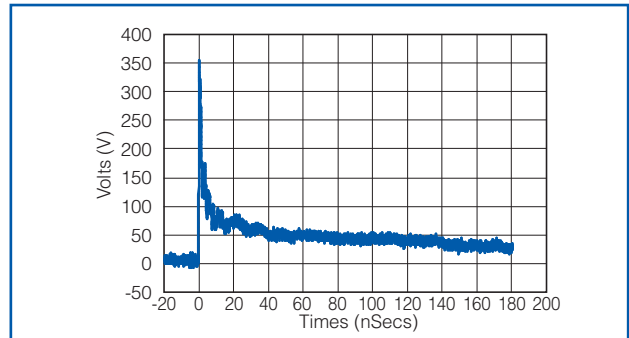

Typical Circuits Requiring Protection

● HDMI circuit

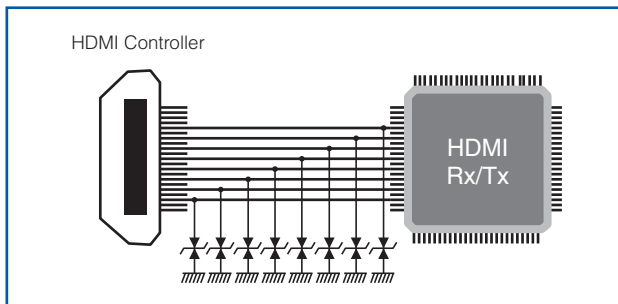

● Antenna circuit

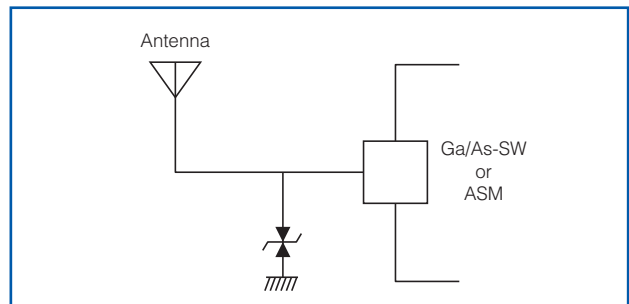

Recommended Land Pattern

Recommended land pattern design for ESD Suppressor is shown below.

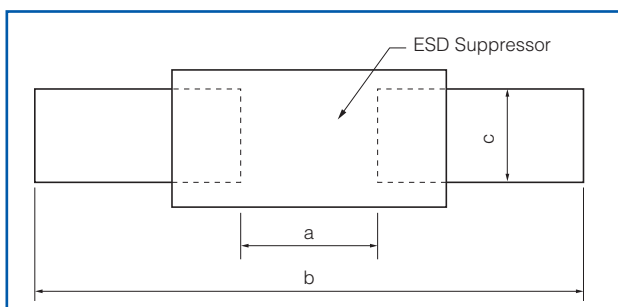

Part Number (inch size)	Dimensions (mm)		
	a	b	c
EZAEG1N (0201)	0.3 to 0.4	0.8 to 0.9	0.25 to 0.35
EZAEG2N (0402)	0.5 to 0.6	1.4 to 1.6	0.40 to 0.60

■ As for Packaging Methods, Soldering Conditions and Safety Precautions,

Please see Data Files