

## INSIDE.....

**\* 23 NEW  
PRODUCTS  
RELEASED!**

### Product Showcase

#### High Gain, 1 Watt PA



HMC457QS16G

- 1700 - 2200 MHz
- 26 dB Gain
- +45 dBm Output IP3
- Single +5V Supply

See Page 3

#### 1 Watt WiMAX PA



HMC409LP4

- 3.3 - 3.8 GHz
- 31 dB Gain
- +46 dBm Output IP3
- Integrated Power Down Control

See Page 3

#### LNA / Driver Amp



HMC516

- 7 - 17 GHz
- 21 dB Gain
- +15 dBm P1dB
- 1.8 dB Noise Figure

See Page 4

## HITTITE INTRODUCES CONNECTORIZED MODULE PRODUCT LINE!

### Wideband Low Noise, Driver & Power Amps Cover DC to 20 GHz

Hittite Microwave announces the introduction of the first product within the company's new Connectorized Module Product Line. The HMC-C001 GaAs PHEMT Wideband Low Noise Amplifier hermetic packaged module is ideal for Military EW/ECM, Space, Test Equipment, Wideband Telecom, Microwave Radio and Industrial applications from 2 to 20 GHz.

(Continued on page 6)



## SERIALLY CONTROLLED DIGITAL ATTENUATORS NOW AVAILABLE

### Wideband Digital Attenuators Offer a Simplified Control Interface

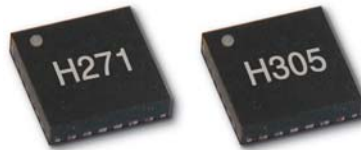

Hittite Microwave announces the release of two new GaAs MMIC Digital Attenuators which incorporate a TTL/CMOS compatible serial control interface with the outstanding high frequency performance of a MESFET based digital attenuator. The HMC271LP4 and HMC305LP4 5-Bit Digital Attenuators are ideal for wireless infrastructure, test equipment, microwave radio and military applications from 0.7 to 3.8 GHz. These positive bias products complement Hittite's broad line of digital and voltage-variable attenuators which are in use worldwide, providing frequency coverage up to 20 GHz.

(Continued on page 6)

## HITTITE RELOCATES OPERATIONS!

### Expands to New Location in Chelmsford, Massachusetts

Hittite Microwave Corporation has relocated operations to a larger facility at 20 Alpha Road in Chelmsford, Massachusetts. The new 72,000 square foot (6,689 m<sup>2</sup>) facility is more than double the size of the previous location, providing added manufacturing and design space including room for future expansion.

Over 31,000 square feet (2,880 m<sup>2</sup>) is dedicated to engineering evaluation, quality/reliability, production control/assembly/test including a 6,200 square foot (575 m<sup>2</sup>) Class 100K clean room. The large clean room accommodates new Class 100 work areas for MMIC die inspection/test as well as the expansion of hybrid MIC module assembly operations for space and military products. A new production test area provides ample room for additional test handlers, expanding Hittite's high volume RF test capacity for plastic/ceramic packaged products. An environmental test lab provides screening and qualification for die, packaged die and microwave modules/sub-assemblies.

With a new facility, expanded capacity and continued dedication to customer satisfaction and support, Hittite is ready to meet the needs of RF & Microwave System OEMs.



## HMC450QS16G

### 1/2 Watt High Gain Medium Power Amplifier, 800 - 1000 MHz



#### Features

- Gain: 26 dB
- Saturated Power: +28.5 dBm
- +40 dBm Output IP3
- Integrated Power Control (Vpd)
- Single +5V Supply

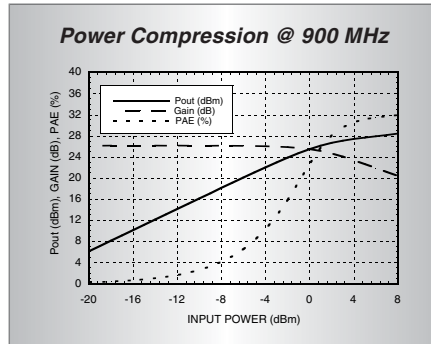

#### Ideal Cellular BTS Driver

The HMC450QS16G is a high gain GaAs InGaP HBT Medium Power MMIC amplifier operating 800 to 1000 MHz. The amplifier is packaged in a low cost, 16 lead SMT package and offers the same pinout and functionality as the higher band HMC413QS16G 1.6 – 2.3 GHz PA. With a minimum of external components, the amplifier provides 26 dB of gain, +40 dBm OIP3 and +28.5 dBm of saturated power from a +5.0V supply. The integrated power control (Vpd) can be used for full power down or RF output power/current control.

## HMC452ST89

### 1 Watt Linear Power Amplifier, 400 - 2200 MHz



#### Features

- Output IP3: +49 dBm
- 16 dB Gain @ 900 MHz
- 10 dB Gain @ 2100 MHz
- 45% PAE @ +31 dBm Pout
- +25 dBm CDMA2000 Channel Power @ -45 dBc ACP

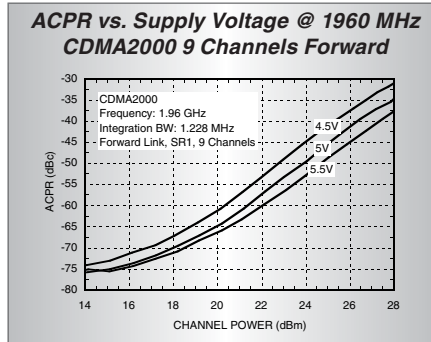

#### Combines Efficient Power & Linearity

The HMC452ST89 is a high dynamic range GaAs InGaP HBT 1 Watt MMIC power amplifier operating 400 - 2200 MHz. Packaged in a low cost industry standard SOT89 package, the amplifier gain is typically 10 dB from 1.7 to 2.2 GHz. Utilizing a minimum number of external components and a single +5V supply, the amplifier output IP3 can be optimized to +49 dBm from 1.8 - 2.2 GHz. The high output IP3 and PAE makes the HMC452ST89 an ideal power amplifier for Cellular/PCS/3G and Fixed Wireless applications.

## HMC453ST89

### 1.6 Watt Linear Power Amplifier, 400 - 2200 MHz



#### Features

- Output IP3: +50 dBm
- 15 dB Gain @ 900 MHz
- 9 dB Gain @ 2100 MHz
- 40% PAE @ +32.5 dBm Pout
- +26 dBm CDMA2000 Channel Power @ -45 dBc ACP

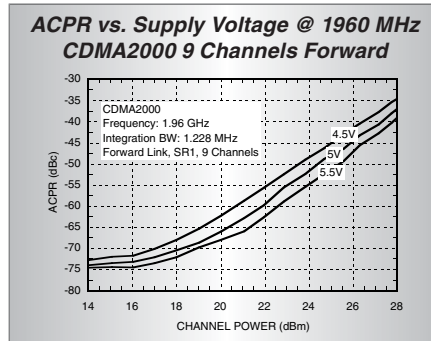

#### Excellent Linearity & Power

The HMC453ST89 is a high dynamic range GaAs InGaP HBT 1.6 Watt MMIC power amplifier operating 400 - 2200 MHz. Packaged in a low cost industry standard SOT89 package, the amplifier gain is typically 9 dB from 1.7 to 2.2 GHz. Utilizing a minimum number of external components and a single +5V supply, the amplifier output IP3 can be optimized to +50 dBm from 1.8 - 2.2 GHz. The high output IP3 and PAE makes the HMC453ST89 an ideal power amplifier for Cellular/PCS/3G and Fixed Wireless applications.

## HMC457QS16G

### 1 Watt High Gain Linear Power Amplifier, 1700 - 2200 MHz



#### Features

- Output IP3: +45 dBm
- Gain: 26 dB
- 48% PAE @ +32 dBm Pout
- +25.5 dBm CDMA2000 Channel Power @ -45 dBc ACP
- Single +5V Supply

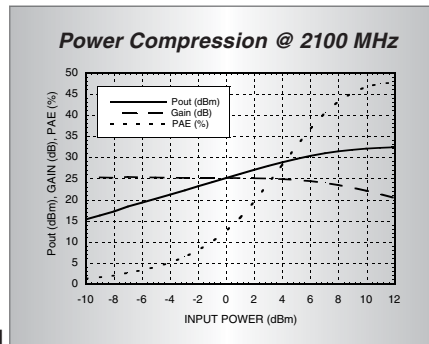

#### Integrated Power Control (Vpd)

The HMC457QS16G is a high dynamic range GaAs InGaP HBT Medium Power MMIC amplifier operating 1700 to 2200 MHz. Packaged in a miniature 16 lead QSOP plastic package, the amplifier gain is typically 27 dB from 1.7 to 2.0 GHz and 25 dB from 2.0 to 2.2 GHz. Utilizing a minimum number of external components, the amplifier output IP3 can be optimized to +45 dBm at 1.9 GHz or +44 dBm at 2.1 GHz. The power control (Vpd) can be used for full power down or RF output power/current control.

## HMC409LP4

### 1 Watt High Gain Linear Power Amplifier, 3.3 - 3.8 GHz



#### Features

- Gain: 31 dB
- 40% PAE @ +32.5 dBm Pout
- +46 dBm Output IP3
- Integrated Power Control (VPD)
- Single +5V Supply

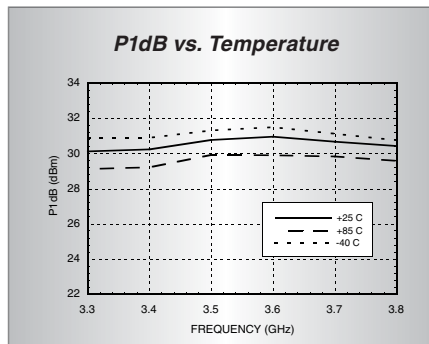

#### Ideal for WiMAX Applications

The HMC409LP4 is a high efficiency GaAs InGaP HBT MMIC Power amplifier operating between 3.3 to 3.8 GHz. The amplifier is packaged in a low cost, leadless SMT package. Utilizing a minimum of external components the amplifier provides 31 dB of gain and +32.5 dBm of saturated power from a +5.0V supply voltage. The power control (Vpd) can be used for full power down or RF output power/current control. The HMC409LP4 combines high gain and linearity to help WiMAX OEMs meet 802.16 requirements.

## HMC500LP3

### GaAs HBT Vector Modulator RFIC, 1800 - 2200 MHz

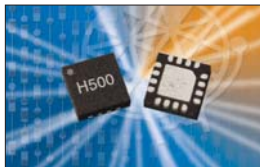

#### Features

- 360° of Continuous Phase Control
- 40 dB of Continuous Gain Control
- 162 dBm/Hz Output Noise Floor
- 3 x 3 mm QFN Plastic Package

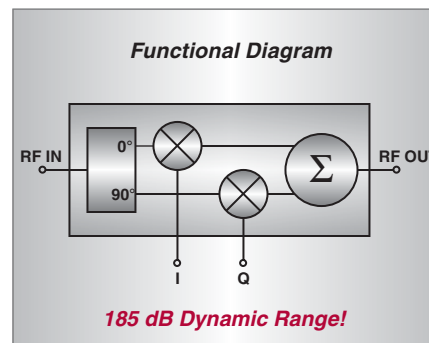

#### Simplifies PA Error Correction

The HMC500LP3 high dynamic range Vector Modulator RFIC is targeted for distortion cancellation applications such as RF predistortion and feed-forward, as well as RF cancellation and beam forming amplitude/phase correction applications. The differential I & Q ports of the HMC500LP3 can be used to continuously vary the phase and amplitude of a RF signal by up to 360 degrees and 40 dB respectively, while supporting a 3 dB modulation bandwidth of 150 MHz. The HMC500LP3 delivers +33 dBm of input IP3 and an output noise floor of -162 dBm/Hz which remains constant across the entire gain control range.

## HMC516 / 517 / 518 / 519

### Low Noise Amplifier Family Covers 7 - 32 GHz



#### Features

- Excellent Microwave Radio Coverage
- Combine Low NF & High IP3
- Single +3V Supply
- SMT Packaged Products Starting December 2004

	HMC516	HMC517	HMC518	HMC519
Frequency (GHz)	7 - 17	17 - 28	20 - 32	18 - 32
Gain (dB)	21	20	14	15
NF (dB)	1.8	2.0	2.8	2.6
P1dB (dBm)	+15	+11	+12	+12
OIP3 (dBm)	+20	+23	+24	+22

#### Versatile as LNAs or Drivers

This new family of GaAs PHEMT MMIC Low Noise Amplifier Die was designed to meet the needs of microwave radio designers who want a low noise front end device that can also provide enough output power to drive a mixer LO or function as general purpose buffer amp. These LNAs achieve noise figures as low as 1.8 dB while providing up to 21 dB gain and +17 dBm Psat. The chips can easily be integrated into hybrid or MCM assemblies due to their small size and standard I/O pinout.

## HMC498LC4

### +26 dBm Medium Power SMT Amplifier, 17 - 24 GHz



#### Features

- +36 dBm Output IP3
- +26 dBm @ 23% PAE
- 22 dB Gain
- +5V @ 250 mA Supply
- RoHS Compliant
- 4 x 4 mm Package

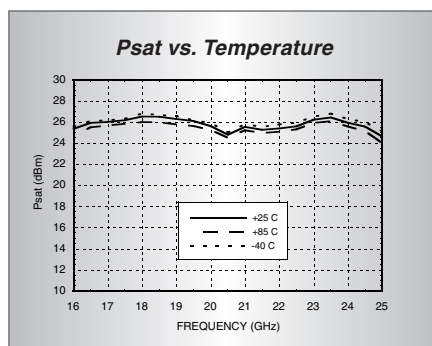

#### Combines High Gain & Linearity

The HMC498LC4 is a high dynamic range GaAs PHEMT MMIC Medium Power Amplifier housed in a leadless "Pb free" SMT package. Operating 17 to 24 GHz, the amplifier provides 22 dB of gain, +26 dBm of saturated power and 23% PAE. Noise figure is 4 dB while output IP3 is +36 dBm enabling the HMC498LC4 to function as a low noise front end as well as a driver amplifier. The RF I/Os are DC blocked and matched to 50 Ohms for ease of use. Utilizing the HMC498LC4 eliminates the need for wire bonding, thereby providing a consistent connection interface for the millimeterwave circuit designer.

## HMC499LC4

### +25 dBm Medium Power SMT Amplifier, 21 - 32 GHz



#### Features

- +33 dBm Output IP3
- +25 dBm @ 16% PAE
- 15 dB Gain
- +5V @ 200 mA Supply
- RoHS Compliant
- 4 x 4 mm Package

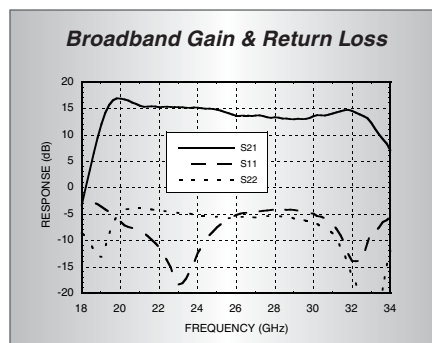

#### Efficient mmWave Power

The HMC499LC4 is a high dynamic range GaAs PHEMT MMIC Medium Power Amplifier housed in a leadless "Pb free" SMT package. Operating 21 to 32 GHz, the amplifier provides 15 dB of gain, +25 dBm of saturated power and 16% PAE. P1dB output is +24 dBm while output IP3 is +33 dBm making the HMC499LC4 an excellent choice as a driver amplifier. The RF I/Os are DC blocked and matched to 50 Ohms for ease of use. Utilizing the HMC499LC4 eliminates the need for wire bonding, thereby providing a consistent connection interface for the millimeterwave circuit designer.

**HMC144LC4**

**High IP3 Double-Balanced SMT Passive Mixer, 5 - 20 GHz**



**Features**

- 30 dB LO/RF Isolation
- High IP3: +21 dBm
- No External Components Required
- RoHS Compliant
- 4 x 4 mm Package

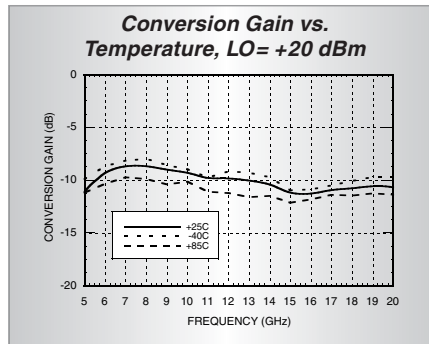

**Wideband Performance!**

The HMC144LC4 is a Double-Balanced MMIC Mixer in a leadless "Pb free" SMT package which can be used as an up or downconverter from 5 to 20 GHz. Broad-band operation and 30 to 40 dB isolations are provided by on-chip baluns, which require no external components or DC bias. The inherent IC design & fabrication make MMIC mixers more reliable replacements to hybrid diode mixers as well as assuring consistent performance over high volume production lots. Utilizing the HMC144LC4 eliminates the need for wire bonding, thereby providing a consistent connection interface for the microwave circuit designer.

**HMC264LC3B**

**Sub-Harmonic SMT Mixer w/ 0 dBm LO, 21 - 31 GHz**



**Features**

- 4 to +4 dBm LO Input
- Sub-Harmonically Pumped LO
- High 2LO/RF Isolation: 30 dB
- DC - 6 GHz Wideband IF
- RoHS Compliant
- 3 x 3 mm Package

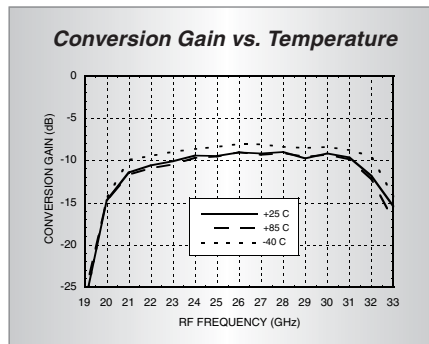

**Integrated LO Driver & Mixer**

The HMC264LC3B is a 21 - 31 GHz Sub-Harmonically Pumped (x2) MMIC Mixer with an integrated LO amplifier in a leadless "Pb Free" SMT package. The 2LO/RF isolation is excellent at 30 dB, eliminating the need for additional filtering. The LO amplifier requires a single +3 to +4V bias & only -4 to +4dBm drive. The RF and LO ports are DC blocked and matched to 50 Ohms for ease of use while the IF covers DC to 6 GHz. Utilizing the HMC264LC3B eliminates the need for wire bonding, thereby providing a consistent connection interface for the millimeterwave circuit designer.

**HMC505LP4 & HMC506LP4**

**Low Phase Noise MMIC VCOs, 6.8 - 8.8 GHz**



**Features**

- High Output Power
- Single +3V Supply
- 4 x 4 mm QFN Plastic Package
- Ideal for Microwave Radio & Sensors

Typical Performance*		
	HMC505LP4	HMC506LP4
Output Freq. Range (GHz)	6.8 - 7.3	7.8 - 8.8
Output Power (dBm)	+11	+14
10 kHz SSB Phase Noise (dBc/Hz)	-82	-80
100 kHz SSB Phase Noise (dBc/Hz)	-104	-103

\* Data is mid-band typical

**No External Components Required**

Introducing two new SMT packaged MMIC VCOs with integrated buffer amplifiers that complement HMC's existing line of monolithic VCOs. The HMC505LP4 covers 6.8 to 7.3 GHz while the HMC506LP4 covers 7.8 to 8.8 GHz and offer +11 and +14 dBm output power respectively. Both operate from a single +3V supply and integrate the varactor, negative resistance circuit, resonator & buffer amplifier on a single HBT MMIC. A standard 4 x 4 mm QFN SMT plastic package houses the ICs. Hittite also offers custom designed MMIC VCOs, PLOs & complete synthesizer modules for specific customer requirements.

## HITTITE INTRODUCES CONNECTORIZED MODULE PRODUCT LINE... (continued from page 1)

The HMC-C001 LNA Module delivers a typical small signal gain of 15 dB and an industry leading gain flatness of  $\pm 0.5$  dB across the entire 2 - 20 GHz operating band. This high dynamic range LNA Module offers a mid-band noise figure of 2.5 dB and an output P1dB of +15 dBm, while its self biased topology consumes only 80 mA from a single +12V supply. The HMC-C001 is fully matched, unconditionally stable, and is integrated with DC voltage regulation, DC overvoltage protection, and DC blocked RF ports for robust operation. Table 1 summarizes the performance of the HMC-C002, HMC-C003, and HMC-C004 Wideband Amplifier Modules which will be released in December 2004. The HMC-C001 is production released and available now.

**Table 1: SMA Connectorized Wideband Amplifier Modules**

Frequency (GHz)	Function	Gain (dB)	OIP3 (dBm)	NF (dB)	P1dB (dBm)	Package	Part Number
2 - 20	Wideband LNA	15	26	2.7	15	C	HMC-C001
2 - 20	Wideband LNA	14	28	2.7	16	C	HMC-C002
2 - 20	Wideband PA	16	30	4	26	C	HMC-C003
DC - 20	Wideband Driver	17	30	2.7	22	C	HMC-C004

Hittite's Module Products utilize a flanged, hermetically sealed, gold plated housing which can be either mechanically fastened or eutectically mounted depending on the customer's application. Removable SMA connectors are provided to allow mating with standard coaxial cable assemblies. They can also be quickly detached for drop-in installation and direct connection of the module's RF input and output pins to a microstrip or coplanar circuit. All of these amplifier modules operate from a single positive supply and incorporate rugged DC power conditioning circuitry including negative voltage generation and bias polarity sequencing.

This new product line utilizes Hittite's standard wideband MMIC amplifier products taking advantage of the company's design, manufacturing and quality knowledge base. The detailed HMC-C001 data sheet is found at [www.hittite.com](http://www.hittite.com) and the product is available from stock.

## SERIALLY CONTROLLED DIGITAL ATTENUATORS NOW AVAILABLE... (continued from page 1)

The HMC271LP4 is a 5-bit Digital Attenuator with a 1 dB LSB and operates from 0.7 to 3.8 GHz with a typical insertion loss of 2.1 dB. The HMC271LP4 can be programmed to provide any attenuation state from 1 to 31 dB, in 1 dB steps with a  $\pm 0.5$  dB accuracy. The HMC305LP4 is a 5-bit Digital Attenuator with a 0.5 dB LSB and covers 0.7 to 3.8 GHz with a typical insertion loss of 1.5 dB. The HMC305LP4 can be programmed to provide any attenuation state from 0.5 dB to 15.5 dB, in 0.5 dB steps with a  $\pm 0.3$  dB accuracy. Table 1 summarizes these new digital attenuators which offer input IP3 of up to +52dBm without the need for an internally generated or externally supplied negative voltage. Each attenuator is fully matched to 50 Ohms at all attenuation levels, requires a single positive voltage supply (Vdd) of +5Vdc and a simplified three wire serial control. Figure 1 illustrates the functionality of each attenuator.

These low cost, high linearity digital attenuators are housed in 4mm x 4mm industry standard QFN leadless surface mount packages, and are readily interchangeable due to their identical PCB footprint and pin assignments. Products are available from stock and data sheets can be found on-line at [www.hittite.com](http://www.hittite.com)

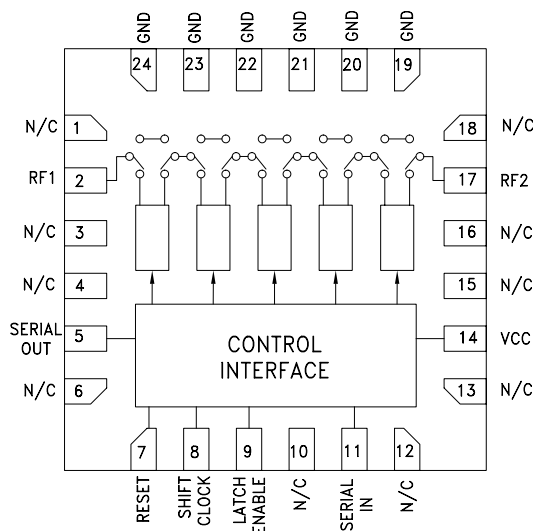

**Figure 1. Functional Diagram of the RF Attenuator & Serial Control Interface**

**Table 1: Serial Control Digital Attenuators**

Frequency (GHz)	Function	Loss (dB)	Atten. Range (dB)	Input IP3 (dBm)	Control Input (Vdc)	Package	Part Number
0.7 - 3.7	5-Bit Digital, Serial Control	2.1	1 to 31	48	Serial TTL/CMOS	LP4	HMC271LP4
0.7 - 3.8	5-Bit Digital, Serial Control	1.5	0.5 to 15.5	52	Serial TTL/CMOS	LP4	HMC305LP4

**HMC482ST89 LINEAR  
GAIN BLOCK OUTPUTS +24dBm!**



Hittite has released the high linearity HMC482ST89 SiGe HBT Gain Block MMIC SMT amplifier covering DC to 5 GHz. Packaged in an

industry standard SOT89, the amplifier can be used as a cascadable 50 Ohm RF/IF gain stage as well as a LO or PA driver with up to +24 dBm output power. The HMC482ST89 offers 19 dB of gain with a +36 dBm output IP3 at 1 GHz while requiring only 110 mA from a single positive supply and a minimal number of external bias components. Data sheets are at [www.hittite.com](http://www.hittite.com)

**HITTITE ADDS NEW REPRESENTATIVES!**

**ASD Technology to Represent HMC in Australia & New Zealand**

ASD Technology Pty Ltd, headquartered in Sydney, Australia is a dynamic, high-tech company offering the world's best products and solutions covering areas of RF/Microwave, Satellite Communication and Fiber Optics. ASD Technology can be contacted via telephone at +61 2 9884 7486, fax at +61 2 8080 8366 or email at [info@asdtech.com.au](mailto:info@asdtech.com.au).

**ACETEC to Represent HMC in Southern California**

ACETEC specializes in RF/Microwave sales to the consumer, industrial, military and space electronics industries. Their offices in San Diego, Tustin and Santa Barbara offer full support to customers in the Southern California area. ACETEC can be contacted via telephone at (858) 784-0900, fax at (858)784-0909 or email at [sales@acetec.com](mailto:sales@acetec.com). Visit their website at [www.acetec.com](http://www.acetec.com).

**AUTUMN 2004  
SELECTION GUIDE NOW AVAILABLE!**

Hittite Microwave is pleased to announce the release of the Autumn 2004 Product Selection Guide. Over 300 products are summarized including 28 new products released in October '04. The selection guide is organized by product line as well as by market applications including: Cellular/3G, Broadband, Microwave and Fiber Optic. Request your copy of the new Autumn 2004 Selection Guide at [www.hittite.com](http://www.hittite.com) by selecting the "SUBMIT INQUIRY" left hand navigation button. New product data sheets can be found on-line.



**FOR MORE INFORMATION...**

**Hittite Microwave Corporation, USA**  
20 Alpha Road  
Chelmsford, MA 01824  
Phone: 978-250-3343  
Fax: 978-250-3373  
[hmc-sales@hittite.com](mailto:hmc-sales@hittite.com)

**Hittite Microwave Europe Limited**  
Intec 4.1 Wade Road  
Basingstoke, Hampshire RG24 8NE  
Phone: +44 1256-817000  
Fax: +44 1256-817111  
[europe@hittite.com](mailto:europe@hittite.com)

**Hittite Microwave Deutschland GmbH**  
Isarstrasse 1  
D83026 Rosenheim, Germany  
Phone: +49 8031-97654  
Fax: +49 8031-98883  
[germany@hittite.com](mailto:germany@hittite.com)

**Hittite Microwave Asia Co., Limited**  
POSCO Center Bldg. West Tower  
11th Floor 892 Daechi-dong,  
Kangnam-gu, Seoul, Korea 135-777  
Phone: (82-2) 559-0638  
Fax: (82-2) 559-0639  
[asia@hittite.com](mailto:asia@hittite.com)

**Hittite Microwave Co., Limited  
Shanghai Office**  
7T HongQiao Business Center  
No. 2272, HongQiao Road  
Shanghai, P.R.C.  
Phone: (86-21) 62376717  
Fax: (86-21) 62376716  
[china@hittite.com](mailto:china@hittite.com)

**Hittite Microwave Co., Limited  
Beijing Office**  
Phone: (86-10) 87756717  
Fax: (86-10) 87756899  
[china@hittite.com](mailto:china@hittite.com)

**NORTH AMERICA**

**CANADA**

Ottawa & Montreal  
Repwave-Sciencetech  
+613-270-9811  
Toronto  
Repwave-Sciencetech  
+905-465-1584

**USA North East;**

CT, MA, ME, NH, RI, VT  
dBm Technical Sales  
978-256-7100  
So. CT, Metro NY/LI & No. NJ  
TSR Marketing  
914-347-4948  
E. PA, So. NJ:  
Micro Lambda  
609-259-0400  
DC, DE, MD, VA, WV,  
Vincent Pirro Electronics  
410-489-9554

**USA Mid-West;**

IA, IN, KS, KY, MI, MN, MO,  
NE, OH, So. IL, WI, W. PA  
DyTec, Inc.  
800-872-5746  
No. IL  
TK Technologies Inc.  
847-991-7160

**USA South East;**

FL  
Spartech South  
321-727-8045

**USA South West;**

TX, OK, LA, AR  
N & W Sales, Inc.  
817-461-4443  
AZ, NM  
Saguaro Technical Sales, Inc.  
480-947-3724

**USA West;**

No. CA, NV  
Custom & Wireless Sales  
408-371-0222  
So. CA  
Acetec  
858-784-0900  
OR, WA, ID

CTC Sales Corporation  
425-392-8129  
CO, UT,  
W. Howard Associates, Inc.  
303-766-5755

**EUROPE, MID-EAST & AFRICA**

Benelux;  
Datron BV  
+31-35-6246649  
Czech Republic, Poland, Slovak Republic;  
Transtech Electronics Spol s.r.o.  
+420-2-6122-1039

**Denmark:**

Hittite Microwave Europe Limited  
+44 1256-817000

**Finland;**

Orbis OY  
+358-20-478-830

**France;**

Salies SA  
+33-1-69-02-2570

Germany, Austria, & Switzerland;  
Hittite Microwave Deutschland GmbH  
+49 8031-97654

Germany (Northern);  
MRC Components OHG  
+49 8161-9848-0

**Israel;**

Starlight Technologies, Inc.  
+972-3-9410555

**Italy;**

Special-Ind SPA  
+39-02-6074741

**Norway;**

Bredengen AS  
+47-2100-9100

**Spain, Portugal;**

Altaix Electronica S.A.L  
+34-91-636-39-39

**Sweden;**

Amtele AB  
+46-8-556-466-00

**South Africa;**

RF Design Laboratory CC  
+27-21-762-5365

**United Kingdom & Ireland;**

Link Microtek Ltd  
+44 1256-355-771

**ASIA & SOUTH PACIFIC**

Australia;  
ASD Technology Pty Ltd  
+61-2-9884-7486

China & Hong Kong;  
Secom Telecom Co., LTD.  
+86-755-25155888

Wai Tat Electronics Ltd.  
+852-2799-7393

**India;**

Syratron  
+91-80-5591107/5531031

Indonesia, Malaysia, Philippines,  
Singapore

MEDs Technologies, Pte., Ltd.  
+65-6453-8313

**Japan;**

Saint Technology  
+81-3-5330-6411  
Seki Technotron Corp.  
+81-33820-1711  
+81-6-6386-1232

**Korea;**

ENS Engineering  
+82-2-562-9819

**New Zealand;**

ASD Technology Pty Ltd  
+61-2-9884-7486

**Taiwan R.O.C.;**

Bandtek International Co., Ltd.  
+886-2-2657-2615

**AMERICAS DISTRIBUTION:**



Future Electronics  
800-Future-1  
Ext. 2754, Americas  
[www.FutureElectronics.com/rf](http://www.FutureElectronics.com/rf)

## What We Do

Hittite Microwave Corporation is an innovative designer and manufacturer of analog/digital ICs and MIC module assemblies for RF and microwave applications covering DC to 110 GHz. Hittite's RFIC/MMIC products are developed using state-of-the-art GaAs, InGaP/GaAs, InP, SOI and SiGe semiconductor processes utilizing MESFET, PHEMT, MHEMT and HBT devices. Our products include;

<i>Power Amplifiers</i>	<i>Attenuators</i>	<i>Mixers</i>	<i>VCOs</i>
<i>Gain Blocks</i>	<i>Phase Shifters</i>	<i>Converters</i>	<i>Dividers/Detectors</i>
<i>Driver Amplifiers</i>	<i>Switches</i>	<i>IRMs</i>	<i>Multipliers</i>
<i>LNAs</i>	<i>Transceivers</i>	<i>Modulators</i>	<i>PLOs / PLLs</i>

We also design and supply highly integrated custom ICs, MCMs and sub-assembly hybrids that combine multiple functions for specific requirements. We select the most appropriate semiconductor and package technologies, uniquely balancing digital and RF integration techniques, to produce a product that is easy and cost effective for our customers to use.

Our custom and standard products support a wide range of wireless and wired communications applications including those listed below:

<i>Broadband</i>	<i>802.11a/b/g, BLUETOOTH, UNII, WiMAX, CATV, DBS</i>
<i>Cellular</i>	<i>GSM, W-CDMA, PCS &amp; UMTS 3G, PLMR, &amp; Telematics</i>
<i>Microwave / Millimeterwave</i>	<i>P2P / P2MP / VSAT Radios, Test Equipment &amp; Sensors</i>
<i>Fiber Optic</i>	<i>OC-48 to OC-192</i>
<i>Military &amp; Space</i>	<i>RF to Millimeterwave Applications</i>

Every component is backed by Hittite Microwave's commitment to total quality. HMC is ISO 9001:2000 certified, and every Hittite employee and subcontractor is responsible for maintaining the highest level of quality. We are constantly working towards improvement of our procedures and processes, thus providing our customers with products that meet or exceed all requirements, are delivered on-time and function reliably throughout their useful life.

