



Features

- Shielded construction
- Inductance range: 1.0 to 100 μ H
- Heating current up to 5 A
- Dimensions: 6.7 x 6.7 x 4 mm
- AEC-Q200 qualified
- RoHS compliant* and halogen free**

Applications

- Automotive systems:
 - Driver assistant
 - Entertainment
 - Information
 - Lighting
- DC/DC converters
- Power supplies

SRR6040A Series - Shielded Power Inductors

Electrical Specifications @ 25 °C

Bourns Part Number	Inductance @ 10 kHz / 1 V		DCR (Ω) Typ.	DCR (Ω) Max.	I rms (A)	I sat (A)	***K-Factor
	L (μ H)	Tol. (%)					
SRR6040A-1R0Y	1.0	± 30	0.0098	0.015	5.0	5.55	388
SRR6040A-3R0Y	3.0	± 30	0.0153	0.021	3.5	3.33	233
SRR6040A-5R0Y	5.0	± 30	0.0184	0.025	2.9	2.63	184
SRR6040A-6R8Y	6.8	± 30	0.0223	0.03	2.5	2.17	152
SRR6040A-8R2Y	8.2	± 30	0.0266	0.036	2.3	2.0	140
SRR6040A-100M	10	± 20	0.0358	0.05	2.0	1.72	120
SRR6040A-120M	12	± 20	0.0397	0.055	1.7	1.61	113
SRR6040A-150M	15	± 20	0.0428	0.06	1.6	1.51	106
SRR6040A-180M	18	± 20	0.0551	0.075	1.5	1.35	94
SRR6040A-220M	22	± 20	0.0647	0.087	1.3	1.22	85
SRR6040A-270M	27	± 20	0.0769	0.105	1.2	1.11	78
SRR6040A-330M	33	± 20	0.0903	0.12	1.1	1.02	71
SRR6040A-390M	39	± 20	0.103	0.135	1.0	0.94	66
SRR6040A-470M	47	± 20	0.123	0.16	0.95	0.85	59
SRR6040A-560M	56	± 20	0.149	0.19	0.86	0.77	54
SRR6040A-680M	68	± 20	0.187	0.24	0.75	0.7	49
SRR6040A-820M	82	± 20	0.22	0.29	0.7	0.63	44
SRR6040A-101M	100	± 20	0.266	0.345	0.65	0.57	40

***K-Factor: To calculate core flux density, B_p -p (gauss) = $K \times L(\mu H) \times \Delta I$ (peak-to-peak ripple current, A), determine core loss from *Core Loss vs. Flux Density* plot.

Core Loss vs. Flux Density

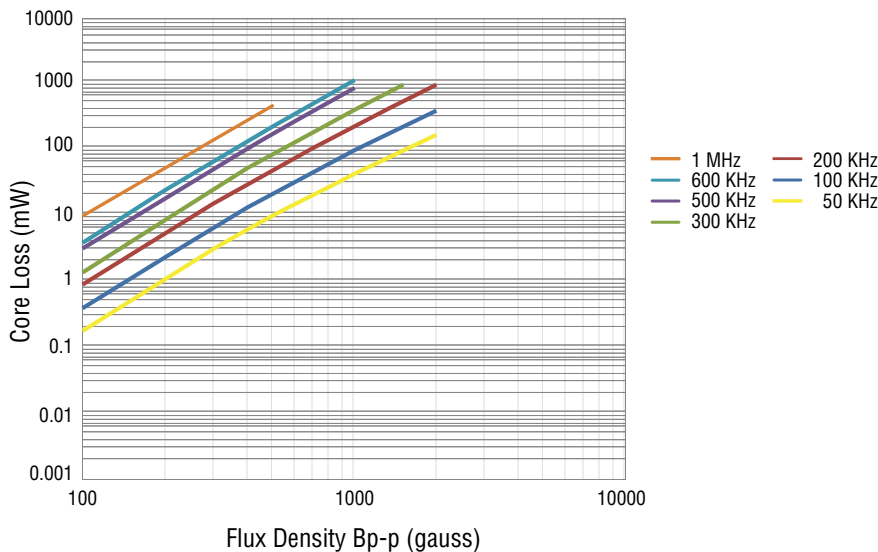

General Specifications

Operating Temperature -40 °C to +125 °C
 (Temperature rise included)
 Storage Temperature -40 °C to +125 °C
 Resistance to Solder Heat +250°C for 10 sec.
 Temperature Rise 30 °C typ. at rated I rms
 Inductance drop 35 % at I sat

Materials

Core Ferrite
 Wire Enameled copper
 Terminal Finish Sn
 Packaging 1000 pcs. per reel

Product Dimensions

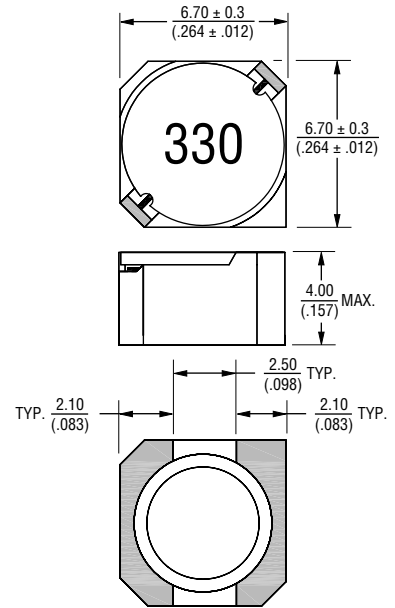

Recommended Layout

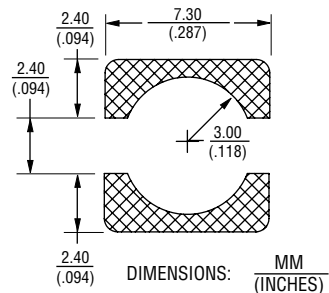

* RoHS Directive 2002/95/EC Jan. 27, 2003 including annex and RoHS Recast 2011/65/EU June 8, 2011.
 ** Bourns follows the prevailing definition of "halogen free" in the industry. Bourns considers a product to be "halogen free" if (a) the Bromine (Br) content is 900 ppm or less; (b) the Chlorine (Cl) content is 900 ppm or less; and (c) the total Bromine (Br) and Chlorine (Cl) content is 1500 ppm or less.
 Specifications are subject to change without notice.
 The device characteristics and parameters in this data sheet can and do vary in different applications and actual device performance may vary over time.
 Users should verify actual device performance in their specific applications.

SRR6040A Series - Shielded Power Inductors

BOURNS®

Electrical Schematic

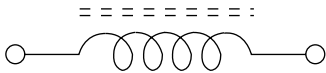

How to Order

SRR6040A - 100M

Model _____
Value Code (see table) _____

Inductance vs. IDC

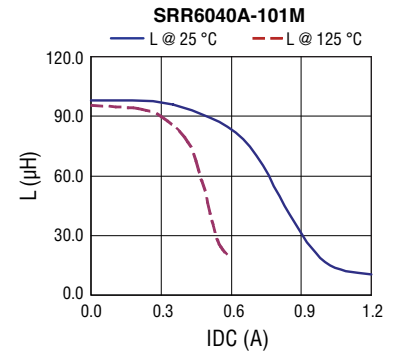
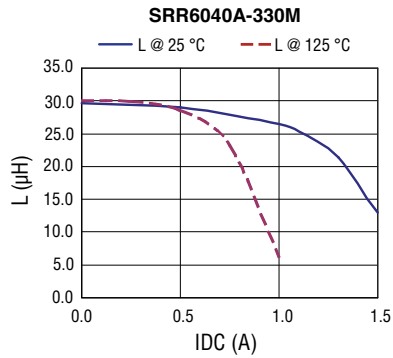
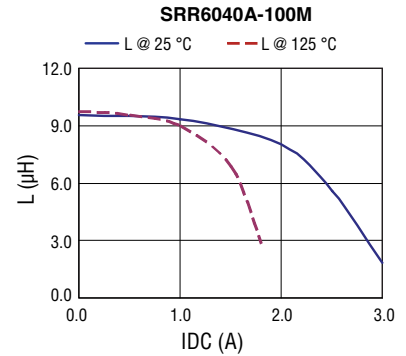
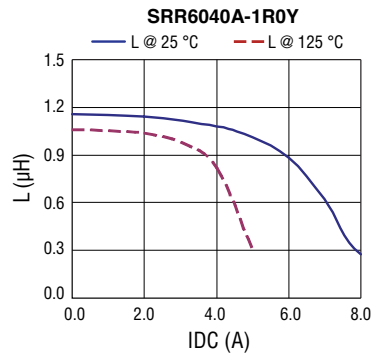

Temperature Rise vs. IDC

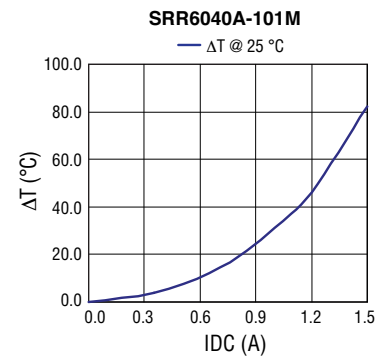
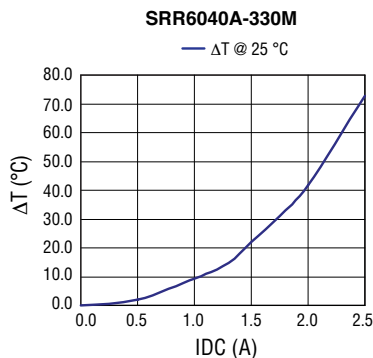
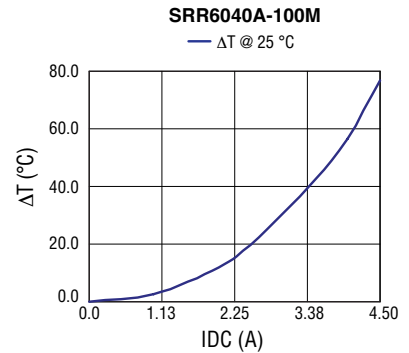
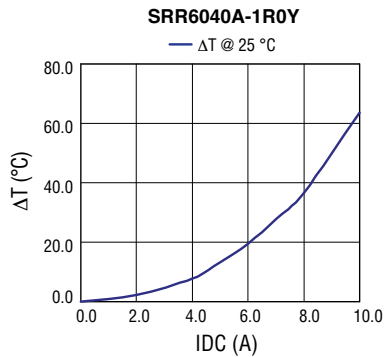

Specifications are subject to change without notice. The device characteristics and parameters in this data sheet can and do vary in different applications and actual device performance may vary over time. Users should verify actual device performance in their specific applications.

SRR6040A Series - Shielded Power Inductors

BOURNS®

Soldering Profile

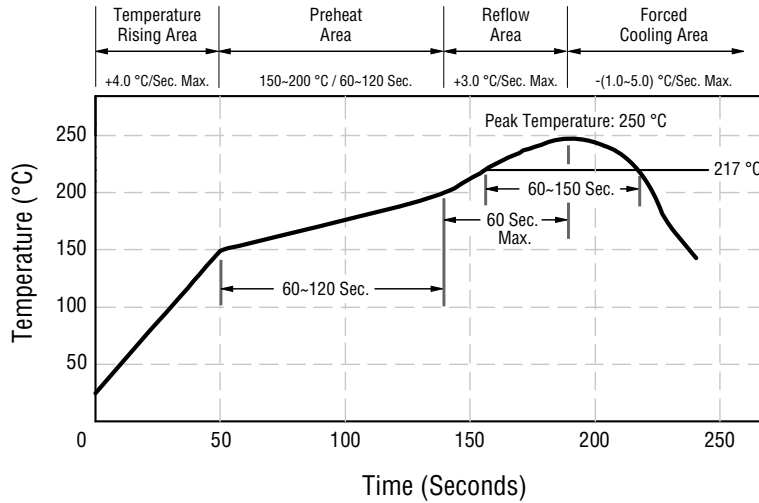

Peak Temperature: 250 °C max.
 Max. Peak Temperature -5 °C: 30 sec. max.
 Max. Time Above 217 °C: 60~150 sec. max.

Packaging Specifications

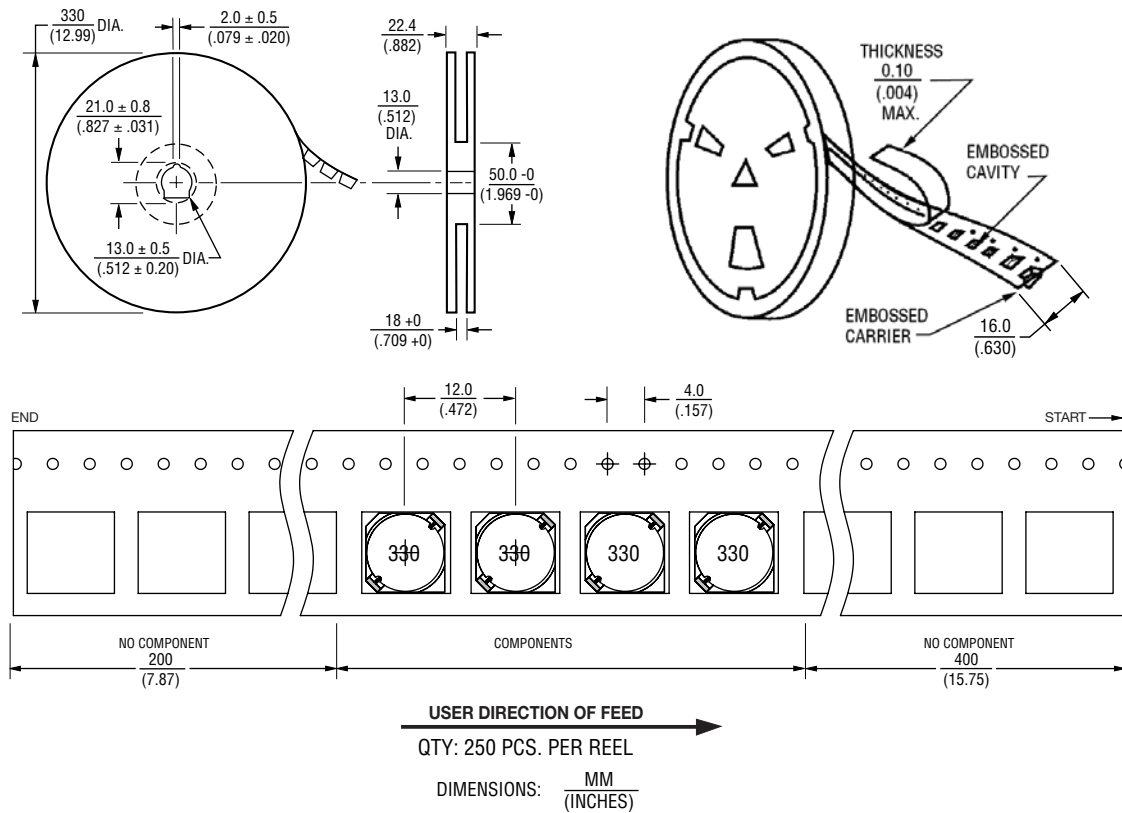

REV. 02/17

Specifications are subject to change without notice.
 The device characteristics and parameters in this data sheet can and do vary in different applications and actual device performance may vary over time.
 Users should verify actual device performance in their specific applications.