

MAX17536 3.3V Output Evaluation Kit

Evaluates: MAX17536 in 3.3V Output-Voltage Application

General Description

The MAX17536 3.3V output evaluation kit (EV kit) provides a proven design to evaluate this high-voltage, high-efficiency, synchronous step-down DC-DC converter. The EV kit is preset for a 3.3V output at load currents up to 4A and features a 450kHz switching frequency for optimum efficiency and component size. The EV kit features adjustable input, undervoltage lockout, adjustable soft-start, open-drain $\overline{\text{RESET}}$ signal, and external frequency synchronization.

Features

- Operates from a 4.5V to 60V Input Supply
- 3.3V Output Voltage
- Up to 4A Output Current
- 450kHz Switching Frequency
- Enable/UVLO Input, Resistor-Programmable UVLO Threshold
- Adjustable Soft-Start Time
- MODE Pin to Select Among PWM, PFM, or DCM Modes
- Open-Drain $\overline{\text{RESET}}$ Output
- External Frequency Synchronization
- Overcurrent and Overtemperature Protection
- Proven PCB Layout
- Fully Assembled and Tested

[Ordering Information](#) appears at end of data sheet.

Quick Start

Recommended Equipment

- MAX17536 3.3V output EV kit
- 4.5V to 60V, 10A DC input power supply
- Load capable of sinking 4A
- Digital voltmeter (DVM)

Procedure

The EV kit is fully assembled and tested. Follow the steps below to verify board operation. **Caution: Do not turn on power supply until all connections are completed.**

- 1) Set the power supply at a voltage between 4.5V and 60V. Disable the power supply.
- 2) Connect the positive terminal of the power supply to the VIN PCB pad and the negative terminal to the nearest PGND PCB pad. Connect the positive terminal of the 4A load to the VOUT PCB pad and the negative terminal to the nearest PGND PCB pad.
- 3) Connect the DVM across the VOUT PCB pad and the nearest PGND PCB pad.
- 4) Verify that shunts are installed across pins 1-2 on jumper JU1 and pins 2-3 on JU3 (see [Table 1](#) for details).
- 5) Select the shunt position on JU2 based on the intended mode of operation (see [Table 2](#) for details).
- 6) Turn on the DC power supply.
- 7) Enable the load.
- 8) Verify that the DVM displays 3.3V

MAX17536 3.3V Output Evaluation Kit

Evaluates: MAX17536 in 3.3V Output-Voltage Application

Detailed Description

The MAX17536 EV kit provides a proven design to evaluate the high-voltage, high-efficiency, synchronous step-down DC-DC converter. The EV kit is preset for a 3.3V output from a 4.5V to 60V input at load currents of up to 4A and features a 450kHz switching frequency for optimum efficiency and component size.

The EV kit includes an EN/UVLO PCB pad and JU1 to enable the output at the desired input voltage. The SYNC PCB pad and JU3 allow an external clock to synchronize the device. JU2 allows the selection of a particular mode of operation based on light-load performance requirements. An additional $\overline{\text{RESET}}$ PCB pad is available for monitoring whether the converter output is in regulation.

Soft-Start Input (SS)

The device utilizes an adjustable soft-start function to limit inrush current during startup. The soft-start time is adjusted by the value of the external capacitor from SS to GND (C3). The selected output capacitance (C_{SEL}) and output voltage (V_{OUT}) determine the minimum value of C3, as shown by the following equation:

$$C3 \geq 28 \times 10^{-6} \times C_{\text{SEL}} \times V_{\text{OUT}}$$

The soft-start time (t_{SS}) is related to C3 by the following equation:

$$t_{\text{SS}} = C3 / (5.55 \times 10^{-6})$$

For example, to program a 2.2ms soft-start time, C3 should be 12nF.

Regulator Enable/Undervoltage-Lockout Level (EN/UVLO)

The device offers an adjustable-input, undervoltage-lockout level. For normal operation, a shunt should be installed across pins 1-2 on JU1. To disable the output, install a shunt across pins 2-3 on JU1 and pull the EN/UVLO pin to GND. See [Table 1](#) for JU1 settings.

Set the voltage at which the device turns on with the resistive voltage-divider R1/R2 connected from V_{IN} to SGND. Connect the center node of the divider to EN/UVLO.

Choose R1 to be 3.32M Ω and then calculate R2 as follows:

$$R2 = \frac{R1 \times 1.215}{V_{\text{INU}} - 1.215}$$

where V_{INU} is the voltage at which the device is required to turn on.

Mode/SYNC Selection (MODE)

The device's MODE pin should be used to select among the PWM, PFM, or DCM modes of operation. The logic state of the MODE pin is latched when the V_{CC} and EN/UVLO voltages exceed the respective UVLO rising thresholds and all internal voltages are ready to allow LX switching. State changes on the MODE pin are ignored during normal operation. Refer to the MAX17536 IC data sheet for more information on the PWM, PFM, and DCM modes of operation.

[Table 2](#) shows EV kit jumper settings that can be used to configure the desired mode of operation.

The internal oscillator of the device can be synchronized to an external clock signal on the SYNC pin. The external synchronization clock frequency must be between $1.1f_{\text{SW}}$ and $1.4f_{\text{SW}}$, where f_{SW} is the frequency of operation set by R5. The minimum external clock high pulse width should be greater than 50ns and the minimum external clock low pulse width should be greater than 160ns.

Table 1. Regulator Enable (EN/UVLO) Description (JU1)

SHUNT POSITION	EN/UVLO PIN	MAX17536 OUTPUT
1-2*	Connected to VIN	Enabled
Not installed	Connected to the center node of resistor-divider R1 and R2	Enabled, UVLO level set through the R1 and R2 resistors
2-3	Connected to SGND	Disabled

*Default position.

Table 2. MODE Description (JU2)

SHUNT POSITION	MODE PIN	MAX17536 MODE
Not installed*	Unconnected	PFM mode of operation
1-2	Connected to SGND	PWM mode of operation
2-3	Connected to VCC	DCM mode of operation

*Default position.

MAX17536 3.3V Output Evaluation Kit

Evaluates: MAX17536 in 3.3V Output-Voltage Application

EV Kit Performance Report

(24V input voltage, unless otherwise noted.)

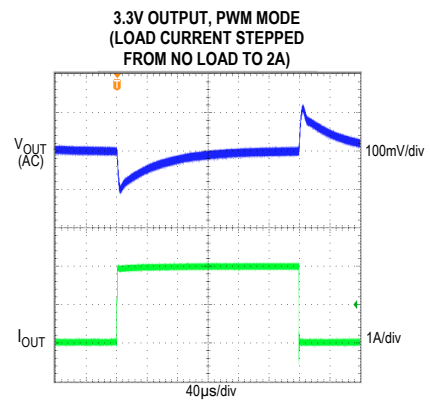
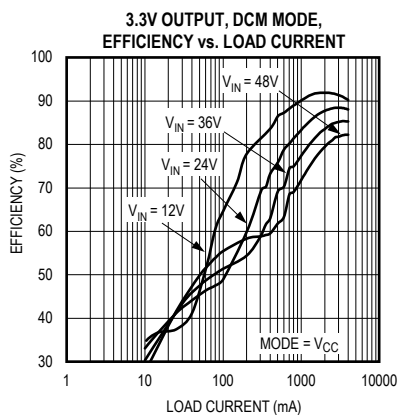
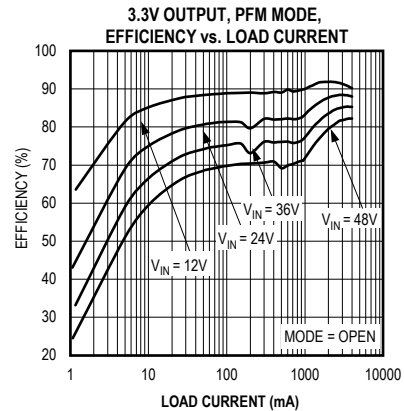
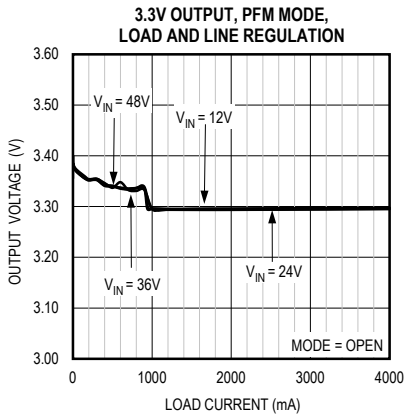
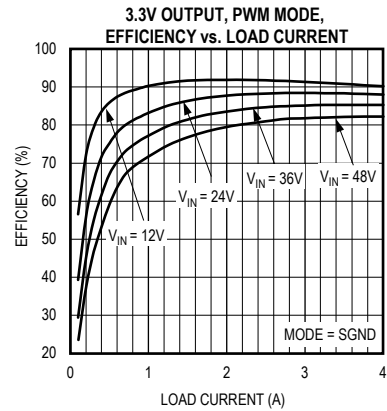
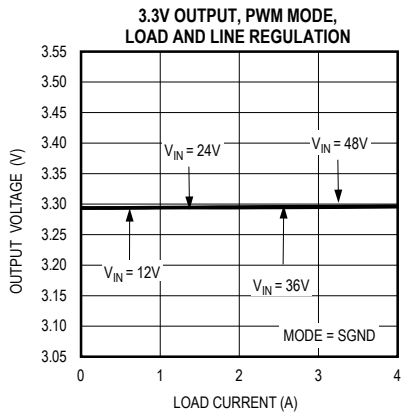

MAX17536 3.3V Output Evaluation Kit

Evaluates: MAX17536 in 3.3V Output-Voltage Application

EV Kit Performance Report (continued)

(24V input voltage, unless otherwise noted.)

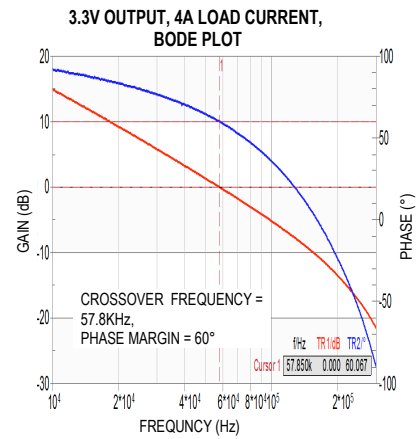
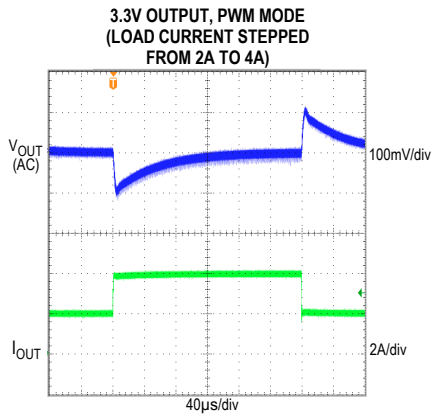
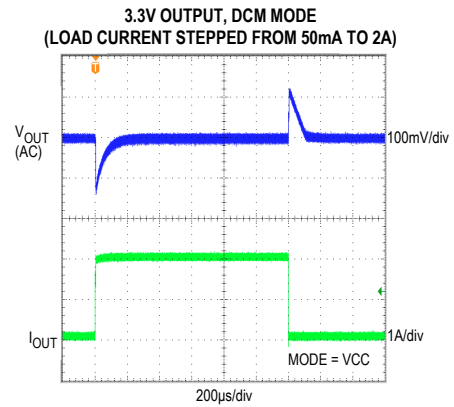
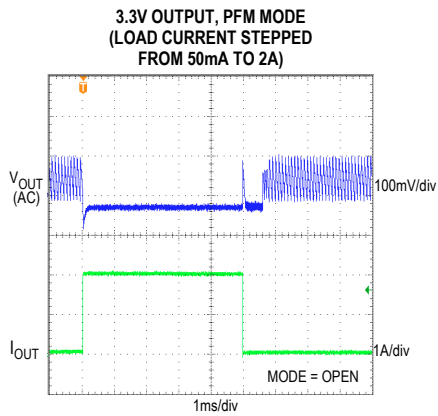

MAX17536 3.3V Output Evaluation Kit

Evaluates: MAX17536 in 3.3V
Output-Voltage Application

Component Suppliers

SUPPLIER	WEBSITE
Coilcraft, Inc.	www.coilcraft.com
Panasonic Corp.	www.panasonic.com
Renesas Electronics	www.renesas.com
Vishay	www.vishay.com

Note: Indicate that you are using the MAX17536 when contacting these component suppliers.

Component List, PCB Files and Schematic

See the following links for component information, PCB files, and schematics:

- [MAX17536 3.3V EV BOM](#)
- [MAX17536 3.3 EV PCB Files](#)
- [MAX17536 3.3 EV Schematics](#)

Ordering Information

PART	TYPE
MAX17536EVKITA#	EV Kit

#Denotes RoHS compliant.

Revision History

REVISION NUMBER	REVISION DATE	DESCRIPTION	PAGES CHANGED
0	6/15	Initial release	—

For pricing, delivery, and ordering information, please contact Maxim Direct at 1-888-629-4642, or visit Maxim Integrated's website at www.maximintegrated.com.

Maxim Integrated cannot assume responsibility for use of any circuitry other than circuitry entirely embodied in a Maxim Integrated product. No circuit patent licenses are implied. Maxim Integrated reserves the right to change the circuitry and specifications without notice at any time.



This document contains information considered proprietary, and shall not be reproduced wholly or in part, nor disclosed to others without specific written permission.

HARDWARE NAME: MAX17536A_EVKIT_A

HARDWARE NUMBER:

DATE: 04/10/2015

ODB++/GERBER: SILK_TOP

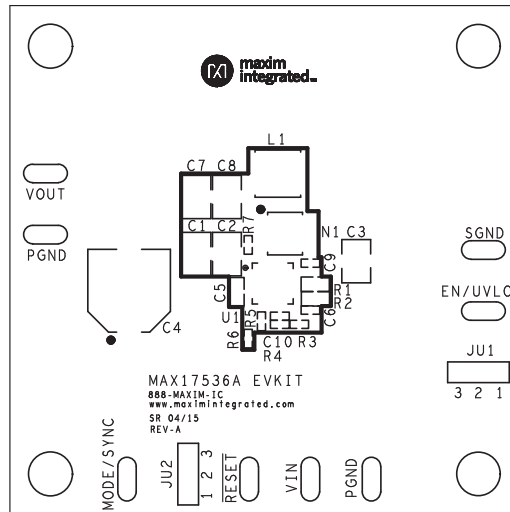



This document contains information considered proprietary, and shall not be reproduced wholly or in part, nor disclosed to others without specific written permission.

HARDWARE NAME: MAX17536A_EVKIT_A

HARDWARE NUMBER:

DATE: 04/10/2015

ODB++/GERBER: TOP

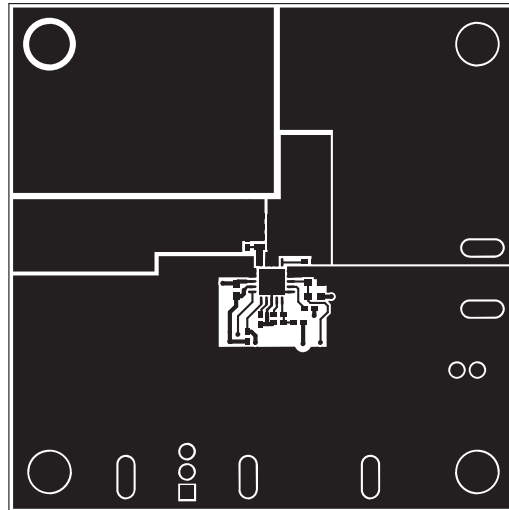



This document contains information considered proprietary, and shall not be reproduced wholly or in part, nor disclosed to others without specific written permission.

HARDWARE NAME: MAX17536A_EVKIT_A

HARDWARE NUMBER:

DATE: 04/10/2015

ODB++/GERBER: L2 - SGND

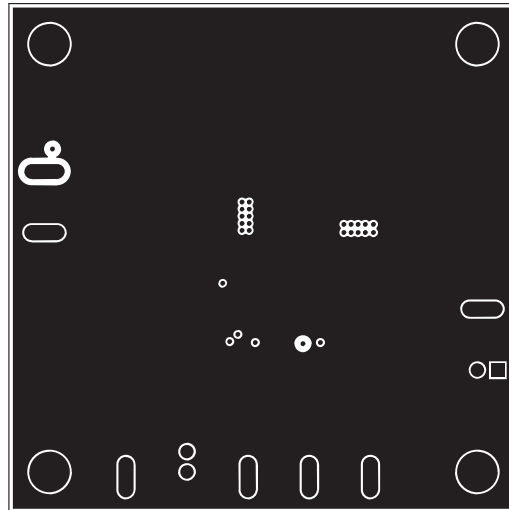



This document contains information considered proprietary, and shall not be reproduced wholly or in part, nor disclosed to others without specific written permission.

HARDWARE NAME: MAX17536A_EVKIT_A

HARDWARE NUMBER:

DATE: 04/10/2015

ODB++/GERBER: L3-SGND

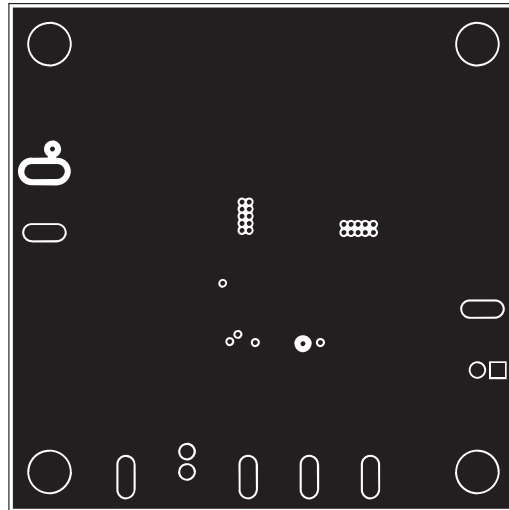



This document contains information considered proprietary, and shall not be reproduced wholly or in part, nor disclosed to others without specific written permission.

HARDWARE NAME: MAX17536A_EVKIT_A

HARDWARE NUMBER:

DATE: 04/10/2015

ODB++/GERBER: BOTTOM

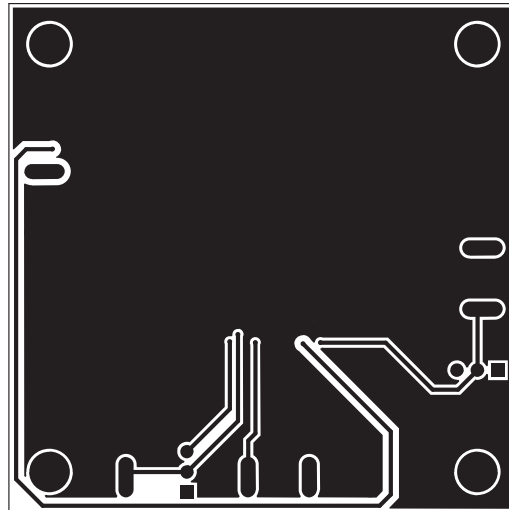



This document contains information considered proprietary, and shall not be reproduced wholly or in part, nor disclosed to others without specific written permission.

HARDWARE NAME: MAX17536A_EVKIT_A

HARDWARE NUMBER:

DATE: 04/10/2015

ODB++/GERBER: MASK_TOP

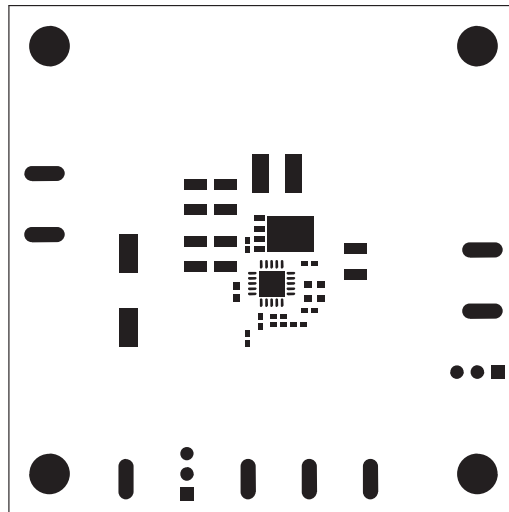



This document contains information considered proprietary, and shall not be reproduced wholly or in part, nor disclosed to others without specific written permission.

HARDWARE NAME: MAX17536A_EVKIT_A

HARDWARE NUMBER:

DATE: 04/10/2015

ODB++/GERBER: MASK_BOT

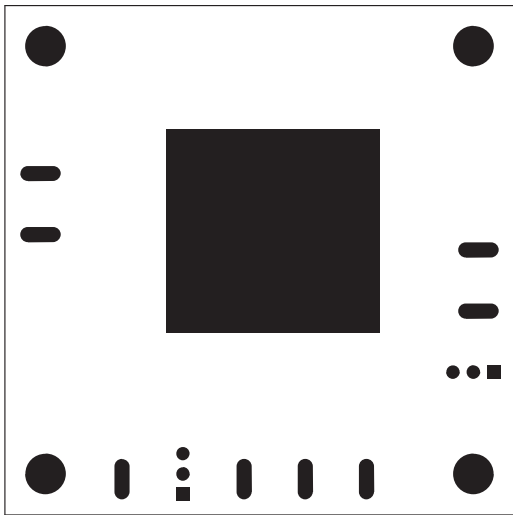

REVISIONS				
ZONE	LTR	DESCRIPTION	DATE	AUTHOR

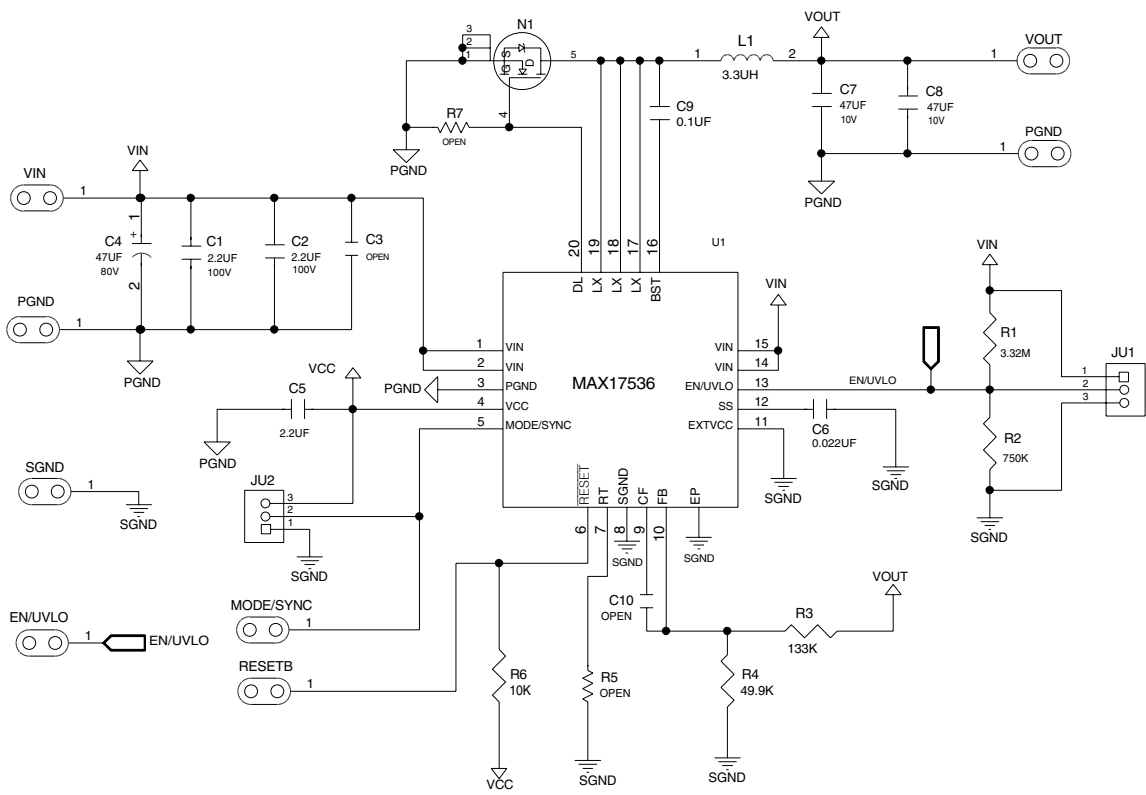

	PROJECT TITLE:	MAX17536A_EVKIT_A		
	DRAWING TITLE:			
THIS DOCUMENT CONTAINS INFORMATION PROPRIETARY TO MAXIM USE OR DISCLOSURE PERMISSION OF AN OFFICER OF MAXIM IS IS EXPRESSLY FORBIDDEN.	SIZE:	B	HARDWARE NUMBER:	
	ENGINEER:		DRAWN BY:	DATE: 08/04/15
			TEMPLATE REV:	REV: A
			B	

BILL OF MATERIALS (BOM) Revision 6/15

Serial No.	Description	Quantity	Designator	Part Number
1	2.2µF ±10%, 100V X7R ceramic capacitor (1210)	2	C1, C2	MURATA GRM32ER72A225KA35
2	Not installed, OPEN (1210)	0	C3	
3	47uF 80V aluminum electrolytic (D=10mm)	1	C4	PANASONIC EEEFK1K470P
4	2.2µF ±10%, 10V X7R ceramic capacitor (0603)	1	C5	MURATA GRM188R71A225K
5	22000pF ±10%, 50V X7R ceramic capacitor (0402)	1	C6	MURATA GRM155R71H223K
6	47uF ±10%, 10V X7R ceramic capacitor (1210)	2	C7, C8	MURATA GRM32ER71A476K
7	0.1µF ±10%, 50V X7R ceramic capacitor (0402)	1	C9	MURATA GRM155R71H104KE14
8	Not installed, OPEN (0402)	0	C10	
9	3-pin header (36-pin header 0.1" centers)	2	JU1, JU2	Sullins: PTC36SAAN
10	3.3uH Inductor (5.28mm x 5.48mm x 3.1mm)	1	L1	Coilcraft XAL5030-332
11	MOSFET (60V, 25A)	1	N1	Renesas RJK0651-DPB
12	3.32M ohm ±1%, resistor (0603)	1	R1	
13	750k ohm ±1%, resistor (0603)	1	R2	
14	133k ohm ±1%, resistor (0402)	1	R3	
15	49.9k ohm ±1%, resistor (0402)	1	R4	
16	Not installed, OPEN (0402)	0	R5	
17	10k ohm ±1%, resistor (0402)	1	R6	
18	Not installed, OPEN (0402)	0	R7	
19	Buck Converter MAX17536ATP+	1	U1	MAX17536ATP+
20	Shunt	2	See Jumper Table	SULLINS STC02SYAN

Jumper Table

JUMPER	SHUNT POSITION
JU1	1-2
JU2	1