

DESCRIPTION: MALE SOLDER CUP/STAMPED

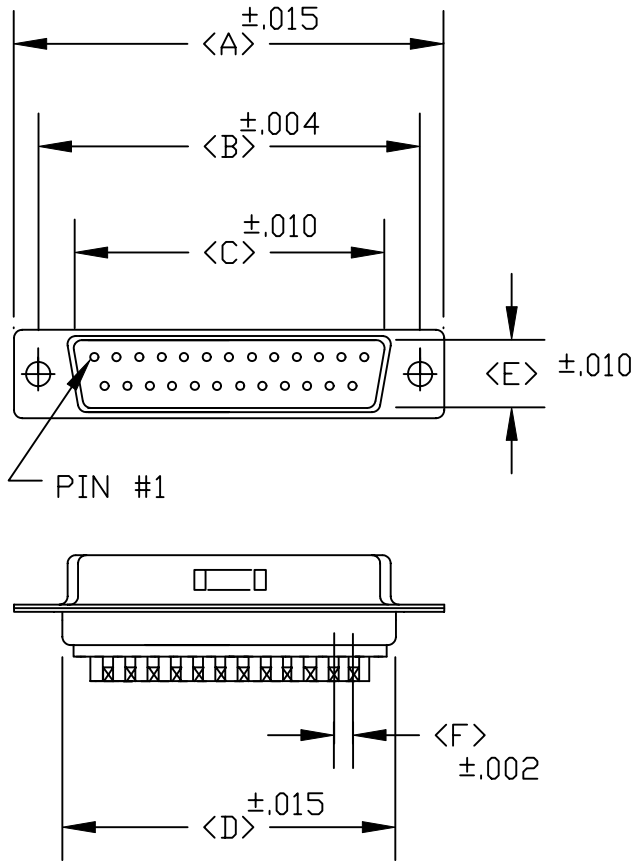

POS.	A	B	C	D	E	F	G
09	1.213	0.984	0.666	0.756	0.329	.109	0.496
	30.80	24.99	16.92	19.20	8.36	2.77	12.60
15	1.543	1.312	0.994	1.091	0.329	.109	0.496
	39.19	33.32	25.25	27.70	8.36	2.77	12.60
25	2.087	1.852	1.534	1.618	0.329	.109	0.496
	53.00	47.04	38.96	41.10	8.36	2.77	12.60
37	2.732	2.500	2.181	2.256	0.329	.109	0.496
	69.30	63.50	55.42	57.30	8.36	2.77	12.60
50	2.638	2.406	2.079	2.169	.436	.109	.602
	67.00	61.00	52.80	55.10	11.07	2.77	15.30

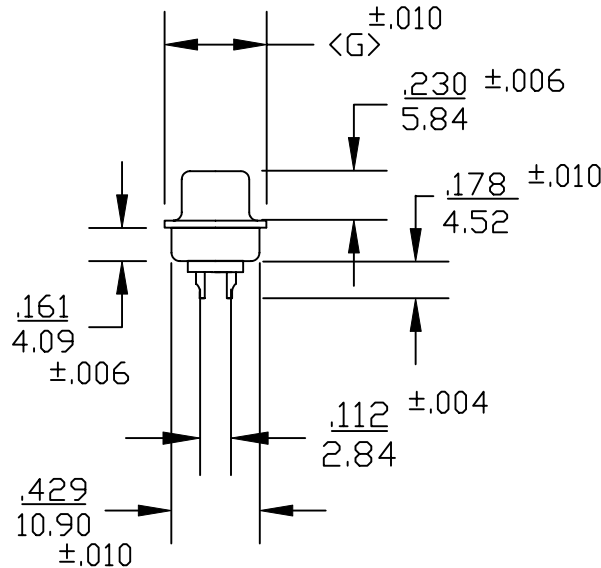

171-XXX-102-001

SERIES _____

POSITIONS _____

009

015

025

037

050

GENDER _____

1 = MALE

2 = FEMALE

TERMINATION _____

0 = SOLDER CUP

SHELL PLATING _____

2 = TIN

HARDWARE OPTIONS _____

00 = NO HARDWARE

01 = .098 4-40 CLINCH NUT BOARD SIDE

02 = .250 4-40 CLINCH NUT BOARD SIDE

03 = .250 4-40 CLINCH NUT MATING SIDE

91 = .225 4-40 SPACER/BOARD LOCK

PLATING OPTIONS _____

1 = GOLD FLASH

2 = 30 MICRO-INCH GOLD

SPECIFICATIONS:

MATERIALS:

SHELL: STEEL, TIN PLATED
 INSULATOR: UL 94V-0 RATED BLACK PBT
 +30% FIBER-GLASS OR NYLON-66

ELECTRICALS:

CURRENT RATING: 5 AMPS
 CONTACT RESISTANCE: 15 mOHMS MAX
 INSULATOR RESISTANCE: 1000 MOHMS MIN
 VOLTAGE: 500V AC FOR 1 MINUTE
 TEMPERATURE: -50°C TO +100°C

WILL ACCEPT 28-20 AWG CONDUCTORS

	THESE DRAWINGS AND SPECIFICATIONS ARE THE PROPERTY OF NorComp AND SHALL NOT BE REPRODUCED, COPIED OR USED AS THE BASIS FOR THE MANUFACTURE OR SALE OF APPARATUS WITHOUT WRITTEN PERMISSION.		DRAWN: PAM JENKINS	DATE: 8-24-98
			CHECKED:	DATE:
NorComp		SCALE:	SHEET OF	REV 4
		DWG. NO.		

DESCRIPTION: CLINCH NUT HARDWARE

ALL CLINCH-NUTS ARE 4-40 INTERNAL THREADS

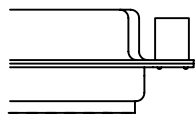

03X..... .250" (MATING SIDE) - CN8

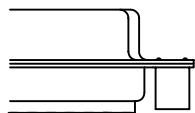

02X250" (BOARD SIDE) - CN2

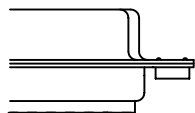

01X098" (BOARD SIDE) - CN1

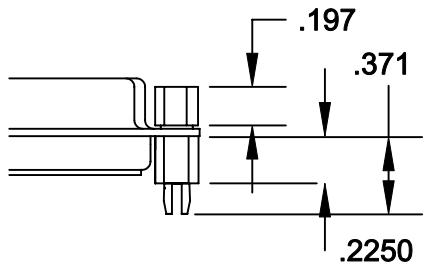

91X225" (BOARD SIDE) - .197 MATING SIDE - CN10/SFS0440

NOTE: 4-40 FEMALE SCREW LOCK IS REMOVABLE

	THESE DRAWINGS AND SPECIFICATIONS ARE THE PROPERTY OF NorComp AND SHALL NOT BE REPRODUCED, COPIED OR USED AS THE BASIS FOR THE MANUFACTURE OF SALE OF APPARATUS WITHOUT WRITTEN PERMISSION.		DRAWN: WAYNE ROBBINS	DATE: 8-23-98
	NorComp		CHECKED: PAM JENKINS	DATE: 8-24-98
SCALE:			SHEET 1 OF 1	REV 1
DWG NO.			CLINCH-NUT OPTIONS	