

## EZO™ class embedded pH circuit

### V 1.3

This is an evolving document  
check back for updates.

## Features

- Full range pH reading from .001 to 14.000
- Accurate pH readings down to the thousands place (**+/- 0.02**)
- Temperature dependent or temperature independent readings
- Flexible calibration protocol supports single point, 2 point, or 3 point calibration
- Calibration required only once per year with Atlas Scientific pH probe
- Single reading or continuous reading modes
- **Data format is ASCII**

### Two data protocols

- UART asynchronous serial connectivity
- (RX/TX voltage swing 0-VCC)
- I<sup>2</sup>C (default I<sup>2</sup>C address 0x63)
- Compatible with any microprocessor that supports UART, or I<sup>2</sup>C protocol
- Operating voltage: 3.3V to 5V
- Works with any off-the-shelf pH probe

### Sleep mode power consumption

- 0.995mA at 3.3V

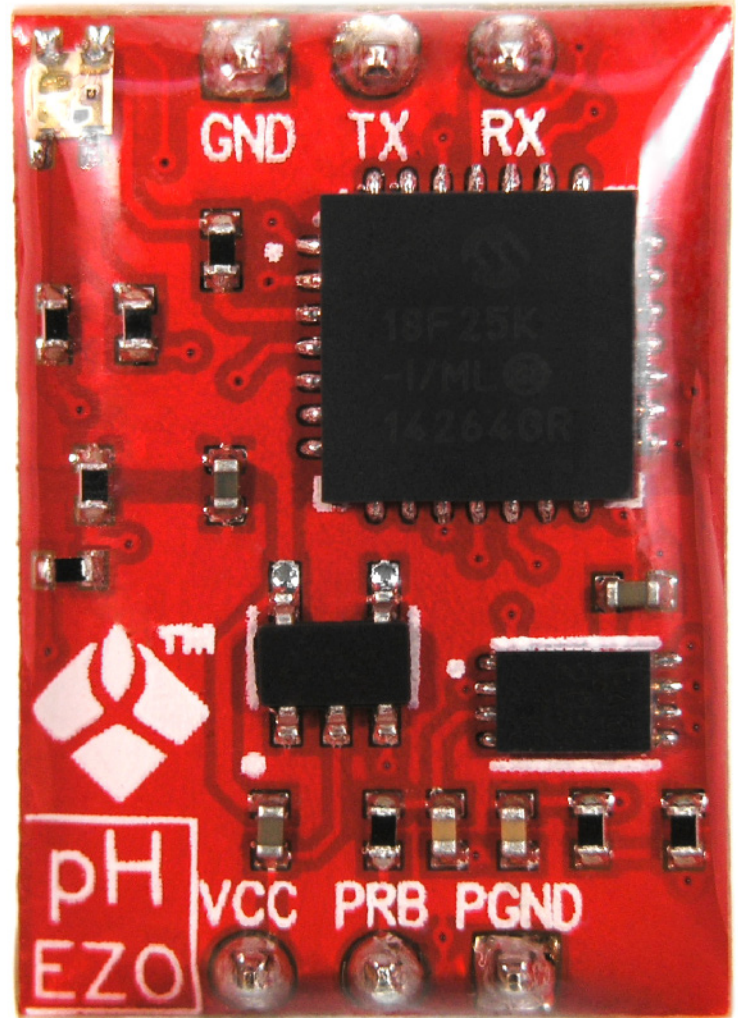

Patent pending

## Description

The Atlas Scientific™ EZO™ class embedded pH circuit, is our 6th generation embedded pH circuit. This EZO class pH circuit, offers the highest level of stability and accuracy. With proper configuration the EZO class pH circuit, can meet, or exceed the accuracy and precision found in most bench top laboratory grade pH meters. The pH-EZO™ pH circuit, can work with any off-the-shelf pH probe/sensor/electrode. **This device reads pH from a pH probe/sensor/electrode. This device does not include a pH probe/sensor/electrode.**



## Contents

System overview .....	3
Power consumption .....	4
Pin out .....	5
Device operation .....	6
Calibration theory .....	7
Design considerations .....	9
Power and data isolation .....	9
Board mounting .....	11
Calibration UART Mode .....	18
Calibration I <sup>2</sup> C Mode .....	36

## UART Mode

UART command quick reference ...	13
L,<1 0 ?> .....	14
C,<1 0 ?> .....	15
R .....	16
T,<XX.XX ?> .....	17
Cal,<type nnn> .....	18
Name,<nnn ?> .....	20
I .....	20
Response,<1 0 ?> .....	21
Status .....	22
Sleep .....	23
Serial,<nnn> .....	24
X .....	25
I2C,nnn .....	26
Manual switching to I <sup>2</sup> C mode .....	27

Circuit dimensions .....	45
Circuit footprint .....	46
Wiring diagram .....	47
Warranty information .....	48

## I<sup>2</sup>C Mode

I <sup>2</sup> C mode .....	29
Data from a read back event .....	30
I <sup>2</sup> C timing .....	31
I <sup>2</sup> C command quick reference .....	32
L,<1 0 ?> .....	33
R .....	34
T,<XX.XX ?> .....	35
Cal,<type nnn> .....	36
I .....	39
Status .....	40
Sleep .....	41
Serial,<nnn> .....	42
X .....	43
Manual switching to UART mode ..	44

## System overview

The EZO™ class pH circuit, is a small footprint computer system that is specifically designed to be used in robotics applications where the embedded systems engineer requires accurate and precise measurements of pH.

The EZO™ class pH circuit, is capable of reading pH, down to the thousands place.

### Example:

pH=4.768

In order to offer such resolution, considerable effort has been put into the design of the Atlas Scientific EZO™ class pH circuit. Components used, PCB topography and board metallurgy are all factors in achieving precise, high resolution readings. The Atlas Scientific EZO™ class pH circuit, converts a current generated by hydrogen ion activity into the pH. The current that is generated from the hydrogen ion activity is the reciprocal of that activity and can be predicted using this simple equation:

$$E = E^0 + \frac{RT}{F} \ln(\alpha_{H^+}) = E^0 - \frac{2.303RT}{F} pH$$

Where **R** is the ideal gas constant.

**T** is the temperature in Kelvin.

**F** is the Faraday constant.

It is important for the embedded systems engineer to keep in mind that it is not possible to simply read the current coming off of a pH probe and convert that voltage into a pH using an ADC.



Result will **always** read zero.

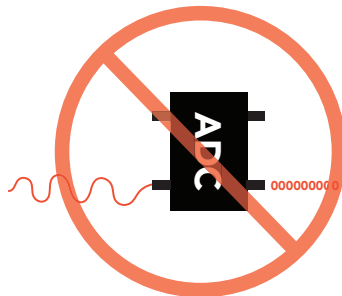

Result will **always** read zero.

## Power consumption

	LED	MAX	STANDBY	SLEEP
<b>5V</b>	ON	18.3 mA	16 mA	1.16 mA
	OFF	13.8 mA	13.8 mA	
<b>3.3V</b>	ON	14.5 mA	13.9 mA	0.995 mA
	OFF	13.3 mA	13.3 mA	

## Absolute maximum ratings\*

Parameter	MIN	TYP	MAX
Storage temperature (EZO <sup>TM</sup> pH circuit)	-40 C°		125 C°
Operational temperature (EZO <sup>TM</sup> pH circuit)	1 C°	25 C°	35 C°
VCC	3.3V	3.3V	5.5V

**\*Note:** Stresses above those listed under “Absolute Maximum Ratings” may cause permanent damage to the device. Exposure to maximum rating conditions for extended periods may affect device reliability

## Pin Out

<b>GND</b>	Return for the DC power supply
<b>Vcc</b>	Operates on 3.3V – 5.5V
<b>TX / SDA</b>	All EZO <sup>TM</sup> class circuits can operate in either UART mode, or I <sup>2</sup> C mode  The default state is UART mode. In UART mode, this pin acts as the transmit (TX) line. The default baud rate is 38400, 8 bits, no parity, no flow control, one stop bit. If standard RS232 voltage levels are desired, connect an RS232 converter such as a MAX232. If the device is in I <sup>2</sup> C mode, this pin acts as the Serial Data Line (SDA). The I <sup>2</sup> C protocol requires an external pull up resistor on the SDA line (resistor not included).
<b>RX / SCL</b>	All EZO <sup>TM</sup> class circuits can operate in either UART mode, or I <sup>2</sup> C mode.  The default state is UART mode. In UART mode, this pin acts as the receive (RX) line. If the device is in I <sup>2</sup> C mode, this pin acts as the Serial Clock Line (SCL). The I <sup>2</sup> C protocol requires an external pull up resistor on the SCL line (resistor not included).
<b>PRB</b>	This pin connects to the output lead of a pH probe/sensor/electrode
<b>PGND</b>	This pin connects to the ground lead of a pH probe/sensor/electrode

This pin is not ground.  
Do not tie this pin to system ground

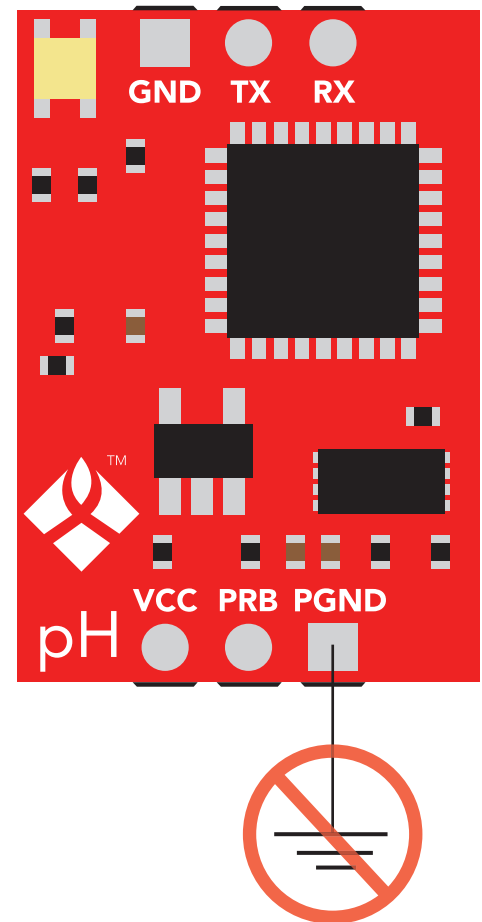

## Device operation

When an EZO™ class circuit is first powered up the boot sequence will begin. This is indicated by the LED moving from **Red** to **Green** to **Blue**. The boot up sequence takes 1 second. Once the device has booted up the circuit will output:

\*RE<CR>

Indicating the device is ready for operation.

The **Green** LED will also stay lit, indicating that the EZO™ class circuit is now operational in its default state.

## Default state

### Mode

UART

### Baud rate

38,400 bps  
8 data bits  
1 stop bit  
no parity  
no flow control

### Reading time

1 reading every second

### Probe type

Any off the shelf single, or double junction pH probe/sensor/electrode

### LEDs:

Enabled

Steady **Green** = Power on/ standby

**Red** double blink = Command received and not understood

**Green** double blink per data packet = Continuous data streaming

**Cyan** = taking a reading

### Data output: String

Encoding: ASCII characters followed by a carriage return <CR>  
Maximum string length: 10 characters

If the response code is enabled the EZO™ class circuit will respond "**\*OK<CR>**" after a command is acknowledged. If an unknown command is sent the pH Circuit will respond "**\*ER<CR>**" this will happen whether or not response codes are enabled

## Calibration theory

The Atlas Scientific EZO<sup>™</sup> class pH circuit, has a flexible calibration protocol, allowing for single point, two point, or three point calibration.

### The first calibration point must be a pH 7

This is known as the calibration midpoint. This is also the only calibration point used in a single point calibration.

The other two points can be any value, but they must be on opposite sides of the pH scale. These two points are known as the low calibration point and the high calibration point.

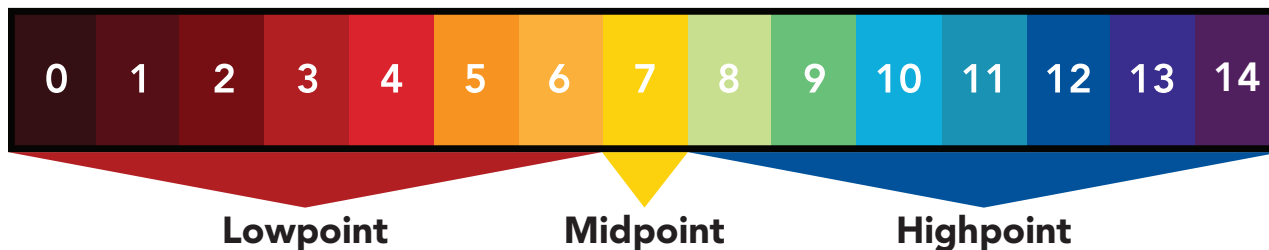

Using a commercially available pH 7 calibration solution that is not exactly pH 7.00 as pH 7.01 is not an issue.

Because the pH of calibration solutions change when they are not at standard temperature (25°C), any pH value can be entered in as the pH 7.00 value.

Generally speaking it is not advised to set the pH 7.00 calibration (the calibration midpoint) to a different value. This should only be used if the temperature of the water to be measured will continuously be very cold (< 10°C), or very hot (> 45°C).

No calibration



One point calibration

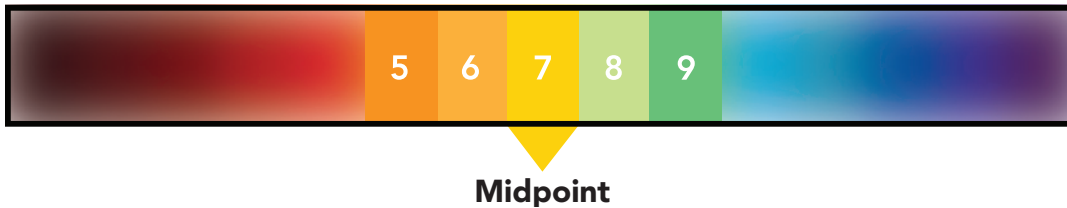

Two point calibration will provide high accuracy between pH 7 and the second point calibrated against, such as a pH 4.

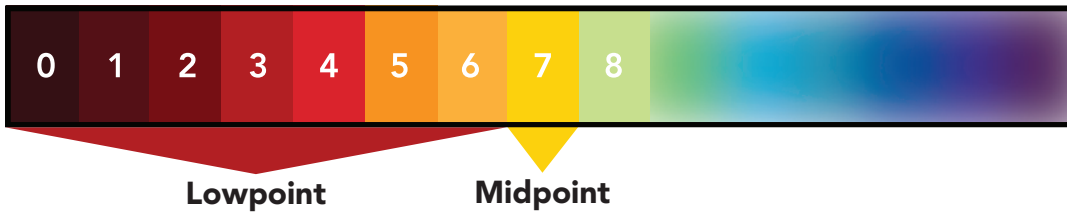

Three point calibration will provide high accuracy over the full pH range. 3 point calibration at pH 4, 7 and 10 should be considered the standard.

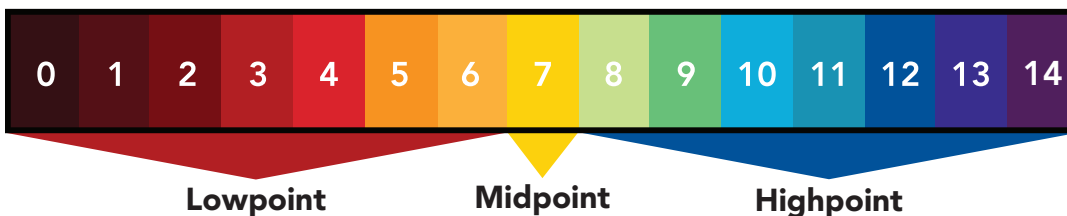

Only the calibration at pH 7 is mandatory. The other calibration points can be any value. The further apart these values are, the greater the accuracy.



## Design considerations

The Atlas Scientific EZO™ pH circuit is a micro-computer system that is specifically designed to be embedded into a larger system. The EZO™ pH circuit is not a completed product. The embedded systems engineer is responsible for building a completed working product.

## Power and data isolation

The Atlas Scientific EZO™ pH circuit is a very sensitive device. This sensitivity is what gives the pH circuit its accuracy. This also means that the pH circuit is capable of reading micro-voltages that are bleeding into the water from unnatural sources such as pumps, solenoid valves or other sensors.

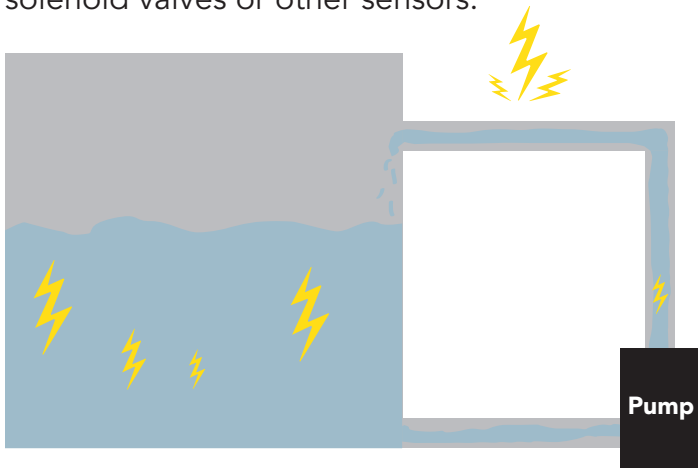

When electrical noise is interfering with the pH readings it is common to see rapidly fluctuating readings or readings that are consistently off. To verify that electrical noise is causing inaccurate readings place the pH probe in a cup of water by itself. The readings should stabilize quickly, confirming that electrical noise was the issue.

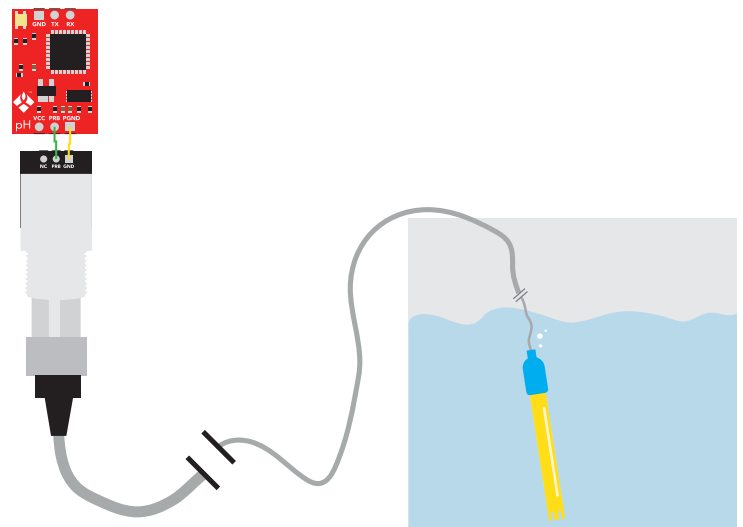

To correct this problem the power and data lines need to be electrically isolated. There is no one single method of doing this. This is just one of many ways to do so.

The SI8600 is a digital isolator with two bidirectional channels, which makes it excellent for use with I2C and UART protocols. This Part requires isolated power and pull ups on both channels on the isolated and non-isolated inputs. Pull up resistors can be anything from 3k to 10k.

The ROE-0505s is an isolated DC/DC converter that can handle 5V @ 1W. This part uses a Transformer that provides a 1:1 ratio (5V in and 5v out) however we have seen that 5V in produces 5.4V out and we recommend using a 5V regulator on its output.

**Note:** The Isolated Ground is different from the non-isolated Ground, these two lines should not be connected together.

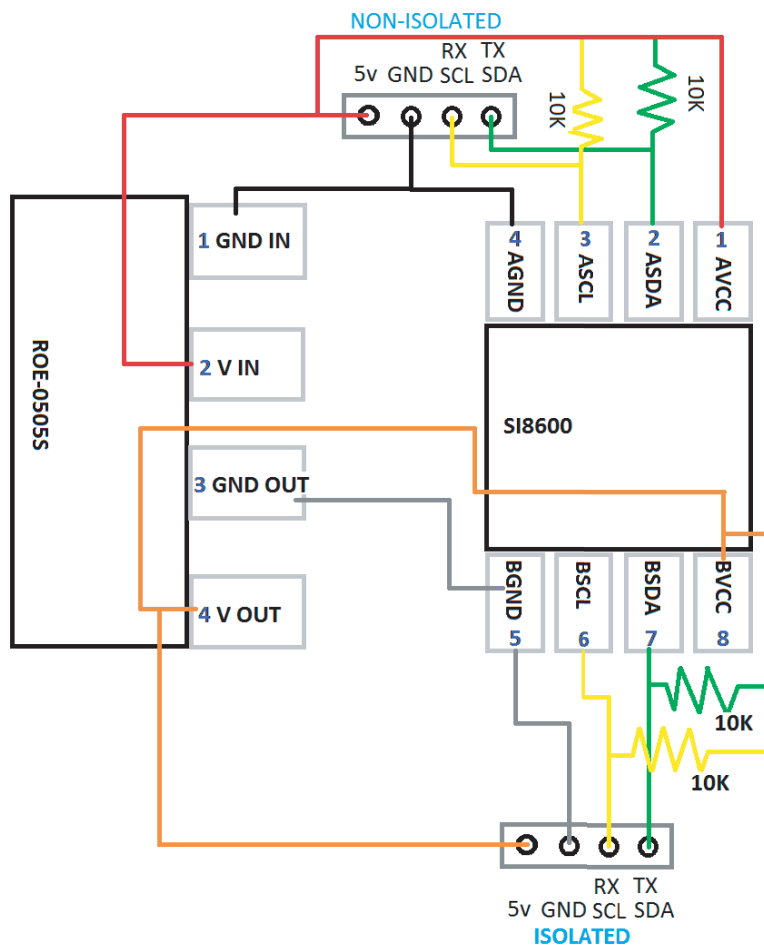

## Board mounting

The Atlas Scientific EZO<sup>™</sup> pH circuit should be tested in a bread board with different colored jumper wires connecting to each pin of the EZO<sup>™</sup> pH circuit.

The EZO<sup>™</sup> pH circuit should not have wires for other devices in your system laying on top of it. If long term use is desired a PCB should be made to hold the device.

**Protoboards or Perfboards should never be used.**

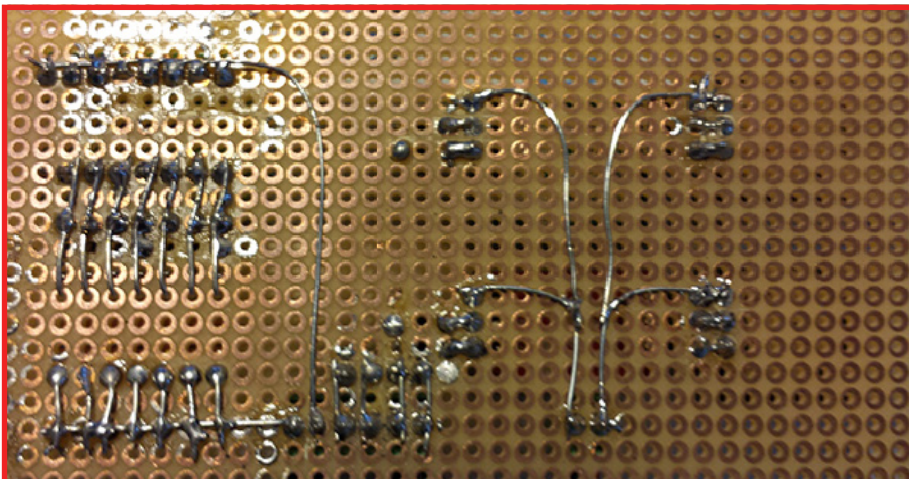
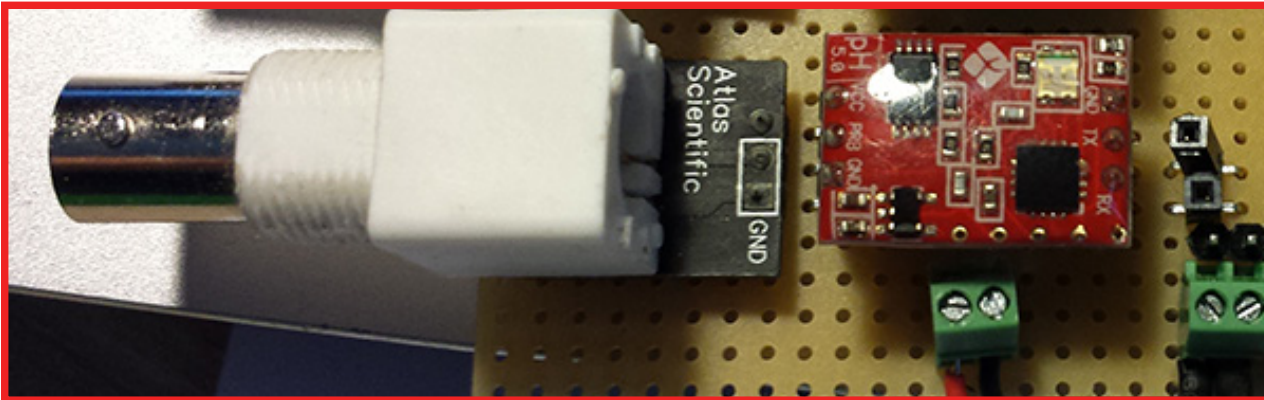

Micro-shorts and bleeding voltages are very common when using such boards. Achieving stable reading can be quite difficult or impossible.

**Using Protoboards or Perfboards will void your devices warranty.  
No support will be given.**

# UART Mode



# UART mode command quick reference

There are a total of 13 different commands that can be given to the EZO<sup>TM</sup> class pH circuit.

**All commands are ASCII strings or single ASCII characters**

Command	Function	Default state
C,<1 0 ?>	Enable / Disable or Query continuous readings (pg.15)	Enabled
Cal,<type,nnn>	Performs calibration (pg.18)	User must calibrate
I	Device information (pg.20)	N/A
I2C,<nnn>	Sets the I <sup>2</sup> C ID number (pg.26)	Not set
L,<1 0 ?>	Enable / Disable or Query the LEDs (pg.14)	LEDs Enabled
Name,<nnn ?>	Set or Query the name of the device (pg.20)	Not set
R	Returns a single reading (pg.16)	N/A
Response,<1 0 ?>	Enable / Disable or Query response code (pg.21)	Enabled
Serial,<nnn>	Set the baud rate (pg.24)	38400
Sleep	Enter low power sleep mode (pg.23)	N/A
Status	Retrieve status information (pg.22)	N/A
T,<XX.XX ?>	Set or Query the temperature compensation (pg.17)	25°C
X	Factory reset (pg.25)	N/A

# UART command definitions

<CR> represents a carriage return (ASCII 13). The user does not transmit the literal string "<CR>".  
Commands are not case sensitive.

## LED control

All EZO™ class circuits have a tri color LED, used to indicate device operation.

UART mode LED color definitions:

Steady **Green**= Power on/ standby

**Red** double blink = Command received and not understood

**Green** blink=Data transmission sent

**Cyan**= taking a reading

### Command syntax

L,1<CR> LED enable

L,0<CR> LED disable

L,? <CR> Query the LED

### Device response

L,1 <CR>

(If the response code is enabled, the EZO™ class circuit will respond "\*OK<CR>")

The Led will be enabled and the green power on/ standby LED will turn on

L,0 <CR>

(If the response code is enabled, the EZO™ class circuit will respond "\*OK<CR>")

The Led will be disabled

L,? <CR>

(If the response code is enabled, the EZO™ class circuit will respond "\*OK<CR>")

?L,1<CR> if the LED is enabled

?L,0<CR> if the LED is disabled

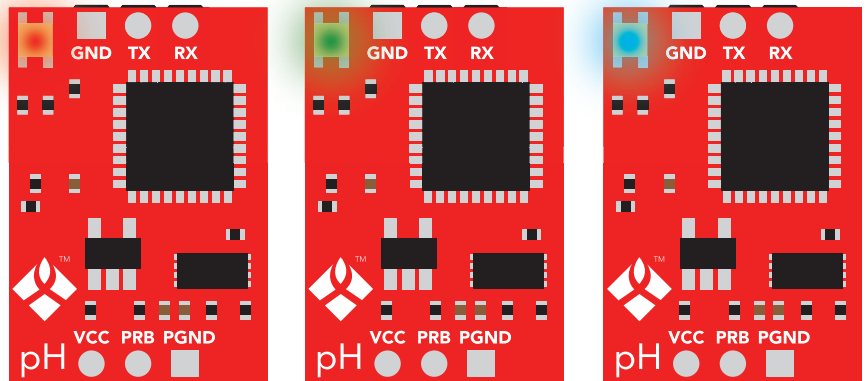

**<CR> represents a carriage return (ASCII 13). The user does not transmit the literal string "<CR>".  
Commands are not case sensitive.**

## Continuous reading mode

All EZO<sup>™</sup> class circuits are capable of continuous mode operation. In continuous mode, the device will output its readings, one after the other continuously until the continuous mode disable command has been issued. All EZO<sup>™</sup> class circuits are defaulted to operate in continuous mode. If the LEDs are enabled, each time a data transmission occurs, the green LED will blink.

### Command syntax

C,1<CR>      Continuous mode enable  
C,0<CR>      Continuous mode disable  
C,?<CR>      Query continuous mode

### Device response

C,1 <CR>

(If the response code is enabled, the EZO<sup>™</sup> class circuit will respond "\*OK<CR>")

The EZO<sup>™</sup> class pH circuit, will output a numeric string containing the pH once per second

pH<CR> (1 second)

pH<CR> (2 seconds)

pH<CR> (n\* seconds)

C,0 <CR>

(If the response code is enabled, the EZO<sup>™</sup> class circuit will respond "\*OK<CR>")

Continuous data transmission will cease.

C,? <CR>

(If the response code is enabled, the EZO<sup>™</sup> class circuit will respond "\*OK<CR>")

?C,1<CR> if continuous mode is enabled.

?C,0<CR> if continuous mode is disabled.

<CR> represents a carriage return (ASCII 13). The user does not transmit the literal string "<CR>".  
Commands are not case sensitive.

## Single reading mode

All EZO<sup>TM</sup> class circuits are capable of taking a single reading upon request. If the LEDs are enabled, each time a data transmission occurs, the green LED will blink.

### Command syntax

R<CR> Returns a single reading

### Device response

(If the response code is enabled, the EZO<sup>TM</sup> class circuit will respond "\*OK<CR>")

The EZO<sup>TM</sup> class pH circuit, will output a single string containing a pH reading **1 second** after the command was issued.

pH<CR> (**1 second**)



**<CR> represents a carriage return (ASCII 13). The user does not transmit the literal string "<CR>".  
Commands are not case sensitive.**

## Temperature compensation

In order to achieve the most accurate possible readings, the temperature of the liquid being measured must be transmitted to the EZO<sup>TM</sup> class pH circuit. The embedded systems engineer must keep in mind that the EZO<sup>TM</sup> class pH circuit, cannot read the temperature from a pH probe or from a temperature probe. Another device must be used to read the temperature. EZO<sup>TM</sup> class pH circuit, has its default temperature set at 25°C. The temperature at which to compensate against can be changed at any time using the "T" command.

Temperature is always in Celsius

### Command syntax

(Using an example temperature 19.5)

T,19.5<CR>     Where the temperature is any value; floating point or int, in ASCII form  
T,?<CR>        Query the set temperature

### Device response

T,19.5<CR>

(If the response code is enabled, the EZO<sup>TM</sup> class circuit will respond "\*OK<CR>")

There is no other output associated output with this command

T,?<CR>

(If the response code is enabled, the EZO<sup>TM</sup> class circuit will respond "\*OK<CR>")

?T,19.5 <CR>

**<CR> represents a carriage return (ASCII 13). The user does not transmit the literal string "<CR>".  
Commands are not case sensitive.**

## Calibration

The Atlas Scientific EZO<sup>™</sup> class pH circuit, has a flexible calibration protocol, allowing for single point, two point, or three point calibration.

During calibration, it is required that pH 7 calibration be done first. Calibration can be done at a maximum of 3 points. These three points are known as the low calibration point, the middle calibration point and the high calibration point. Where pH 7.XX must be the first calibration point. This is known as the middle calibration point.

### Command syntax

Cal,mid,X.XX<CR> Where X.XX is any floating point value that represents the pH midpoint.  
In most cases this should be 7.00

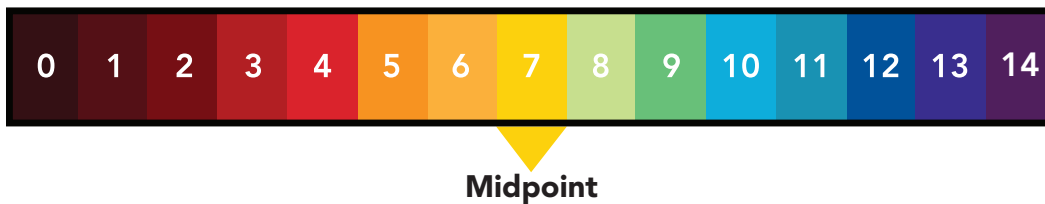

Cal,low,X.XX<CR> Where X.XX is any floating point value that represents a low calibration point (pH 1 to pH 6)



Cal,high,XX.XX<CR> Where XX.XX is any floating point value that represents a high calibration point (pH 8 to pH 14)



## Device response

Cal,clear<CR>

(If the response code is enabled, the EZO<sup>™</sup> class circuit will respond "\*OK<CR>")  
There is no other output associated output with this command.

Cal,mid,X.XX<CR>

(If the response code is enabled, the EZO<sup>™</sup> class circuit will respond "\*OK<CR>")  
The LED will turn **Cyan** during the calibration.

Cal,low,X.XX<CR>

(If the response code is enabled, the EZO<sup>™</sup> class circuit will respond "\*OK<CR>")  
The LED will turn **Cyan** during the calibration.

Cal,high,XX.XX<CR>

(If the response code is enabled, the EZO<sup>™</sup> class circuit will respond "\*OK<CR>")  
The LED will turn **Cyan** during the calibration.

Cal,?<CR>

(If the response code is enabled, the EZO<sup>™</sup> class circuit will respond "\*OK<CR>")

If not calibrated:	?CAL,0
If single point calibration:	?CAL,1
If two point calibration:	?CAL,2
If three point calibration:	?CAL,3

Issuing the cal,mid command after the EZO<sup>™</sup> class pH circuit has been calibrated will clear other calibration points. Full calibration will have to be redone.

Issuing a cal,low or cal,high command can be done at any time and will have no effect on other previously set calibration points.

**<CR> represents a carriage return (ASCII 13). The user does not transmit the literal string "<CR>".  
Commands are not case sensitive.**

## Device Identification

All EZO<sup>™</sup> class circuits are capable of being assigned a name. This is a simple way to identify the device in a system that consists of multiple EZO<sup>™</sup> class circuits. A name can consist of any combination of ASCII characters, with a length of 1 to 16 characters long, **no blank spaces**.

### Command syntax

NAME,nnn<CR>      Sets the device name, where nnn is the given name.  
NAME,?<CR>        Query the device name

### Device response

NAME,DEVICE\_1<CR>  
(If the response code is enabled, the EZO<sup>™</sup> class circuit will respond "\*OK<CR>")  
There is no other output associated output with this command.

NAME,?<CR>  
(If the response code is enabled, the EZO<sup>™</sup> class circuit will respond "\*OK<CR>")  
?NAME, DEVICE\_1<CR>

## Device information

The EZO<sup>™</sup> class circuit can identify itself by device type and firmware version. This is done by transmitting the "I" command.

### Command syntax

I<CR>      Device information

### Device response

?I,pH,1.0<CR>  
(If the response code is enabled, the EZO<sup>™</sup> class circuit will respond "\*OK<CR>")

**<CR> represents a carriage return (ASCII 13). The user does not transmit the literal string "<CR>".  
Commands are not case sensitive.**

## Response codes

The Atlas Scientific EZO<sup>TM</sup> class circuits, have 7 response codes to help the user understand how the device is operating, and to aid in the construction of a state machine to control the EZO<sup>TM</sup> class circuit. All EZO<sup>TM</sup> class devices indicate a response code has been triggered, by transmitting a string with the prefix "\*" and ending with a carriage return <CR>.

### A list of response codes

<b>*ER</b>	An unknown command has been sent
<b>*OV</b>	The circuit is being overvoltage (VCC>=5.5V)
<b>*UV</b>	The circuit is being undervoltage (VCC<=3.1V)
<b>*RS</b>	The circuit has reset
<b>*RE</b>	The circuit has completed boot up
<b>*SL</b>	The circuit has been put to sleep
<b>*WA</b>	The circuit has woken up from sleep

Only the response code "\*OK" can be disabled.  
Disabling this response code is done using the "response" command.

#### Command syntax

RESPONSE,1<CR>	Enable response code (default)
RESPONSE,0<CR>	Disable response code
RESPONSE,?<CR>	Query the response code

#### Device response

RESPONSE,1<CR>  
EZO<sup>TM</sup> class circuit will respond "\*OK<CR>"

RESPONSE,0<CR>  
There is no response to this command

RESPONSE,?<CR>

?RESPONSE,1<CR> If the response code is enabled  
?RESPONSE,0<CR> If the response code is disabled

**<CR> represents a carriage return (ASCII 13). The user does not transmit the literal string "<CR>".  
Commands are not case sensitive.**

## Reading the status of the device

The Atlas Scientific<sup>™</sup> EZO<sup>™</sup> class circuit, is able to report its voltage at the VCC pin and reason the device was last restarted.

### Restart codes

<b>P</b>	power on reset
<b>S</b>	software reset
<b>B</b>	brown out reset
<b>W</b>	watchdog reset
<b>U</b>	unknown

### Command syntax

STATUS<CR>

### Device response

(If the response code is enabled, the EZO<sup>™</sup> class circuit will respond "\*OK<CR>")

?STATUS,P,5.038<CR>

Where: P is the reason for the last reset event

Where: 5.038 is the its voltage at the VCC

**<CR> represents a carriage return (ASCII 13). The user does not transmit the literal string "<CR>".  
Commands are not case sensitive.**

## Low power state

To conserve energy in between readings, the Atlas Scientific<sup>™</sup> EZO<sup>™</sup> class circuit, can be put into a low power sleep state. This will turn off the LEDs and shut down almost all of the internal workings of the EZO<sup>™</sup> class circuit. The power consumption will be reduced to 1.16 mA at 5V and 0.995 mA at 3.3V. **To wake the EZO<sup>™</sup> class circuit, send it any character.**

### Command syntax

SLEEP<CR>      Enter low power sleep state

### Device response

(If the response code is enabled, the EZO<sup>™</sup> class circuit will respond "\*\*OK<CR>")  
\*SL<CR>

Device response to wake up:

\*WA<CR>

**<CR> represents a carriage return (ASCII 13). The user does not transmit the literal string "<CR>".  
Commands are not case sensitive.**

## Change baud rate

The Atlas Scientific EZO<sup>TM</sup> class circuit, has 8 possible baud rates it can operate at.  
The default baud rate is

**38400 bps**  
**8 data bits**  
**1 stop bit**  
**no parity**  
**no flow control**

Data bits, stop bits, parity and flow control are fixed and cannot be changed.

1. 300 bps
2. 1200 bps
3. 2400 bps
4. 9600 bps
5. 19200 bps
6. 38400 bps
7. 57600 bps
8. 115200 bps

### Command syntax

(Using an example baud rate of 9600)  
SERIAL,9600<CR>

### Device response

(If the response code is enabled, the EZO<sup>TM</sup> class circuit will respond "\*OK<CR>") The EZO<sup>TM</sup> class circuit will respond with a **Purple** LED double blink. The EZO<sup>TM</sup> class circuit will then restart at the new baud rate.

The LED blink will happen even if the LEDs are disabled.

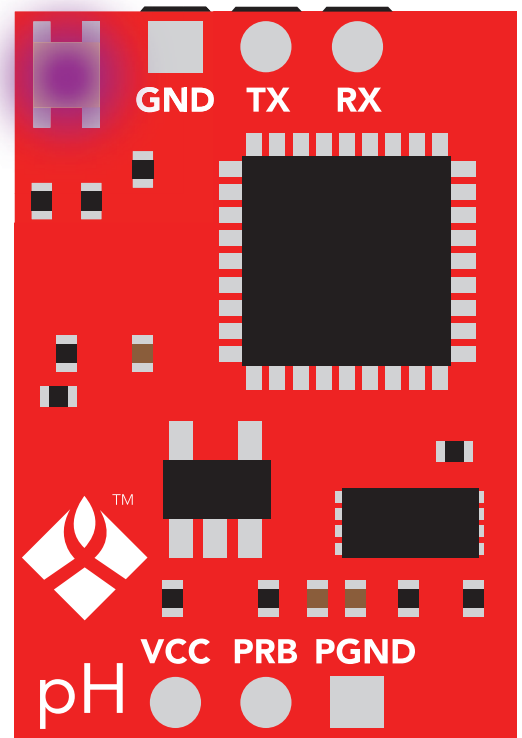



**<CR> represents a carriage return (ASCII 13). The user does not transmit the literal string "<CR>".  
Commands are not case sensitive.**

## Factory reset

All EZO™ class circuits, are capable of resetting themselves to the original factory settings. Issuing a factory reset will:

- Reset the calibration back to factory default
- Reset default temperature to 25°C
- Set debugging LED to on.
- Enable response codes

**This command will not change the set baud rate.**

### Command syntax

X<CR> Factory reset

### Device response

(If the response code is enabled, the EZO™ class circuit will respond "\*OK<CR>")

The EZO™ class circuit, will respond: \*RE<CR>

<CR> represents a carriage return (ASCII 13). The user does not transmit the literal string "<CR>".  
Commands are not case sensitive.

## Switch from UART mode to I<sup>2</sup>C mode

Transmitting the command I<sup>2</sup>C,[n] will set the EZO<sup>TM</sup> class circuit into I<sup>2</sup>C mode from UART mode. **Where [n] represents any number from 1-127.** The I<sup>2</sup>C address is sent in decimal ASCII form. Do not send the address in hexadecimal ASCII form.

### Command syntax

(Using as example an I<sup>2</sup>C ID number of 99)  
I2C[99]<CR>

### Device response

If an address > 127 is given

\*ER      Indicating an error has occurred

If an address >0 and <128 is given

(If the response code is enabled, the EZO<sup>TM</sup> class circuit will respond "\*OK<CR>")

\*RS<CR>      The device will restart in I<sup>2</sup>C mode

The **Green** LED used to indicate that the device is powered and awaiting an instruction will now change to **Blue**.

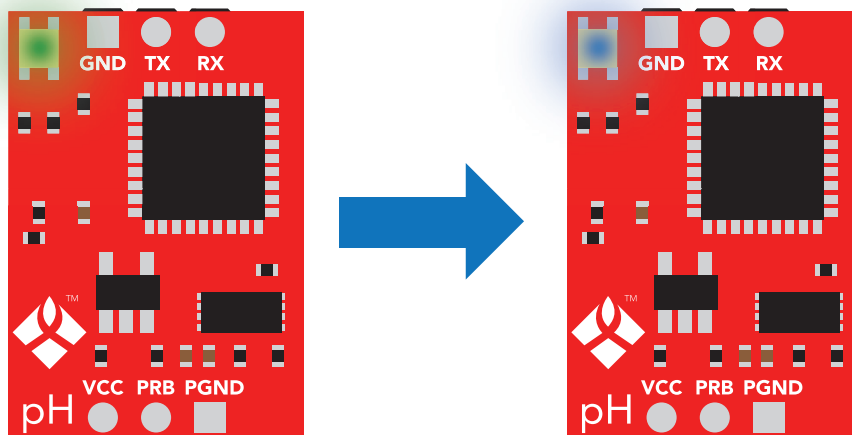

<CR> represents a carriage return (ASCII 13). The user does not transmit the literal string "<CR>".  
Commands are not case sensitive.

## Manual switching to I<sup>2</sup>C mode

All EZO<sup>TM</sup> class circuits can be manually switched from UART mode, to I<sup>2</sup>C mode. **If this is done the EZO<sup>TM</sup> class pH circuit, will set its I<sup>2</sup>C address to 99 (0x63).**

1. Cut the power to the device
2. Short the right probe pin to the TX pin
3. Power the device
4. Wait for LED to change from **Green** to **Blue**
5. Remove the short from the probe pin to the TX pin.
6. Power cycle the device
7. The device is now I<sup>2</sup>C mode.

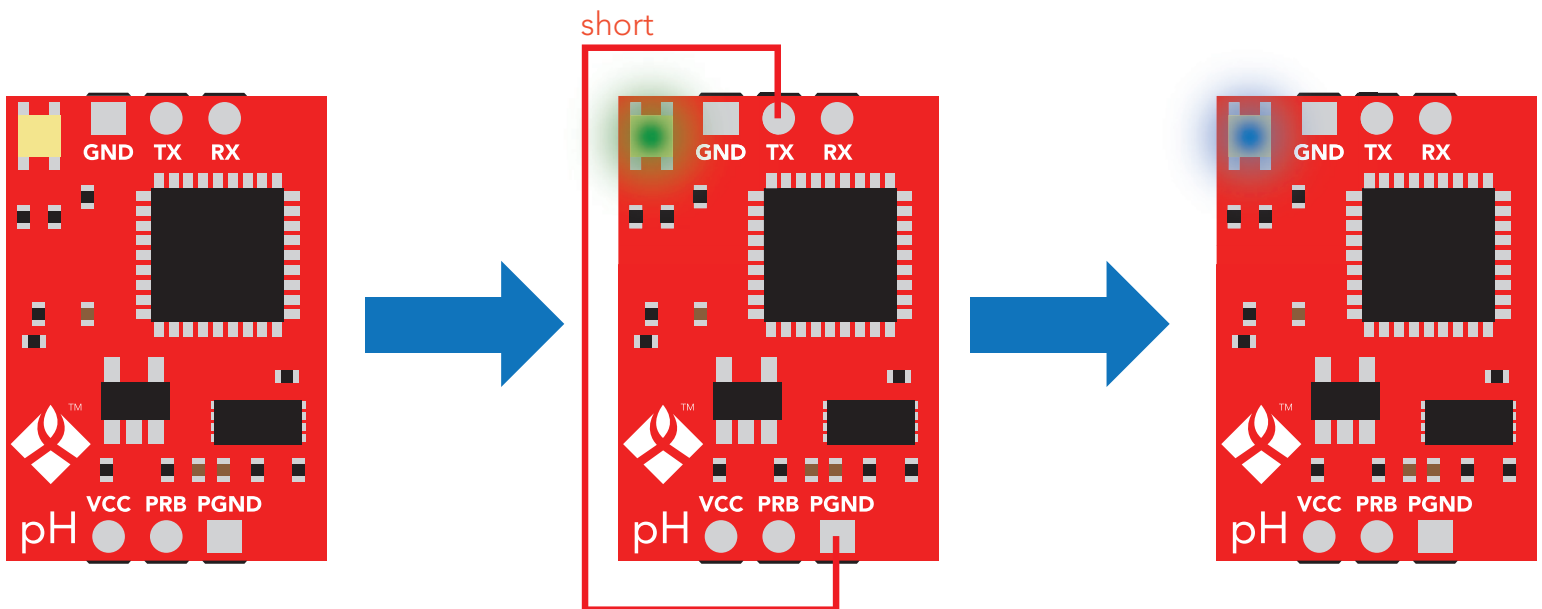

# I<sup>2</sup>C Mode



## I<sup>2</sup>C mode

An I<sup>2</sup>C address can be any number from 1-127. If the EZO™ Class pH circuit was put into I<sup>2</sup>C mode by jumping PRB to TX, the I<sup>2</sup>C address is 99(0x63).

Once an EZO™ class device has been put into I<sup>2</sup>C mode the green power LED that was used in UART mode will now switch to a **Blue** LED. This indicates the device is now in I<sup>2</sup>C mode.

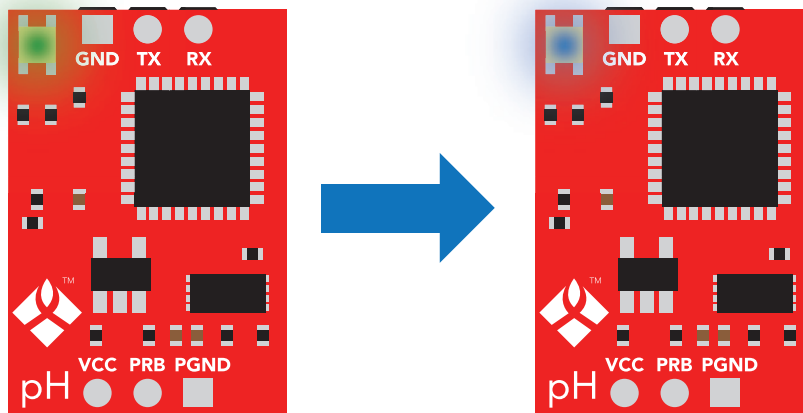

The I<sup>2</sup>C protocol is considerably more complex than the UART (RS-232) protocol. Atlas Scientific assumes the embedded systems engineer understands this protocol.

Communication to the EZO™ class device is controlled by the master. The EZO™ class device as an I<sup>2</sup>C slave. The slave device is not able to initiate any data transmissions.

### An I<sup>2</sup>C write event is defined as such



In order to get the response from device, it is necessary to initiate a read command. The I<sup>2</sup>C protocol does not permit the slave device to initiate any data transmissions.

### An I<sup>2</sup>C read event is defined as such



## Data from a read back event

The first byte of the data read back, is the response code. This byte informs the master of the status of the data about to be read back. For all commands, the first byte of the read data is the response code, which is defined as

Value	Meaning
255	<b>No Data</b> – there is no pending request, so there is no data to return from the circuit
254	<b>Pending</b> – the request is still being processed. Ensure that you have waited the minimum time to guarantee a response
2	<b>Failed</b> – the request failed
1	<b>Success</b> – the requested information is ready for transmission. There may be more bytes following this which are returned data

The bytes transmitted after that, will be the requested data. When all the data has been transmitted each additional byte will be a NULL.

### Example

A read request when no command has been given.



All I<sup>2</sup>C mode responses are in ASCII format however, they do not terminate with a <CR> rather, they terminate with a NULL. The Null termination makes data manipulation easier once it has been received.

## Example

EZO™ class device responds to a request for a reading

12.3 ≠ float	12.3 =byte[5]	
	<b>Byte[0]= 1</b>	(decimal 1)
	<b>byte[1]= "1"</b>	(ASCII 49)
	<b>byte[2]= "2"</b>	(ASCII 50)
	<b>byte[3]= "."</b>	(ASCII 46)
	<b>byte[4]= "3"</b>	(ASCII 51)
	<b>byte[5]= NULL</b>	(ASCII 0)

## I<sup>2</sup>C timing

When a command is issued to the EZO™ class device, a certain amount of time must be allowed to pass before the data is ready to be read. Each command specifies the delay needed before the data can be read back. EZO™ class devices do not support I<sup>2</sup>C clock stretching. All commands are sent to the EZO™ class device in the same ASCII format as in UART mode however, there is no <CR> sent at the end of the transmission.

## I<sup>2</sup>C command quick reference

There are a total of 9 different commands that can be given to the EZO<sup>TM</sup> class pH circuit.

Command	Function
Cal,<type,nnn>	Performs calibration (pg.36)
I	Device information (pg.39)
L,<1 0 ?>	Enable / Disable or Query the LEDs (pg.33)
R	Returns a single reading (pg.34)
Serial,<nnn>	Switch back to UART mode (pg.42)
Sleep	Enter low power sleep mode (pg.41)
Status	Retrieve status information (pg.40)
T,<XX.XX ?>	Set or Query the temperature compensation (pg.35)
X	Factory reset (pg.43)



## I<sup>2</sup>C LED control

All EZO™ class circuits have a tri color LED used to indicate device operation.

I<sup>2</sup>C mode LED color definitions:

Steady **Blue**= Power on/ standby

**Red** double blink = Command received and not understood

**Blue** blink=Data transmission sent

**Cyan**= taking a reading

### Command syntax

L,1 LED enable

L,0 LED disable

L,? Query the LED

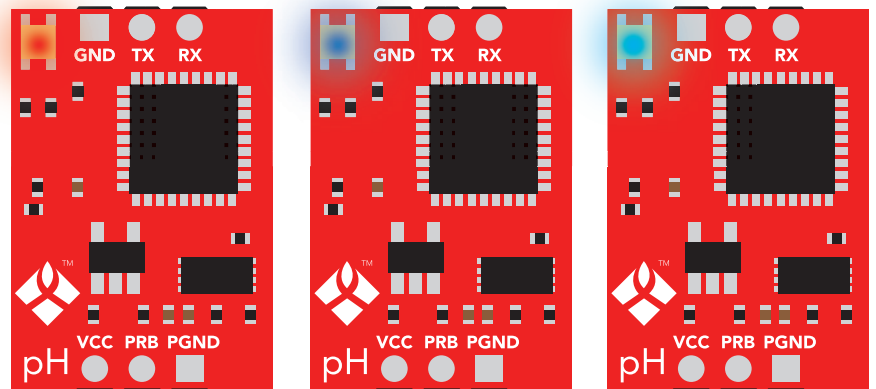

### Device response

L,1

The Led will be enabled and the blue power on/ standby LED turn on.

After 300ms, an I<sup>2</sup>C read command can be issued to get the response code. A decimal 1 would indicate the command has been successfully processed.



L,0

The Led will be disabled

After 300ms, an I<sup>2</sup>C read command can be issued to get the response code. A decimal 1 would indicate the command has been successfully processed.



L,?

After 300ms, an I<sup>2</sup>C read command can be issued to get the response code.



## I<sup>2</sup>C take reading

When a reading is taken, the LED (if enabled) will turn **Cyan**, indicating that a reading is being taken. Once the reading has been taken, the LED will turn back to **Blue**.

### Command syntax

R Returns a single reading

Time until instruction is processed: 1 second

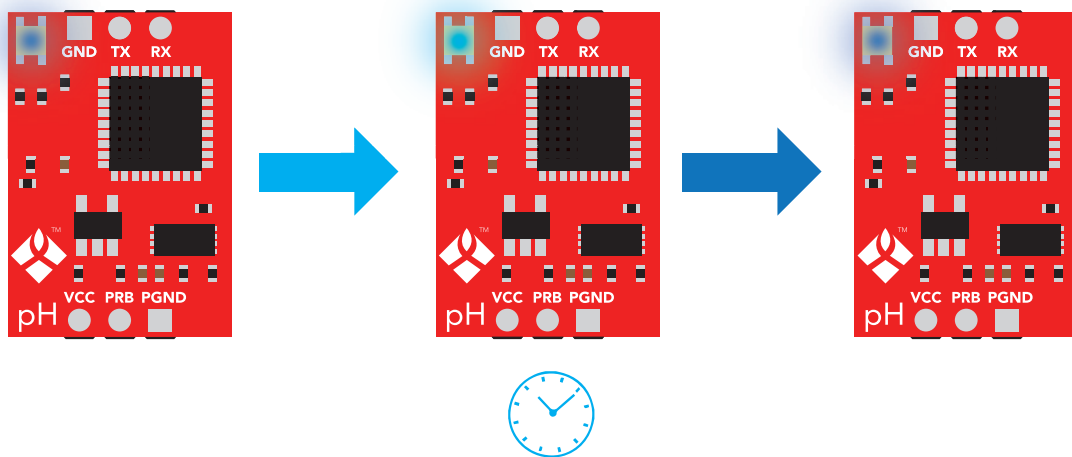

### Device response

After 1 second, an I<sup>2</sup>C read command can be issued to get the response:

1 pH null

pH represents many bytes.

The string will be no longer than 7 bytes.

## I<sup>2</sup>C Temperature compensation

In order to achieve the most accurate possible readings, the temperature of the liquid being measured must be transmitted to the EZO<sup>™</sup> class pH circuit. The embedded systems engineer must keep in mind that the EZO<sup>™</sup> class pH circuit, cannot read the temperature from a pH probe, or from a temperature probe. Another device must be used to read the temperature. EZO<sup>™</sup> class pH circuit, has its default temperature set at 25°C. The temperature, at which to compensate against, can be changed at any time using the "T" command.

### Command syntax

(Using an example temperature 19.5)

T,19.5 Where the temperature is any value; floating point, or int, in ASCII form

T,? Query the set temperature

Time until instruction is processed: 300ms

### Device response

T,19.5

After 300ms, an I<sup>2</sup>C read command can be issued to get the response code. A decimal 1 would indicate the command has been successfully processed.



T,?

After 300ms, an I<sup>2</sup>C read command can be issued to get the response

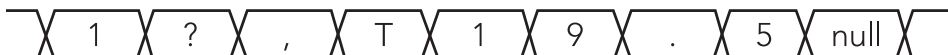

(?T,19.5)

# I<sup>2</sup>C Calibration

The Atlas Scientific EZO™ class pH circuit, has a flexible calibration protocol, allowing for single point, two point or three point calibration.

The only requirement for calibration is that pH 7 calibration must be done first. Calibration can be done at a maximum of 3 points. These three points are known as the low calibration point, the middle calibration point and the high calibration point. Where pH 7.XX must be the first calibration point. This is known as the middle calibration point.

## Command syntax

Cal,clear      Clears all calibration data

Cal,mid,X.XX      Where X.XX is any integer, or floating point value that represents the pH midpoint. In most cases this should be 7.00

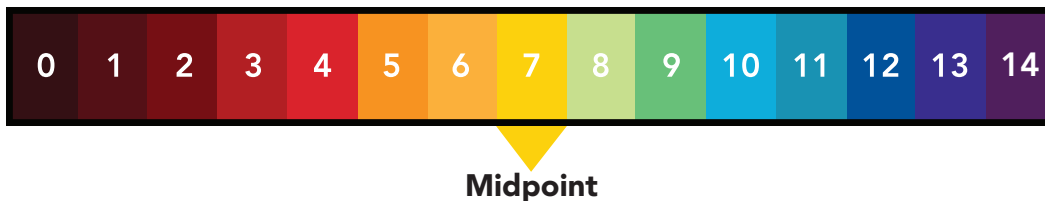

Cal,low,X.XX      Where X.XX is any integer, or floating point value that represents a low calibration point (pH 1 to pH 6)



Cal,high,XX.XX      Where XX.XX is any integer, or floating point value that represents a high calibration point (pH 8 to pH 14)



Cal,?      Query the calibration

## Device response

Cal,clear

The LED will turn **Cyan** during the calibration.

After 300ms, an I<sup>2</sup>C read command can be issued to get the response code.

A decimal 1 would indicate the command has been successfully processed.



Cal,mid,X.XX

The LED will turn **Cyan** during the calibration.

After 1.3 seconds, an I<sup>2</sup>C read command can be issued to get the response code.

A decimal 1 would indicate the command has been successfully processed.



Cal,low, X.XX

The LED will turn **Cyan** during the calibration.

After 1.3 seconds, an I<sup>2</sup>C read command can be issued to get the response code.

A decimal 1 would indicate the command has been successfully processed.



Cal,high, XX.XX

The LED will turn **Cyan** during the calibration.

After 1.3 seconds, an I<sup>2</sup>C read command can be issued to get the response code.

A decimal 1 would indicate the command has been successfully processed.



Cal,?  
After 300ms, an I2C read command can be issued to get the response code.

If not calibrated



(?CAL,0)

If single point calibration



(?CAL,1)

If two point calibration



(?CAL,2)

If three point calibration



(?CAL,3)

Issuing the cal,mid command after the EZO<sup>TM</sup> class pH circuit has been calibrated will clear other calibration points. Full calibration will have to be redone.

Issuing a cal,low or cal,high command can be done at any time and will have no effect on other previously set calibration points.

## I<sup>2</sup>C Device Info

The EZO<sup>TM</sup> class circuit, can identify itself by device type and firmware version. This is done by transmitting the "I" command.

### Command syntax

I Device information

Time until instruction is processed 300 ms

Device response:

After 300ms, an I2C read command can be issued to get the response:



?I,PH,1.0

## Reading the status of the device in I<sup>2</sup>C mode

The Atlas Scientific™ EZO™ class circuit, is able to report its voltage at the VCC pin and the reason the device was last restarted.

### Restart codes

- P** power on reset
- S** software reset
- B** brown out reset
- W** watchdog reset
- U** unknown

### Command syntax

STATUS

Time until instruction is processed, 300ms

### Device response

After 300ms, an I<sup>2</sup>C read command can be issued, to get the response



?STATUS,P,5.038

Where: P is the reason for the last reset event

Where: 5.038 is the its voltage at the VCC



## I<sup>2</sup>C Low power state

To conserve energy in between readings, the Atlas Scientific pH EZO™ class circuit can be put into a low power sleep state. This will turn off the LEDs and shut down almost all of the internal workings of the EZO™ class circuit. The power consumption will be reduced to 1.16 mA at 5V and 0.995 mA at 3.3V. **To wake the EZO™ class circuit, send it any command.**

### Command syntax

SLEEP          Enter low power sleep state  
Time until instruction is processed, 300ms

### Device response

If the LEDs are enabled, the **Blue** LED will blink and then turn off.  
There is no other output associated with this command.

## Switch from I<sup>2</sup>C mode to UART mode

Transmitting the command serial,<n> will set the EZO<sup>TM</sup> class circuit into UART mode from I<sup>2</sup>C mode. **Where [n] represents any of one the 8 available baud rates.**

### Command syntax

(Using as example a baud rate of 9600)

```
SERIAL,9600
```

### Device response

If an incorrect baud rate is sent the device will not switch into UART mode and the **Red** LED will flash.

If a correct baud rate is given:

The **Blue** LED used to indicate that the device is powered and awaiting an instruction will now change to **Green**.

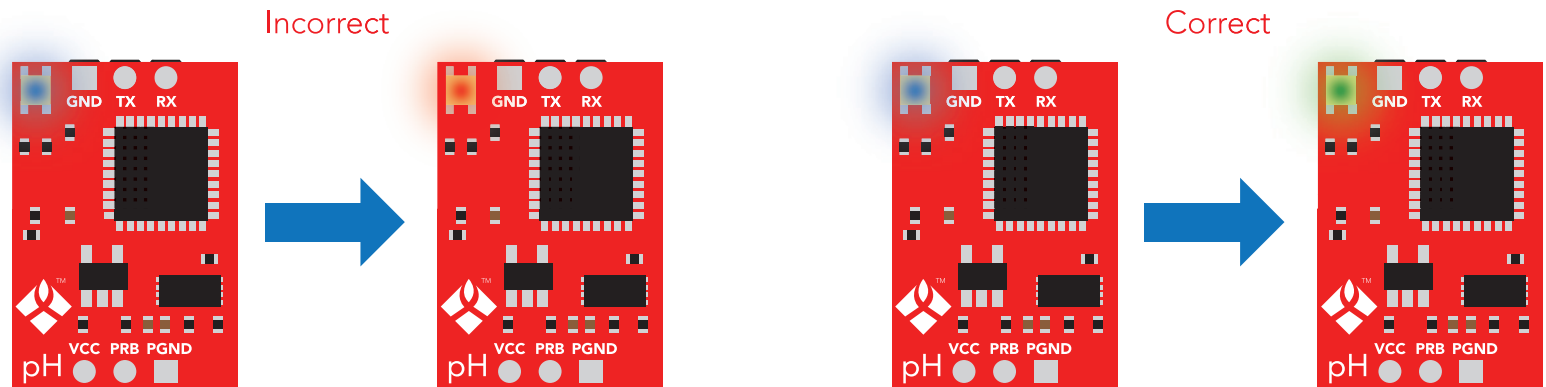

## Factory reset

All EZO<sup>TM</sup> class circuits, are capable of resetting themselves to the original factory settings. Issuing a factory reset will:

- Reset the calibration back to factory default
- Reset default temperature to 25°C
- Set debugging LED to on.
- Enable response codes

**This command will not change the set I<sup>2</sup>C address**

### Command syntax

X     factory reset

### Device response

After 300ms the STATUS command can be issued to see that the device was reset.

?	S	T	A	T	U	S	,	S	,	5	.	0	3	8	null
---	---	---	---	---	---	---	---	---	---	---	---	---	---	---	------

?STATUS,S,5.038

Where: S is the reason for the last reset event (software reset)

Where: 5.038 is the its voltage at the VCC

## Manual switching to UART mode

All EZO<sup>TM</sup> class circuits, can be manually switched from I<sup>2</sup>C mode to UART mode.

**If this is done, the EZO<sup>TM</sup> class pH circuit, will set its baud rate to 38400.**

1. Cut the power to the device
2. Short the right probe pin to the TX pin
3. Power the device
4. Wait for LED to change from **Blue** to **Green**
5. Remove the short from the probe pin to the TX pin
6. Power cycle the device
7. The device is now UART mode

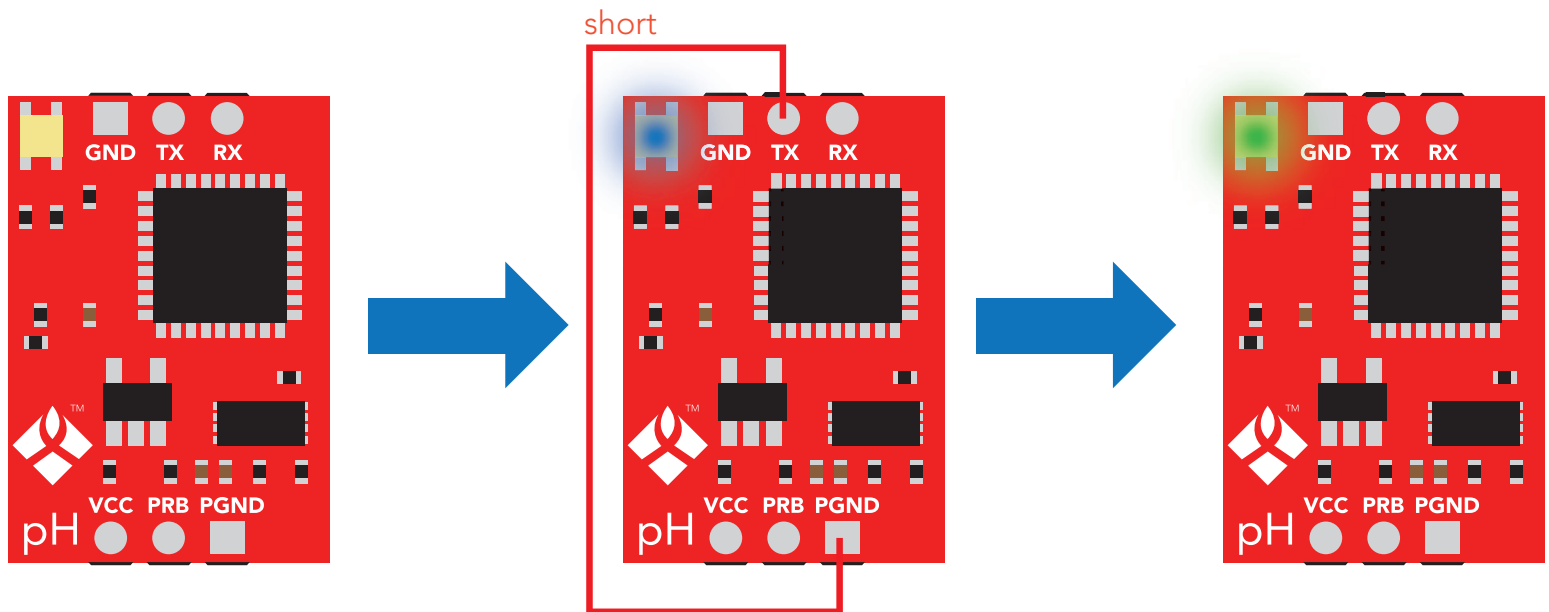

## Circuit dimensions

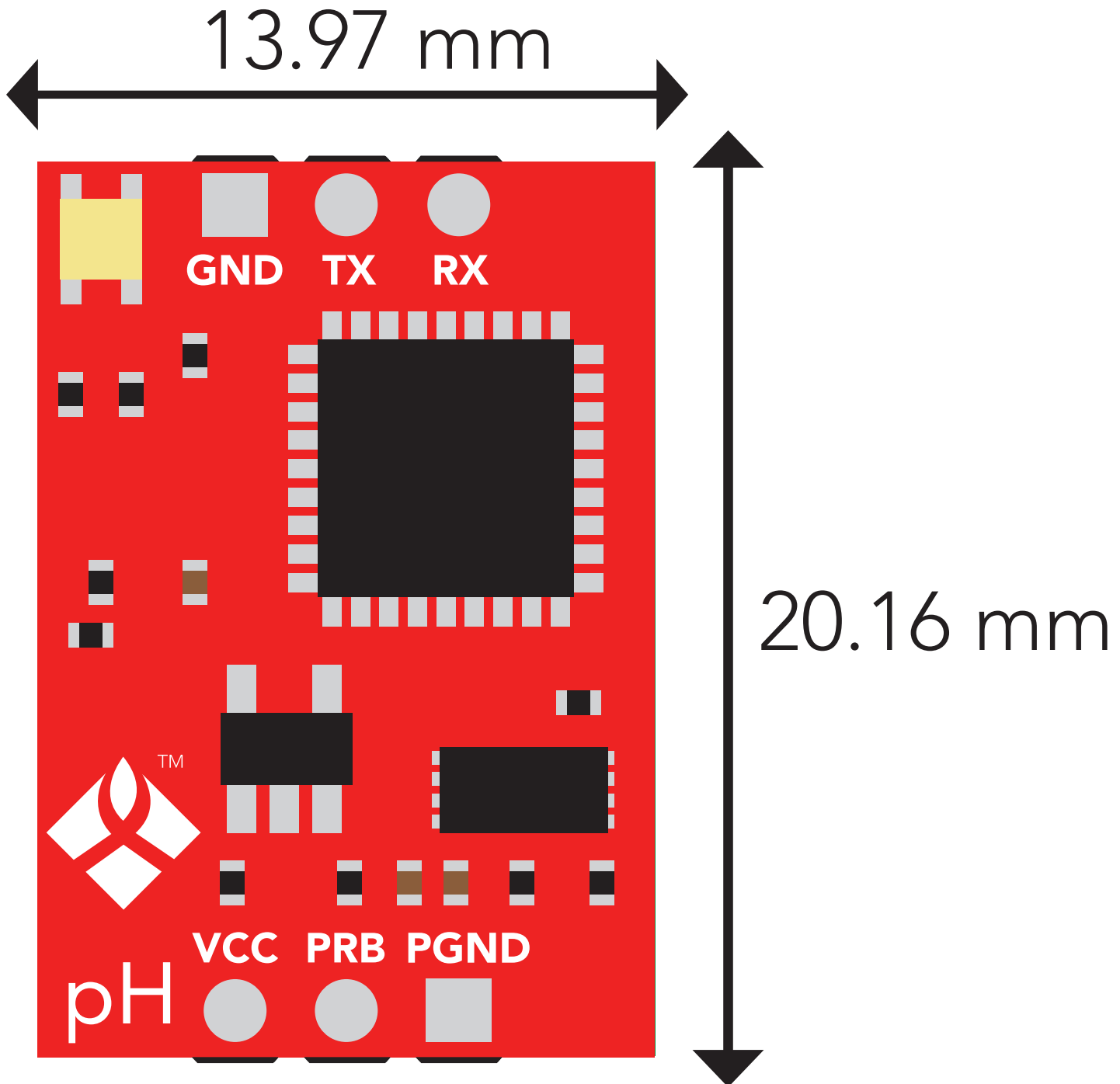

# How to make a footprint for the Atlas Scientific™ EZO™ pH circuit

1. In your CAD software place an 8 position header.



2. Place a 3 position header at both top and bottom of the 8 position header as shown.

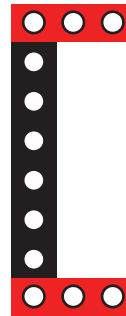

3. Once this is done, you can delete the 8 position header. Make sure that the two 3 position headers are 17.78mm (0.7") apart from each other.

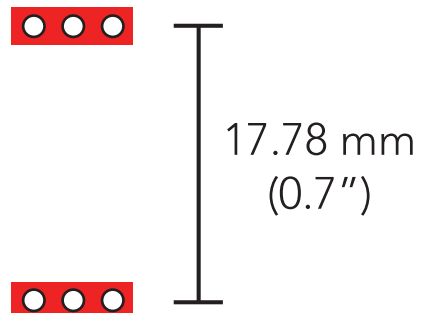

2.54 mm (0.1")

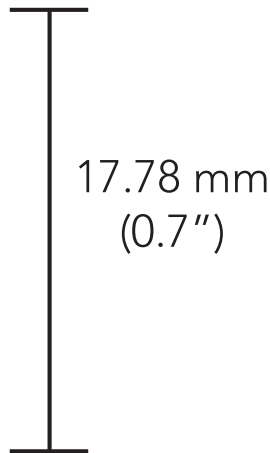
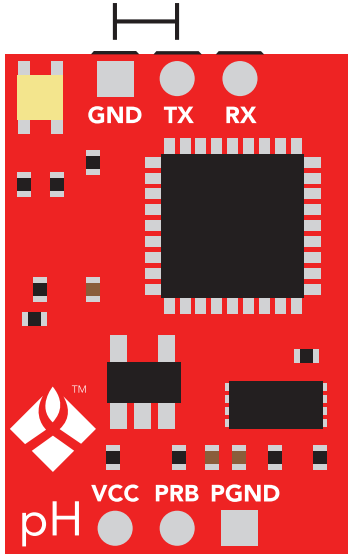

## Wiring diagram

- To connect the Circuit to your microcontroller, follow the diagram below.
- The BNC shield can be connected to any ground line.
- Make sure your Circuit and microcontroller share a common ground.
- TX on your Circuit connects to RX on your microcontroller.
- If in I<sup>2</sup>C mode connect SDA to SDA and SCL to SCL
- \*4.7k pull resistor on SDA and SCL may be required

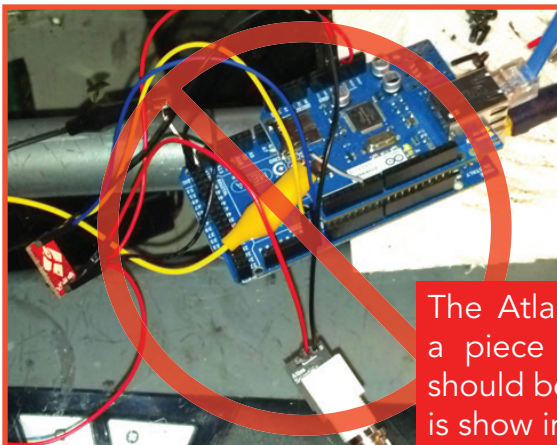
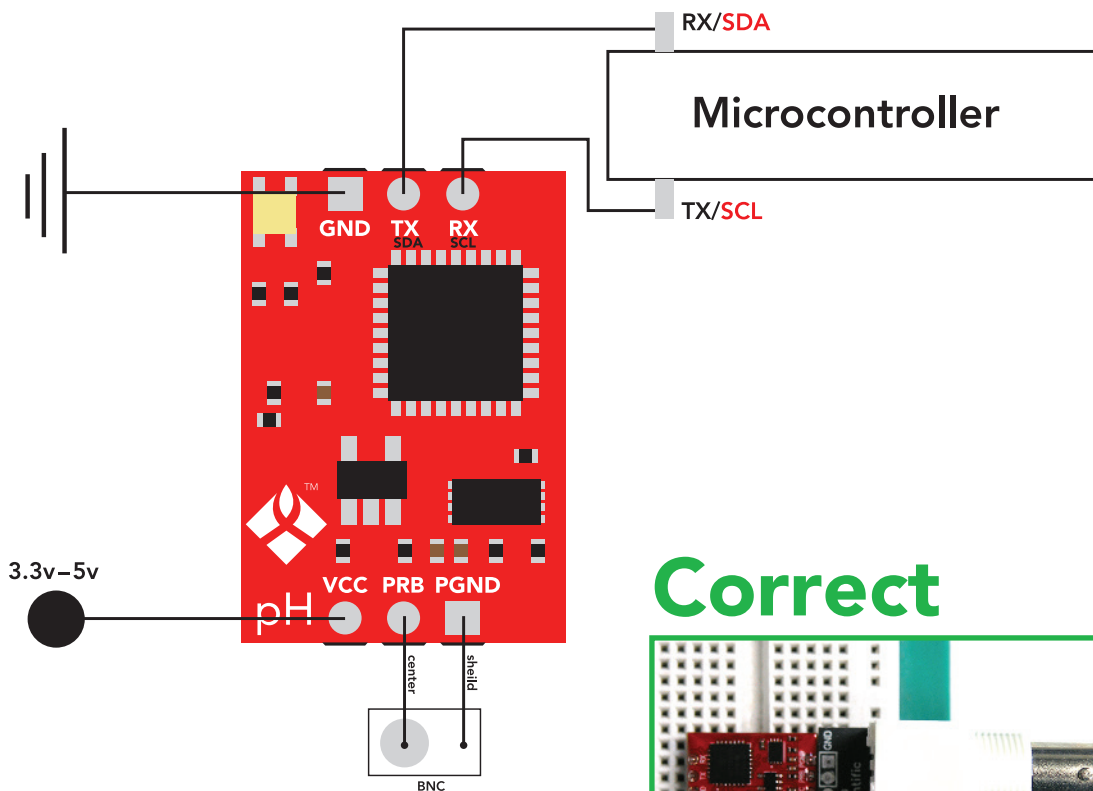

The Atlas Scientific™ EZO™ class pH circuit is a piece of sensitive equipment. Debugging should be done in a bread board; Not like what is show in this photo.

## Correct

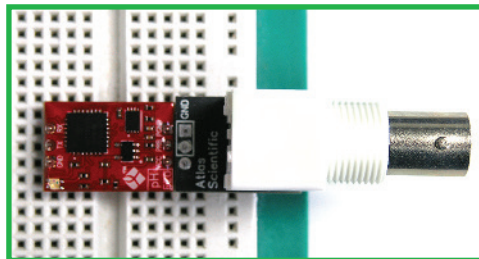

## Incorrect

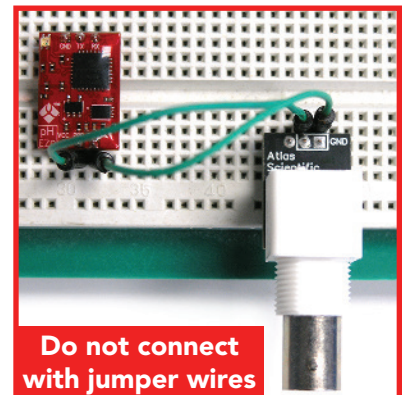

## Warranty

Atlas Scientific™ Warranties the EZO™ class pH circuit to be free of defect during the debugging phase of device implementation, or 30 days after receiving the EZO™ class pH circuit (which ever comes first).

## The debugging phase

The debugging phase as defined by Atlas Scientific™, is the time period when the EZO™ class pH circuit is inserted into a bread board, or shield, and is connected to a microcontroller according to the wiring diagram on pg. 47. Reference this wiring diagram for a connection to USB debugging device, or if a shield is being used, when it is connected to its carrier board.

If the EZO™ class pH circuit is being debugged in a bread board, the bread board must be devoid of other components. If the EZO™ class pH circuit is being connected to a microcontroller, the microcontroller must be running code that has been designed to drive the EZO™ class pH circuit exclusively and output the EZO™ class pH circuit data as a serial string.

**It is important for the embedded systems engineer to keep in mind that the following activities will void the EZO™ class pH circuit warranty:**

- **Soldering any part of the EZO™ class pH circuit**
- **Running any code, that does not exclusively drive the EZO™ class pH circuit and output its data in a serial string**
- **Embedding the EZO™ class pH circuit into a custom made device**
- **Removing any potting compound**



## Reasoning behind this warranty

Because Atlas Scientific<sup>TM</sup> does not sell consumer electronics; once the device has been embedded into a custom made system, Atlas Scientific<sup>TM</sup> cannot possibly warranty the EZO<sup>TM</sup> class pH circuit, against the thousands of possible variables that may cause the EZO<sup>TM</sup> class pH circuit to no longer function properly. Please keep this in mind:

- 1. All Atlas Scientific<sup>TM</sup> devices have been designed to be embedded into a custom made system by you, the embedded systems engineer.**
- 2. All Atlas Scientific<sup>TM</sup> devices have been designed to run indefinitely without failure in the field.**
- 3. All Atlas Scientific<sup>TM</sup> devices can be soldered into place, however you do so at your own risk.**

Atlas Scientific<sup>TM</sup> is simply stating that once the device is being used in your application, Atlas Scientific<sup>TM</sup> can no longer take responsibility for the EZO<sup>TM</sup> class pH circuits continued operation. This is because that would be equivalent to Atlas Scientific<sup>TM</sup> taking responsibility over the correct operation of your entire device.





TM