

V_{DSS}	-30V
$R_{DS(on)}(Max.)$	1.4Ω
I_D	±0.2A
P_D	0.15W

●Features

- 1) Low on-resistance.
- 2) Small package(EMT3)
- 3) 4V drive
- 4) Lead Free/RoHS Compliant.

●Application

Switching

●Absolute maximum ratings ($T_a = 25^{\circ}C$)

Parameter	Symbol	Value	Unit
Drain - Source voltage	V_{DSS}	-30	V
Continuous drain current	I_D	±0.2	A
Pulsed drain current	$I_{D,pulse}^{*1}$	±0.4	A
Gate - Source voltage	V_{GSS}	±20	V
Power dissipation	P_D^{*2}	0.15	W
Junction temperature	T_j	150	°C
Range of storage temperature	T_{stg}	-55 to +150	°C

●Thermal resistance

Parameter	Symbol	Value	Unit
junction - ambient	$R_{th(ch-a)}^{*2}$	833	°C/W

●Outline

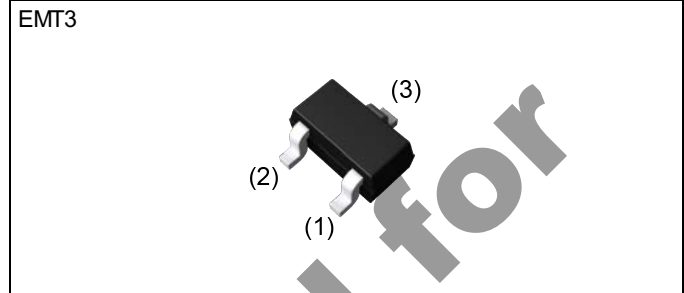

●Inner circuit

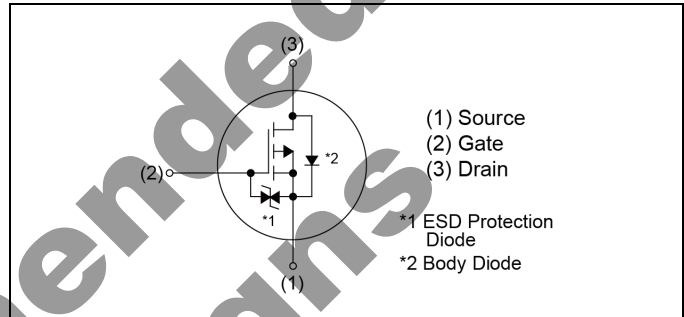

●Packaging specifications

Type	Packing	Embossed Tape
	Reel size (mm)	180
	Tape width (mm)	8
	Basic ordering unit (pcs)	3000
	Taping code	TL
	Marking	WP

●Electrical characteristics (T_a = 25°C)

Parameter	Symbol	Conditions	Values			Unit
			Min.	Typ.	Max.	
Drain - Source breakdown voltage	V _{(BR)DSS}	V _{GS} = 0V, I _D = -1mA	-30	-	-	V
Zero gate voltage drain current	I _{DSS}	V _{DS} = -30V, V _{GS} = 0V	-	-	-1	μA
Gate - Source leakage current	I _{GSS}	V _{GS} = ±20V, V _{DS} = 0V	-	-	±10	μA
Gate threshold voltage	V _{GS(th)}	V _{DS} = -10V, I _D = -1mA	-1.0	-	-2.5	V
Static drain - source on - state resistance	R _{DS(on)} ^{*3}	V _{GS} = -10V, I _D = -0.2A	-	0.9	1.4	Ω
		V _{GS} = -4.5V, I _D = -0.15A	-	1.4	2.1	
		V _{GS} = -4.0V, I _D = -0.15A	-	1.6	2.4	
Transconductance	g _{fs} ^{*3}	V _{DS} = -10V, I _D = -0.15A	0.2	-	-	S
Input capacitance	C _{iss}	V _{GS} = 0V	-	30	-	pF
Output capacitance	C _{oss}	V _{DS} = -10V	-	4	-	
Reverse transfer capacitance	C _{rss}	f = 1MHz	-	5	-	
Turn - on delay time	t _{d(on)} ^{*3}	V _{DD} = -15V, V _{GS} = -10V	-	8	-	ns
Rise time	t _r ^{*3}	I _D = 0.15A	-	5	-	
Turn - off delay time	t _{d(off)} ^{*3}	R _L = 100Ω	-	30	-	
Fall time	t _f ^{*3}	R _G = 10Ω	-	40	-	

●Body diode electrical characteristics (Source-Drain) (T_a = 25°C)

Parameter	Symbol	Conditions	Values			Unit
			Min.	Typ.	Max.	
Forward voltage	V _{SD} ^{*3}	V _{GS} = 0V, I _S = -0.1A	-	-	-1.2	V

*1 P_w ≤ 10μs, Duty cycle ≤ 1%

*2 Each terminal mounted on a recommended land

*3 Pulsed

● Electrical characteristic curves

Fig.1 Typical Capacitance vs. Drain - Source Voltage

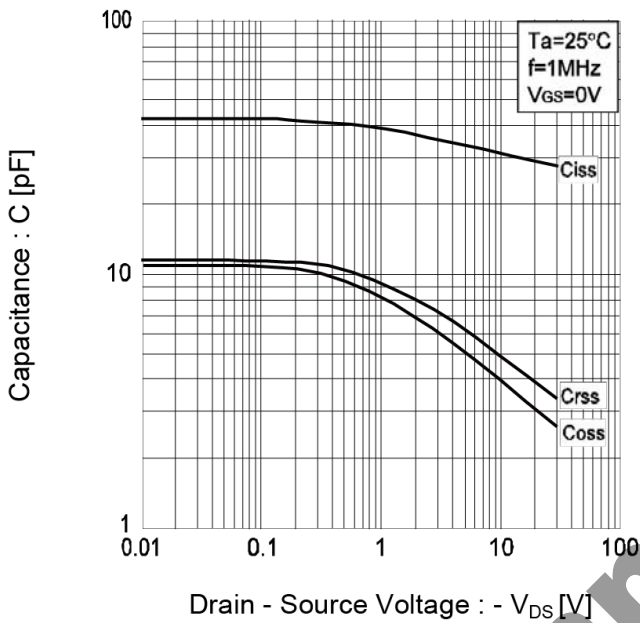

Fig.2 Switching Characteristics

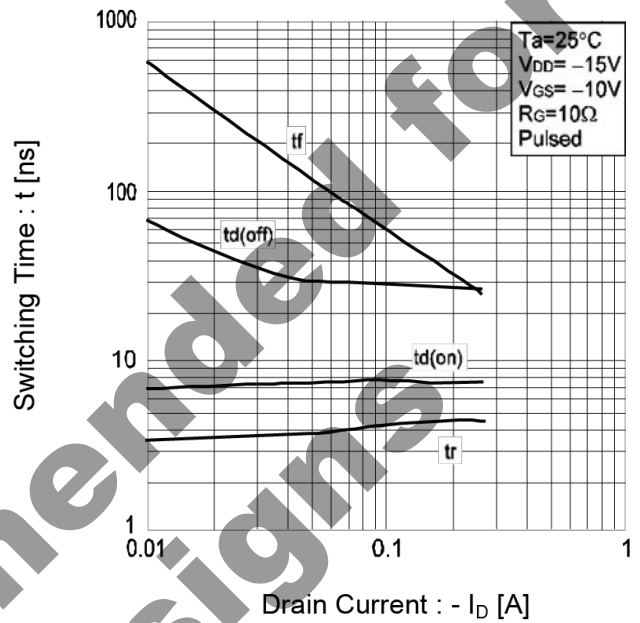

Fig.3 Dynamic Input Characteristics

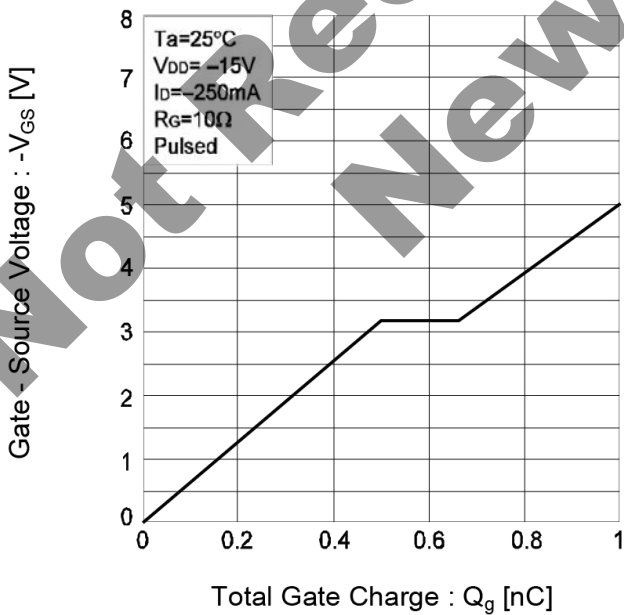
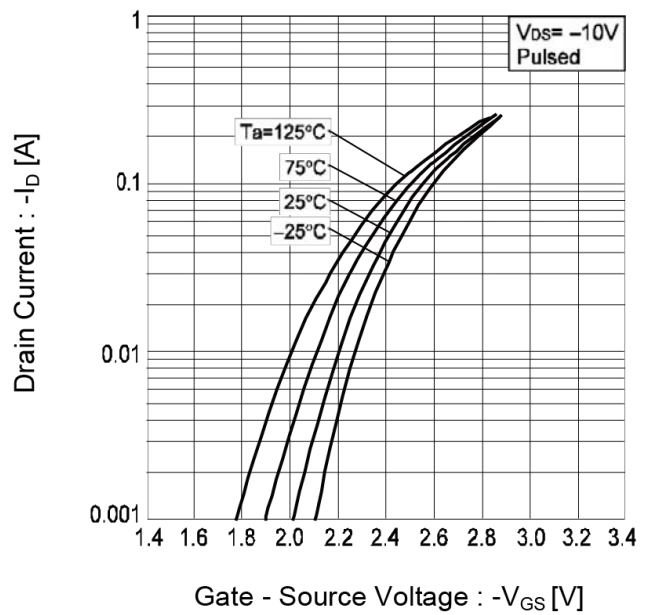

Fig.4 Typical Transfer Characteristics



●Electrical characteristic curves

Fig.5 Static Drain - Source On - State Resistance vs. Gate Source Voltage

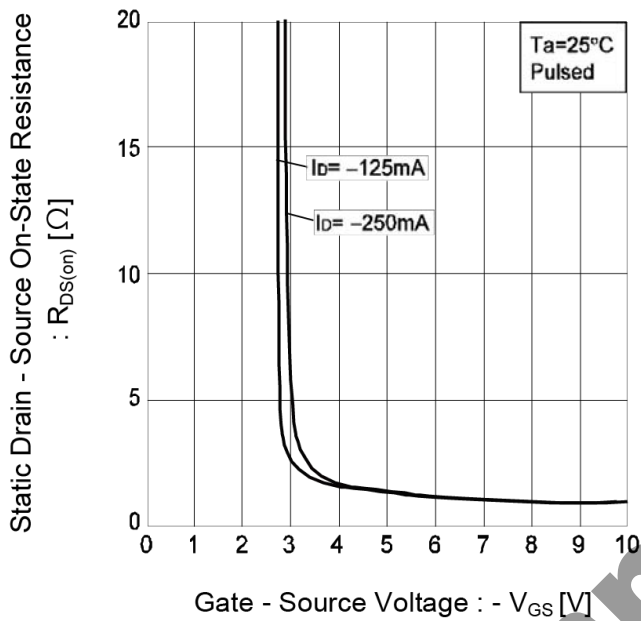

Fig.6 Reverse Drain Current vs. Source-Drain Voltage

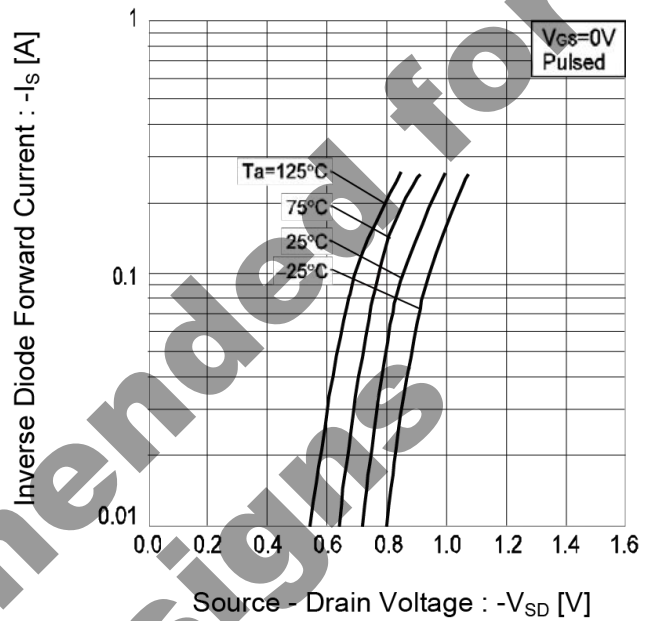

Fig.7 Static Drain - Source On - State Resistance vs. Drain Current (I)

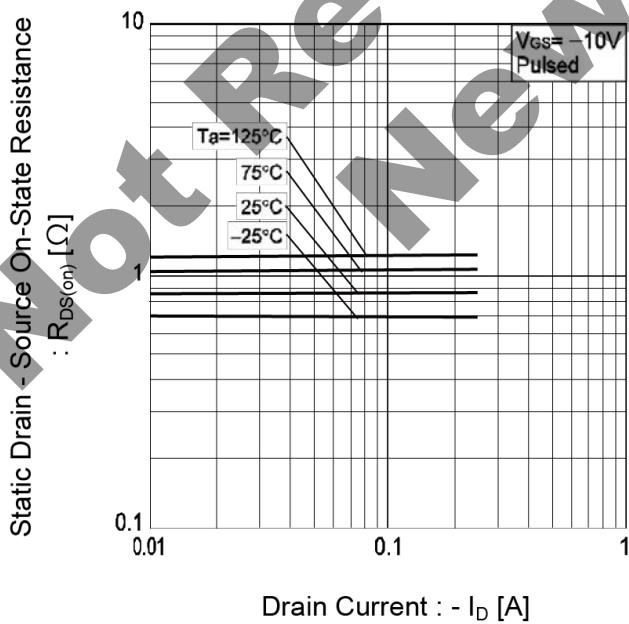
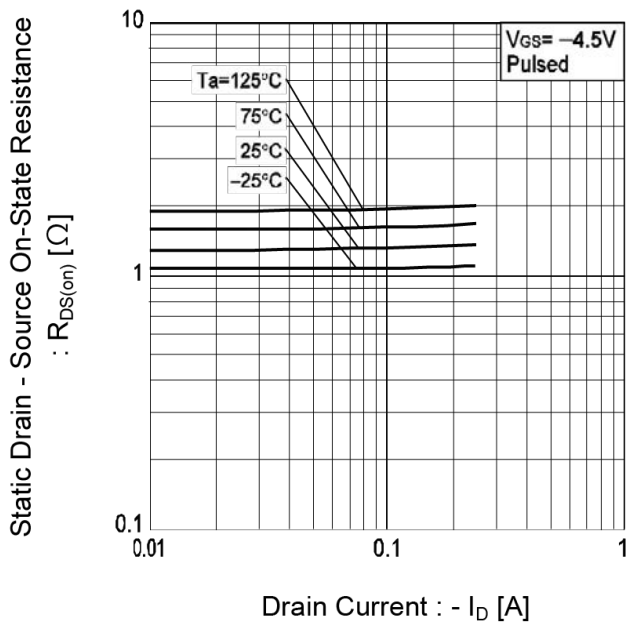

Fig.8 Static Drain - Source On - State Resistance vs. Drain Current (II)



● Electrical characteristic curves

Fig.9 Static Drain - Source On - State Resistance vs. Drain Current (III)

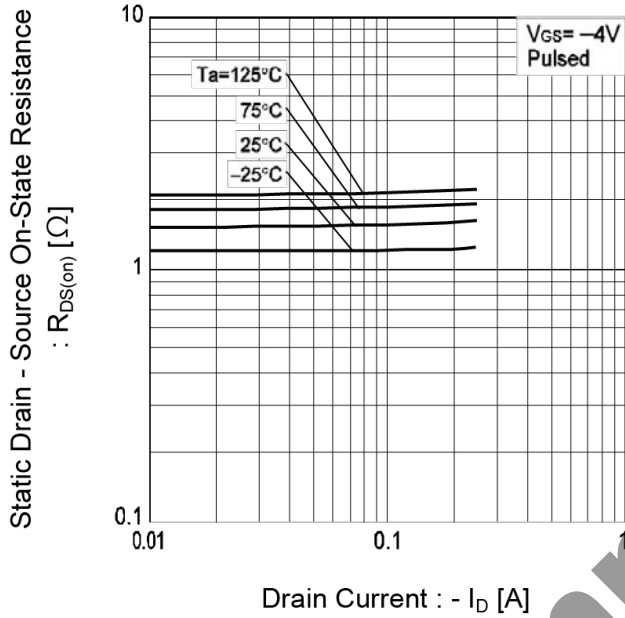
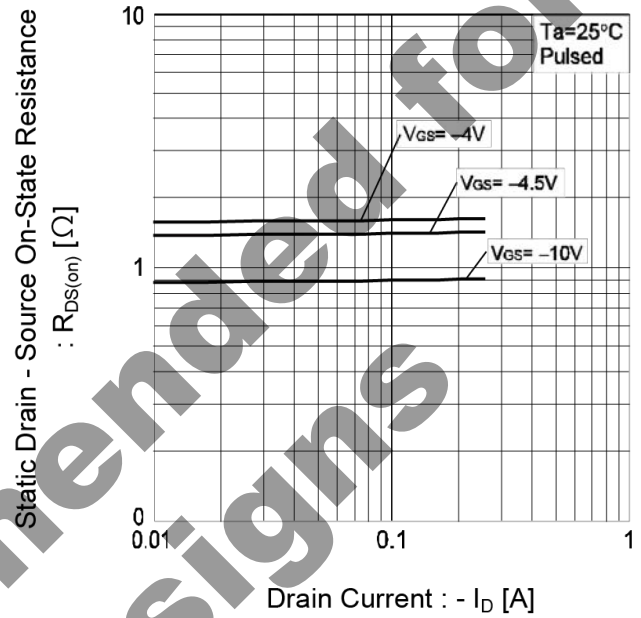

Fig.10 Static Drain - Source On - State Resistance vs. Drain Current (IV)



Not Recommended for New Designs

● Measurement circuits

Fig.1-1 Switching Time Measurement Circuit

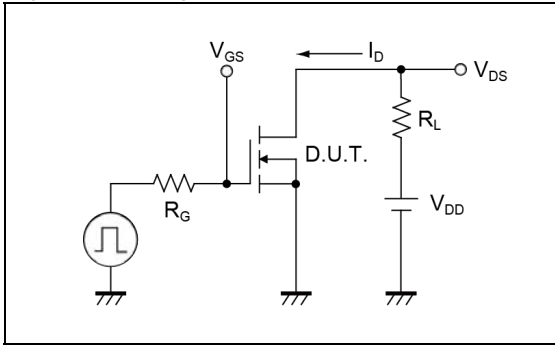
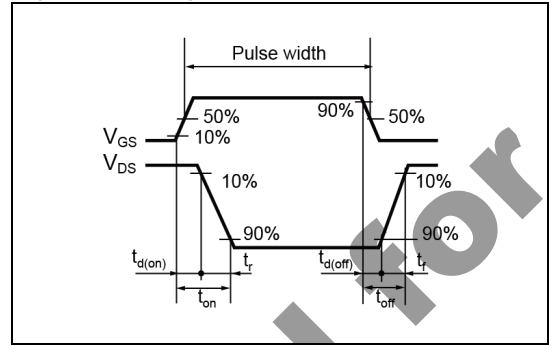

Fig.1-2 Switching Waveforms



Not Recommended for New Designs

●Dimensions

EMT3

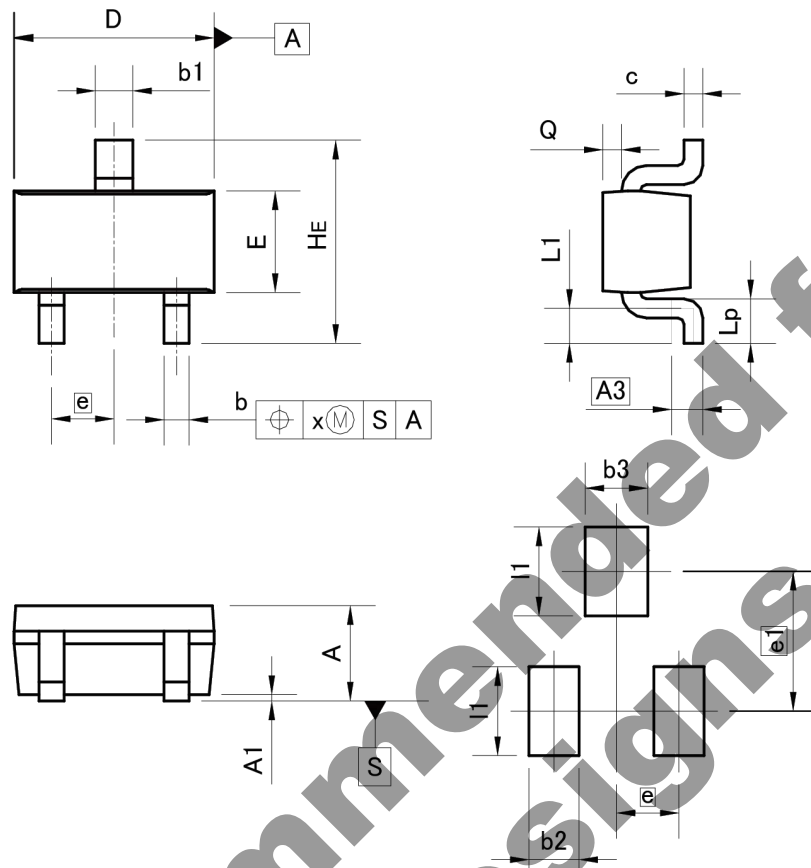

Pattern of terminal position areas
[Not a recommended pattern of soldering pads]

DIM	MILIMETERS		INCHES	
	MIN	MAX	MIN	MAX
A	0.60	0.80	0.024	0.031
A1	0.00	0.10	0.000	0.004
A3	0.25		0.010	
b	0.15	0.30	0.006	0.012
b1	0.25	0.40	0.010	0.016
c	0.10	0.20	0.004	0.008
D	1.50	1.70	0.059	0.067
E	0.70	0.90	0.028	0.035
e	0.50		0.020	
HE	1.40	1.80	0.055	0.071
L1	0.10	-	0.004	-
Lp	0.15	-	0.006	-
Q	0.05	0.25	0.002	0.010
x	-	0.10	-	0.004

DIM	MILIMETERS		INCHES	
	MIN	MAX	MIN	MAX
b2	-	0.40	-	0.016
b3	-	0.50	-	0.020
e1	1.10		0.043	
I1	-	0.70	-	0.028

Dimension in mm/inches

Notes

- 1) The information contained herein is subject to change without notice.
- 2) Before you use our Products, please contact our sales representative and verify the latest specifications :
- 3) Although ROHM is continuously working to improve product reliability and quality, semiconductors can break down and malfunction due to various factors. Therefore, in order to prevent personal injury or fire arising from failure, please take safety measures such as complying with the derating characteristics, implementing redundant and fire prevention designs, and utilizing backups and fail-safe procedures. ROHM shall have no responsibility for any damages arising out of the use of our Products beyond the rating specified by ROHM.
- 4) Examples of application circuits, circuit constants and any other information contained herein are provided only to illustrate the standard usage and operations of the Products. The peripheral conditions must be taken into account when designing circuits for mass production.
- 5) The technical information specified herein is intended only to show the typical functions of and examples of application circuits for the Products. ROHM does not grant you, explicitly or implicitly, any license to use or exercise intellectual property or other rights held by ROHM or any other parties. ROHM shall have no responsibility whatsoever for any dispute arising out of the use of such technical information.
- 6) The Products are intended for use in general electronic equipment (i.e. AV/OA devices, communication, consumer systems, gaming/entertainment sets) as well as the applications indicated in this document.
- 7) The Products specified in this document are not designed to be radiation tolerant.
- 8) For use of our Products in applications requiring a high degree of reliability (as exemplified below), please contact and consult with a ROHM representative : transportation equipment (i.e. cars, ships, trains), primary communication equipment, traffic lights, fire/crime prevention, safety equipment, medical systems, servers, solar cells, and power transmission systems.
- 9) Do not use our Products in applications requiring extremely high reliability, such as aerospace equipment, nuclear power control systems, and submarine repeaters.
- 10) ROHM shall have no responsibility for any damages or injury arising from non-compliance with the recommended usage conditions and specifications contained herein.
- 11) ROHM has used reasonable care to ensure the accuracy of the information contained in this document. However, ROHM does not warrants that such information is error-free, and ROHM shall have no responsibility for any damages arising from any inaccuracy or misprint of such information.
- 12) Please use the Products in accordance with any applicable environmental laws and regulations, such as the RoHS Directive. For more details, including RoHS compatibility, please contact a ROHM sales office. ROHM shall have no responsibility for any damages or losses resulting non-compliance with any applicable laws or regulations.
- 13) When providing our Products and technologies contained in this document to other countries, you must abide by the procedures and provisions stipulated in all applicable export laws and regulations, including without limitation the US Export Administration Regulations and the Foreign Exchange and Foreign Trade Act.
- 14) This document, in part or in whole, may not be reprinted or reproduced without prior consent of ROHM.



Thank you for your accessing to ROHM product informations.
More detail product informations and catalogs are available, please contact us.

ROHM Customer Support System

<http://www.rohm.com/contact/>