

10	9	8	7	6	5	4	3	2	1
LC QUAD ADAPTER	LC QUAD ADAPTER	SPLIT SLEEVE							
P/N	COLOR	MATERIAL							
106123-0400	BLUE	ZR							
106123-1400	BEIGE	PHOSPHOR BRONZE							
106123-2400	GREEN	ZR							
106123-3400	AQUA	PHOSPHOR BRONZE							

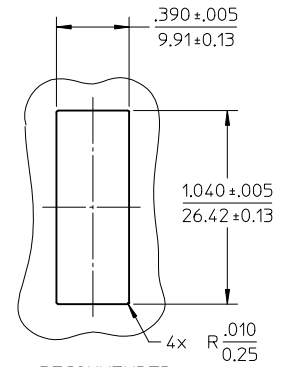

RECOMMENDED MOUNTING PATTERN
SCALE 15:1

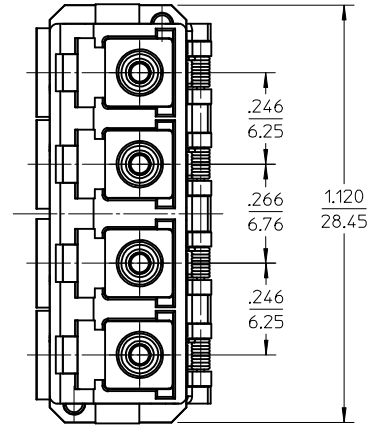
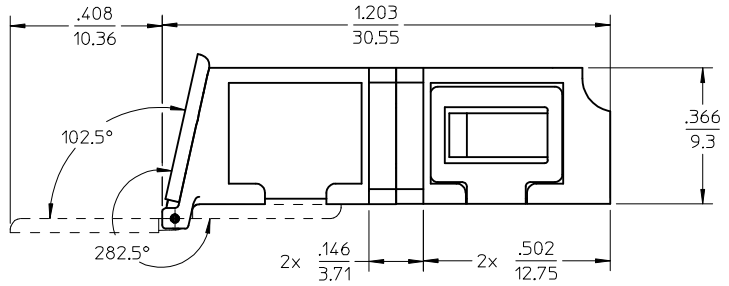
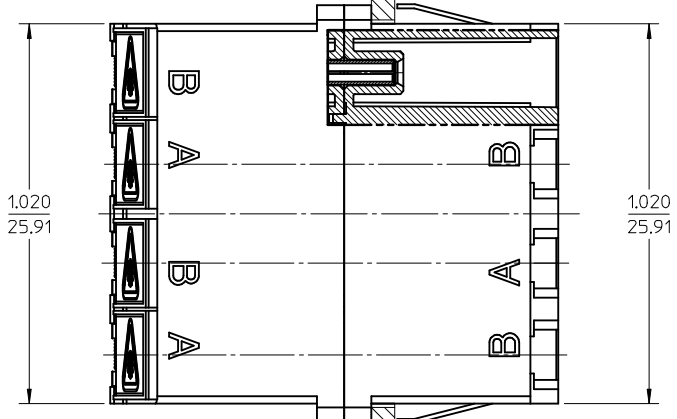
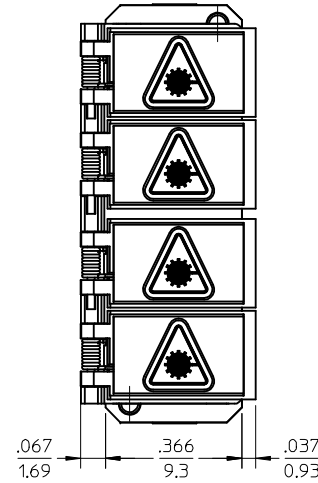
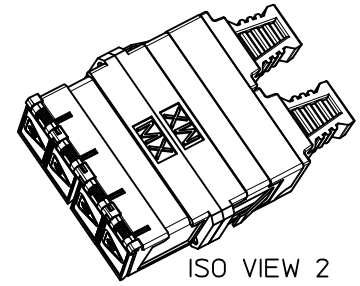

ISO VIEW 2
SCALE 15:1

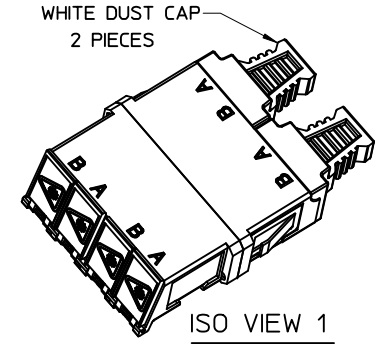

ISO VIEW 1
SCALE 15:1

WHITE DUST CAP
2 PIECES

- NOTES:
- ALL DIMENSIONS ARE FOR REFERENCE.
 - DUST CAPS NOT SHOWN ON FRONT, BOTTOM AND RIGHT VIEW.
 - LC QUAD ADAPTER HAS SC DUPLEX ADAPTER FOOTPRINT.

ENTER DESCRIPTION EC NO: MF2013-0549 DRAWN: KPEVZNER 2013/03/06 CHKD: APPR: IGUMIN 2013/03/07 A1	QUALITY SYMBOLS ▽/0 ▽/0 ▽/0	GENERAL TOLERANCES (UNLESS SPECIFIED)		DIMENSION STYLE IN/MM		SCALE 3:1	DESIGN UNITS INCH	THIRD ANGLE PROJECTION	
		4 PLACES ± --- ± ---	3 PLACES ± --- ± ---	2 PLACES ± --- ± ---	1 PLACE ± --- ± ---	0 PLACE ± ±	DRAWN BY PGIBLIN	DATE 2005/11/21	TITLE LC QUAD ADAPTER WITH SHUTTERS SMALL FLANGE, SNAP MOUNT molex
		ANGULAR ± --- ° DRAFT WHERE APPLICABLE MUST REMAIN WITHIN DIMENSIONS					CHECKED BY	DATE	
							APPROVED BY	DATE	SHEET NO. 1 OF 1

THIS DRAWING CONTAINS INFORMATION THAT IS PROPRIETARY TO MOLEX INCORPORATED AND SHOULD NOT BE USED WITHOUT WRITTEN PERMISSION