

- NOTES:
- MATERIAL:
'A' = NYLON V-0 LOW HALOGEN; COLOR: BLACK
'B' = NYLON V-2 GLOW WIRE CAPABLE; COLOR: BLACK
'C' = NYLON V-2; COLOR: BLACK
 - FINISH: NONE
 - PRODUCT SPECIFICATION: PS-172718-0000 and 2029880001-PS
APPLICATION SPECIFICATION: AS-172718-0000
 - PACKAGING SPECIFICATION: BULK
PK-172708-0000
 - THIS PART TO BE USED WITH FEMALE TERMINAL SERIES 172718, 202988 AND TPA SERIES 172709.
 - THIS PART MATES WITH SERIES 5559, 5566, 5569, 172762 AND 172767.
 - THIS PART CONFORMS TO CLASS 'B' REQUIREMENTS OF COSMETIC SPECIFICATION PS-45499-002.
 - THIS PRODUCT MUST BE USED WITH THE TPA INSTALLED.
 - SEE DRAWING SD-172709-0000 AND 1727090001-SD FOR OTHER TPA INFORMATION.
 - SEE DRAWINGS SD-172718-0000 and 2029880001-PSD FOR OTHER CRIMP TERMINAL INFORMATION.

THIS DRAWING CONTAINS INFORMATION THAT IS PROPRIETARY TO MOLEX ELECTRONIC TECHNOLOGIES, LLC AND SHOULD NOT BE USED WITHOUT WRITTEN PERMISSION									
DIMENSION UNITS	SCALE	CURRENT REV DESC: NEW TPA UPDT S1 & S2							
mm	5:1	molex HOUSING, DUAL ROW RECEPTACLE MINI-FIT TPA2							
GENERAL TOLERANCES (UNLESS SPECIFIED)									
ANGULAR TOL	± °	EC NO: 178886							
4 PLACES	±	DRWN: VNANDAM	2018/06/25						
3 PLACES	±	CHK'D: SGANGADHARDO	2018/07/20						
2 PLACES	± 0.13	APPR: ISHWARG	2018/07/23						
1 PLACE	± 0.2	INITIAL REVISION:							
0 PLACES	±	DRWN: TGREGORI	2014/09/10						
DRAFT WHERE APPLICABLE MUST REMAIN WITHIN DIMENSIONS		APPR: RHODGE	2014/12/04						
THIRD ANGLE PROJECTION		DRAWING	SERIES	DOCUMENT NUMBER: SD-172708-0000 DOC TYPE: PSD DOC PART: 000 REVISION: H4					
C-SIZE		172708	MATERIAL NUMBER: SEE TABLE		CUSTOMER: GENERAL MARKET			SHEET NUMBER: 1 OF 4	

PART NUMBER	CKTS	DIM C	DIM D	MATERIAL
172708-0002	2	8.00	11.80	A
172708-0102				B
172708-0202				C
172708-0004	4	9.60	13.40	A
172708-0104				B
172708-0204				C
172708-0006	6	13.80	17.60	A
172708-0106				B
172708-0206				C
172708-0008	8	18.00	21.80	A
172708-0108				B
172708-0208				C
172708-0010	10	22.20	26.00	A
172708-0110				B
172708-0210				C
172708-0012	12	26.40	30.20	A
172708-0112				B
172708-0212				C

POLARIZATION DETAIL

SHOWN WITHOUT TPA OR TERMINAL FOR CLARITY

2 CKT

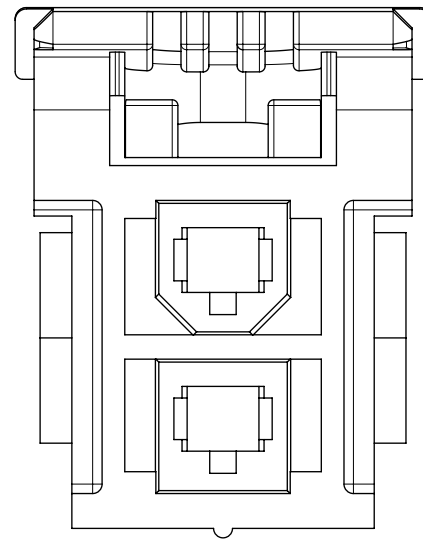

8 CKT

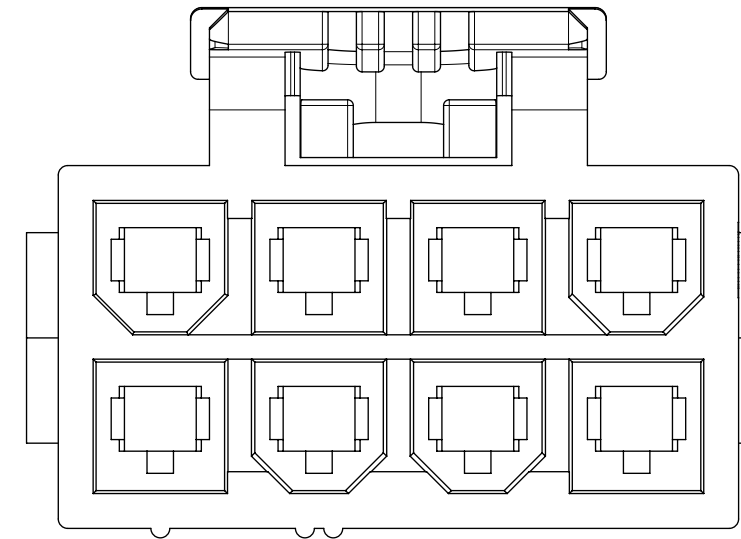

4 CKT

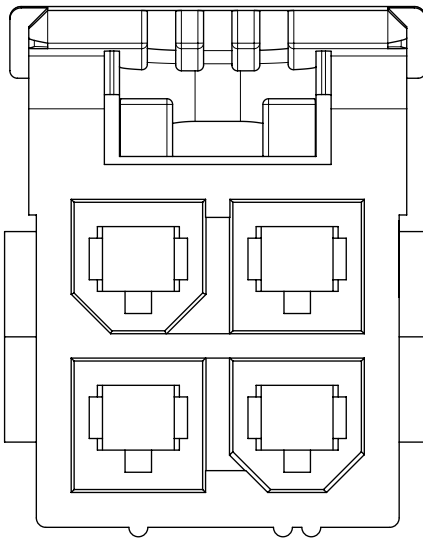

10 CKT

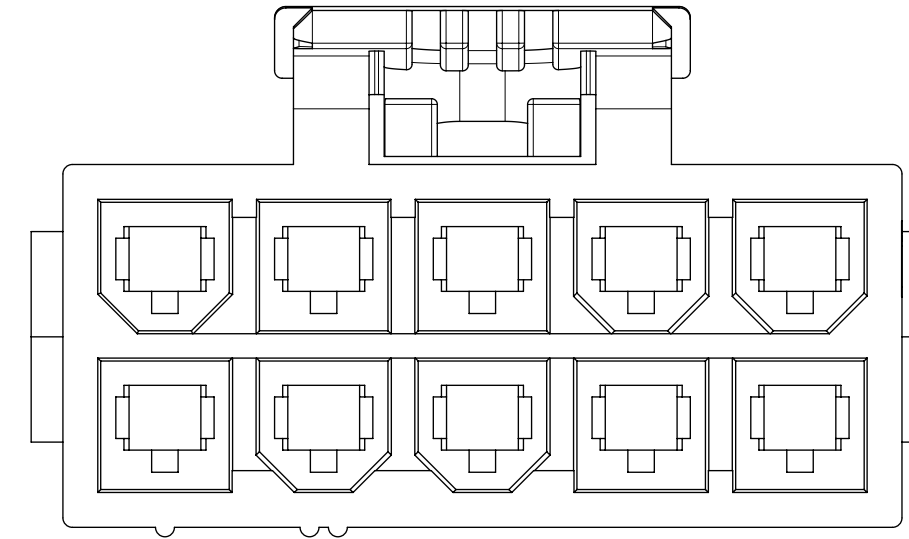

6 CKT

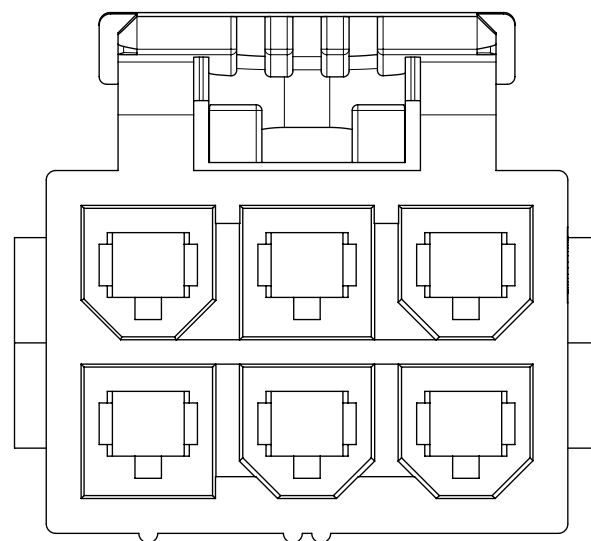

12 CKT

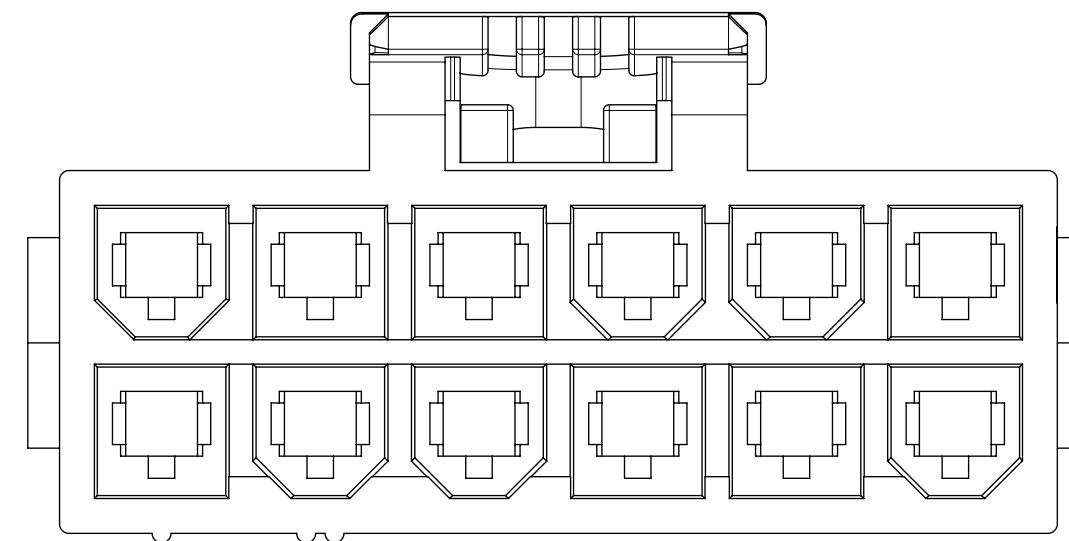

THIS DRAWING CONTAINS INFORMATION THAT IS PROPRIETARY TO MOLEX ELECTRONIC TECHNOLOGIES, LLC AND SHOULD NOT BE USED WITHOUT WRITTEN PERMISSION											
DIMENSION UNITS		SCALE		CURRENT REV DESC: NEW TPA UPDT S1 & S2						molex	
mm		5:1									
GENERAL TOLERANCES (UNLESS SPECIFIED)				EC NO: 178886						HOUSING, DUAL ROW RECEPTACLE MINI-FIT TPA2	
ANGULAR TOL ± °				DRWN: VNANDAM 2018/06/25							
4 PLACES ±				CHK'D: SGANGADHARDO 2018/07/20							
3 PLACES ±				APPR: ISHWARG 2018/07/23						PRODUCT CUSTOMER DRAWING	
2 PLACES ± 0.13				INITIAL REVISION:						DOCUMENT NUMBER	
1 PLACE ± 0.2				DRWN: TGREGORI 2014/09/10						SD-172708-0000	
0 PLACES ±				APPR: RHODGE 2014/12/04						DOC TYPE DOC PART REVISION	
DRAFT WHERE APPLICABLE MUST REMAIN WITHIN DIMENSIONS				THIRD ANGLE PROJECTION		DRAWING		SERIES		MATERIAL NUMBER	
						C-SIZE		172708		SEE TABLE	
DOCUMENT STATUS				P1		RELEASE DATE		2018/07/26 06:10:10		CUSTOMER	
										GENERAL MARKET	
										SHEET NUMBER	
										2 OF 4	

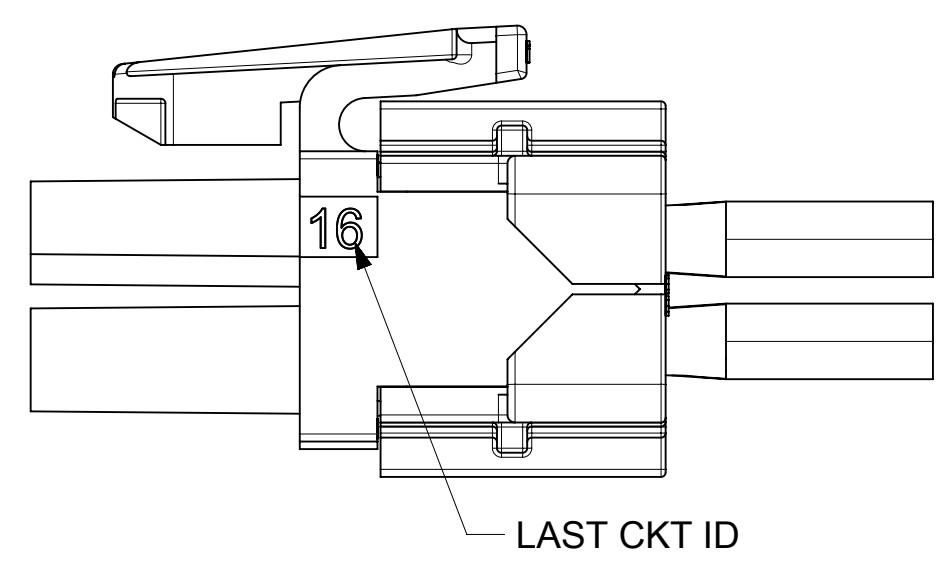
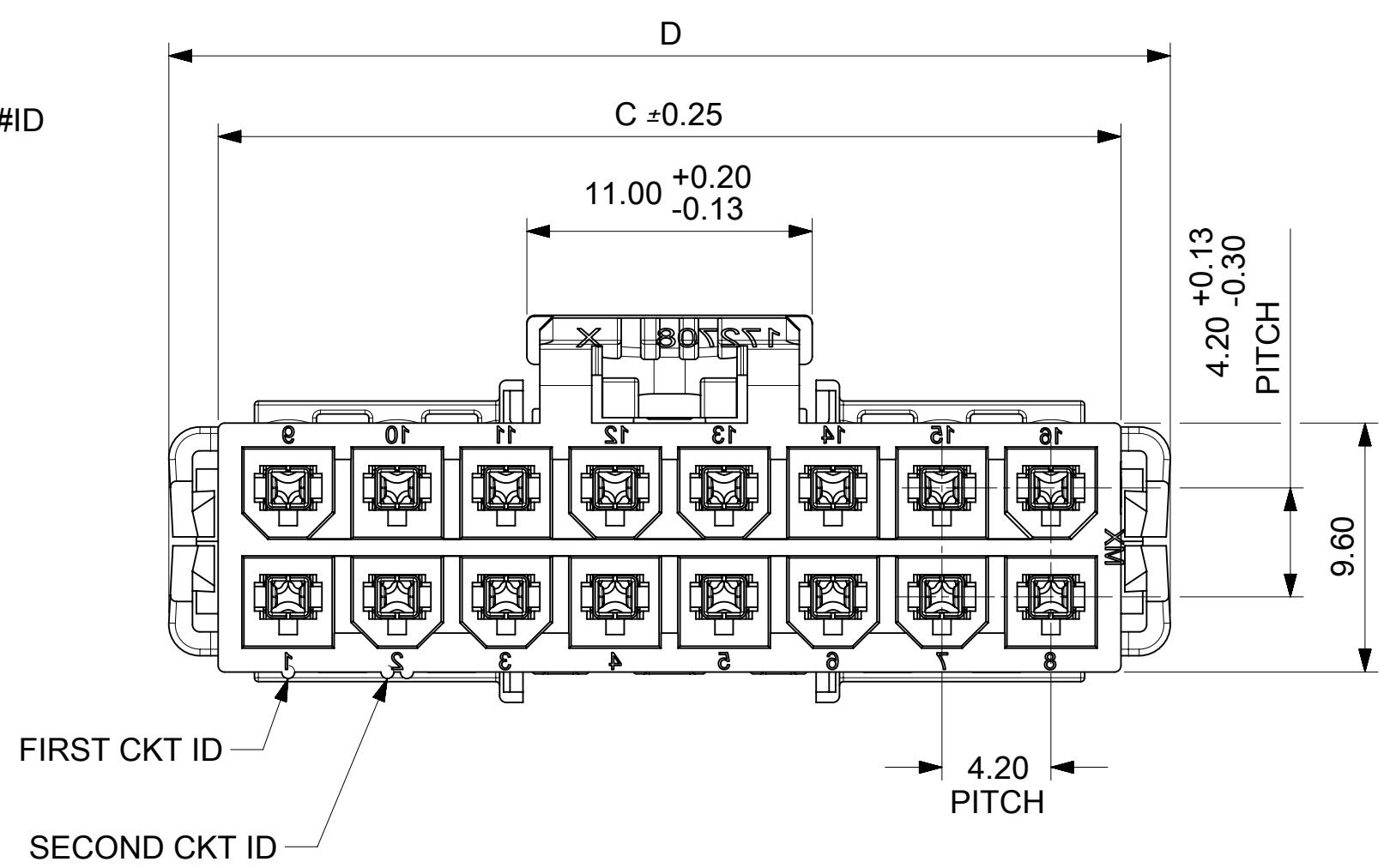
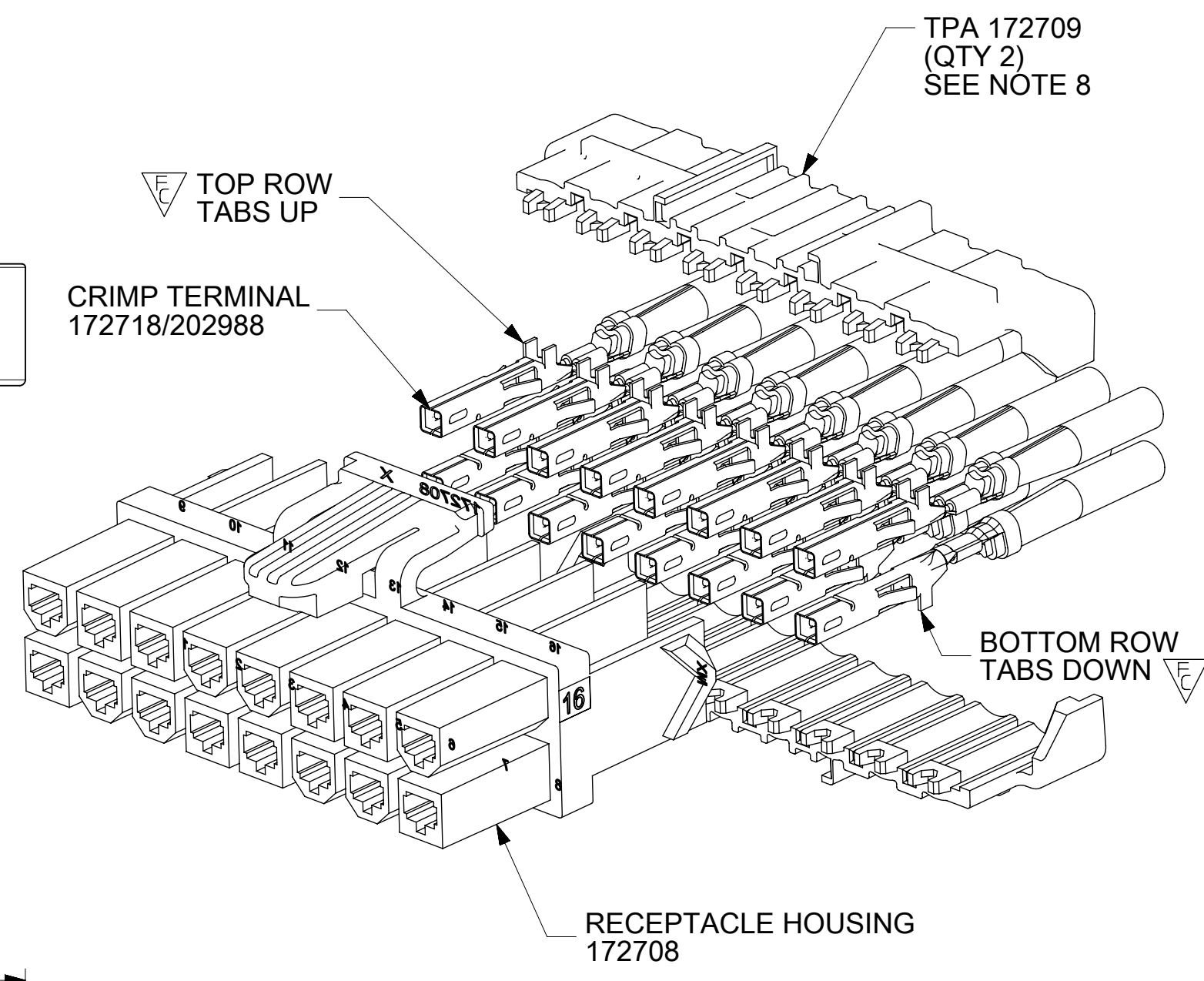
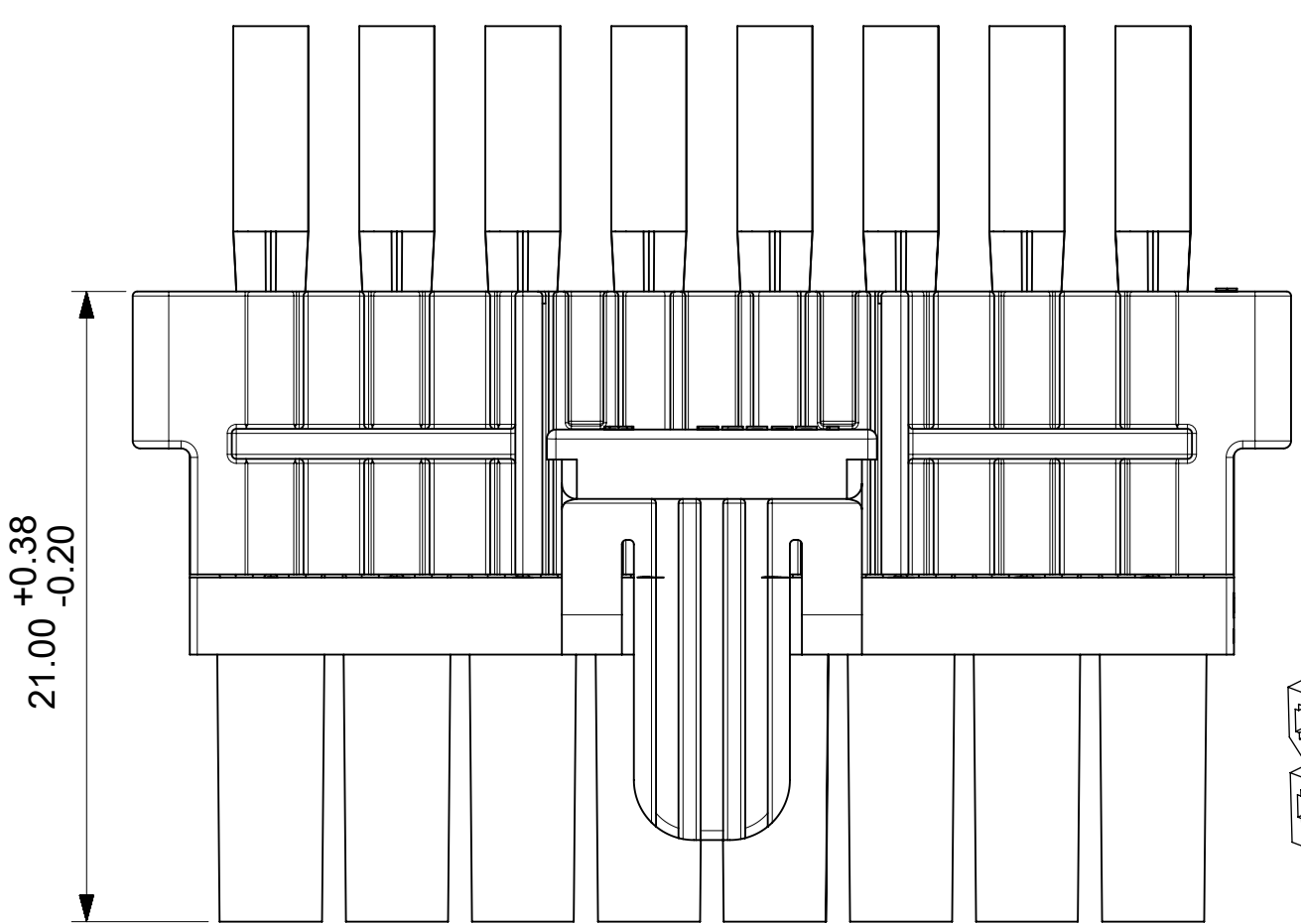
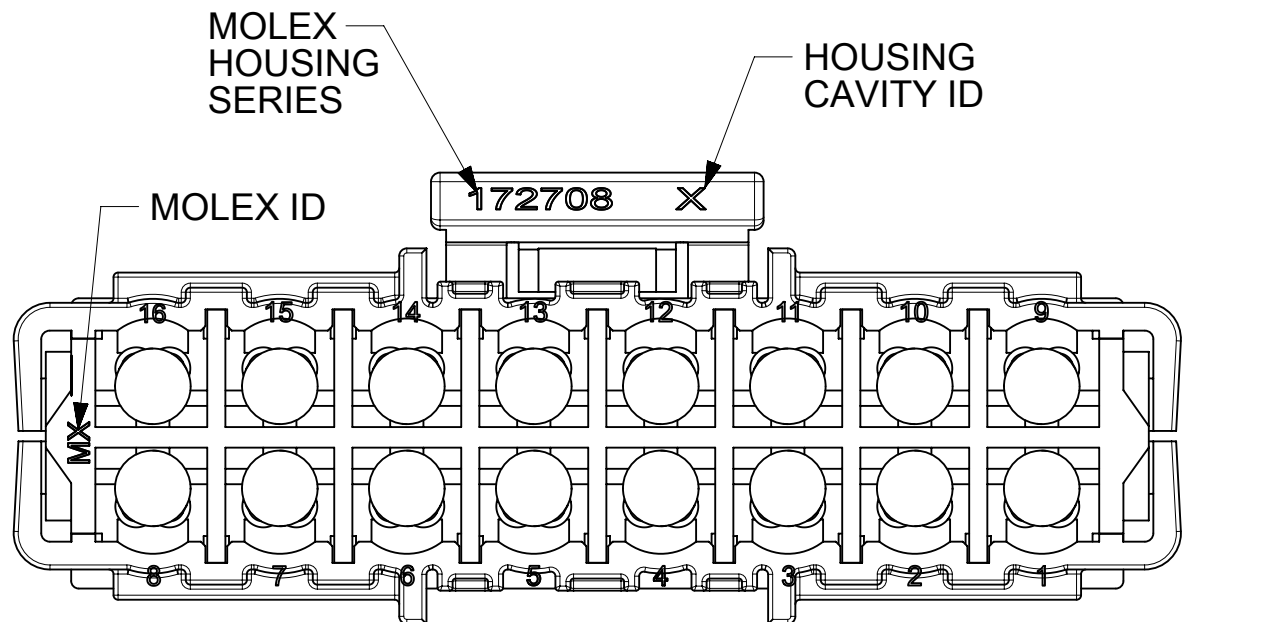
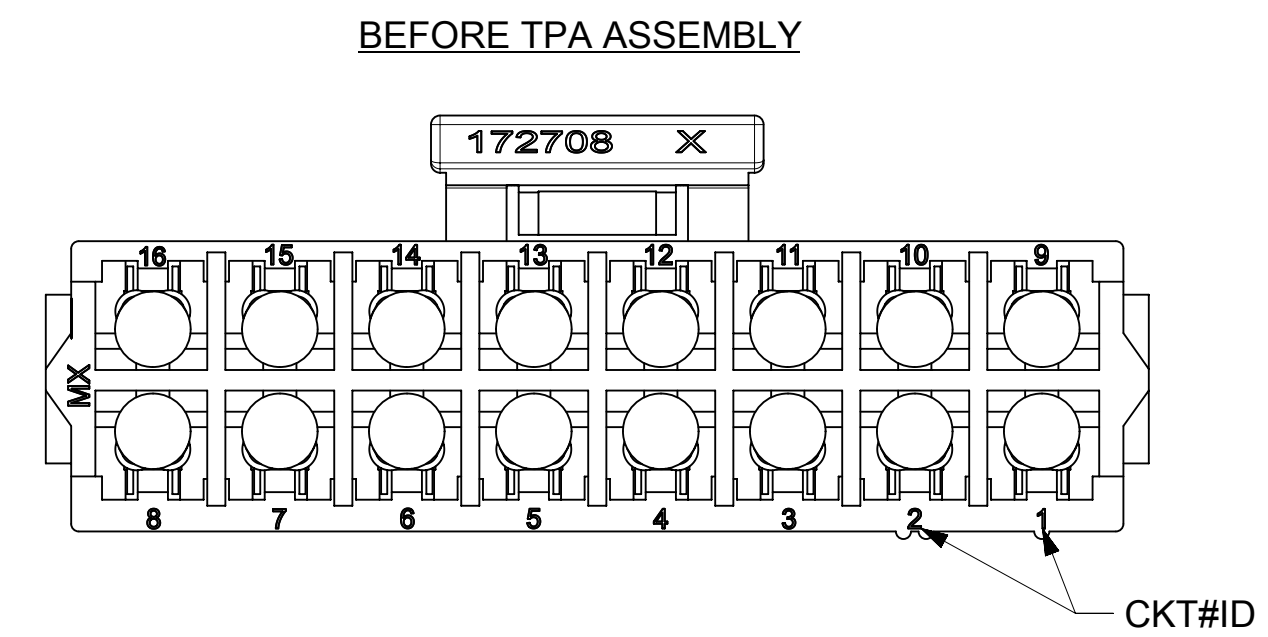

- NOTES:**
- MATERIAL:
'A' = NYLON V-0 LOW HALOGEN; COLOR: BLACK
'B' = NYLON V-2 GLOW WIRE CAPABLE; COLOR: BLACK
 - FINISH: NONE
 - PRODUCT SPECIFICATION: PS-172718-0000 and 2029880001-PS
APPLICATION SPECIFICATION: AS-172718-0000
 - PACKAGING SPECIFICATION: BULK
1727080001-PK
REFER TO AS-45499-001 FOR MOISTURIZING NYLON CONNECTOR PARTS.
 - THIS PART TO BE USED WITH FEMALE TERMINAL SERIES 172718, 202988 AND TPA SERIES 172709.
 - THIS PART MATES WITH SERIES 5559, 5566, 5569 AND 172767.
 - THIS PART CONFORMS TO CLASS 'B' REQUIREMENTS OF COSMETIC SPECIFICATION PS-45499-002.
 - THIS PRODUCT MUST BE USED WITH THE TPA INSTALLED.
 - SEE DRAWING 1727090001-SD FOR OTHER TPA INFORMATION.
 - SEE DRAWINGS SD-172718-0000 and 2029880001-PSD FOR OTHER CRIMP TERMINAL INFORMATION.



THIS DRAWING CONTAINS INFORMATION THAT IS PROPRIETARY TO MOLEX ELECTRONIC TECHNOLOGIES, LLC AND SHOULD NOT BE USED WITHOUT WRITTEN PERMISSION																	
DIMENSION UNITS	SCALE	CURRENT REV DESC: NEW TPA UPDT S1 & S2															
mm	5:1	<p>HOUSING, DUAL ROW RECEPTACLE MINI-FIT TPA2</p> <p>PRODUCT CUSTOMER DRAWING</p> <table border="1"> <tr> <td>DOCUMENT NUMBER</td> <td>DOC TYPE</td> <td>DOC PART</td> <td>REVISION</td> </tr> <tr> <td>SD-172708-0000</td> <td>PSD</td> <td>000</td> <td>H4</td> </tr> </table>								DOCUMENT NUMBER	DOC TYPE	DOC PART	REVISION	SD-172708-0000	PSD	000	H4
DOCUMENT NUMBER	DOC TYPE									DOC PART	REVISION						
SD-172708-0000	PSD									000	H4						
GENERAL TOLERANCES (UNLESS SPECIFIED)																	
ANGULAR TOL	± °																
4 PLACES	±																
3 PLACES	±																
2 PLACES	± 0.13																
1 PLACE	± 0.2																
0 PLACES	±																
DRAFT WHERE APPLICABLE MUST REMAIN WITHIN DIMENSIONS		THIRD ANGLE PROJECTION	DRAWING	SERIES	MATERIAL NUMBER	CUSTOMER	SHEET NUMBER										
			C-SIZE	172708	SEE TABLE	GENERAL MARKET	3 OF 4										

PART NUMBER	CKTS	DIM C	DIM D	MATERIAL
1727080014	14	30.60	34.40	A
1727080114				B
1727080016	16	34.80	38.60	A
1727080116				B
1727080018	18	39.00	42.80	A
1727080118				B
1727080020	20	43.20	47.00	A
1727080120				B
1727080022	22	47.40	51.20	A
1727080122				B
1727080024	24	51.60	55.40	A
1727080124				B

POLARIZATION DETAIL

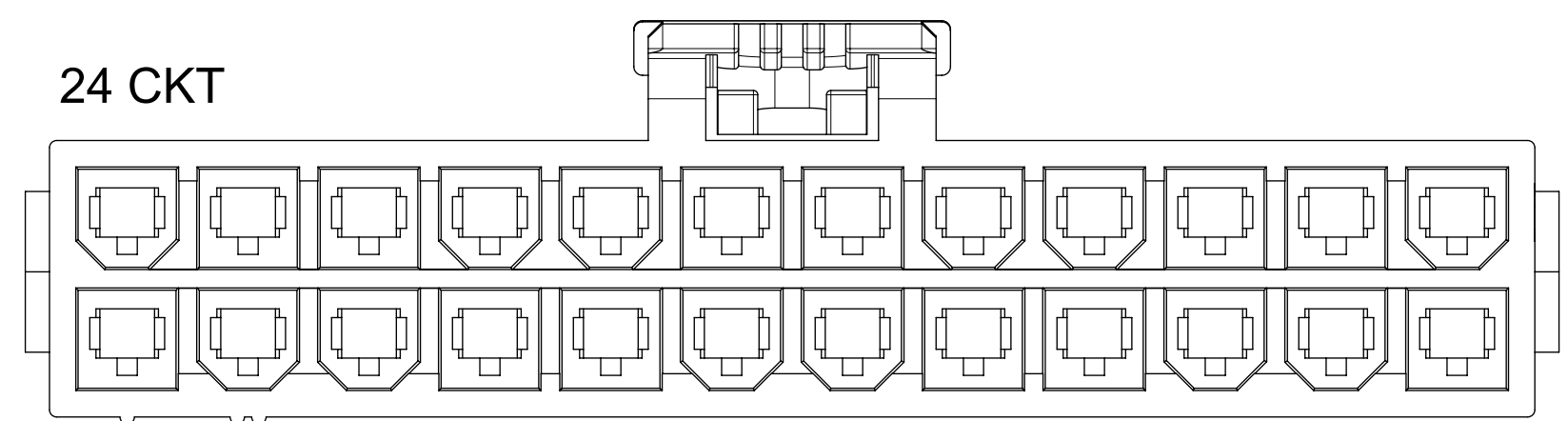
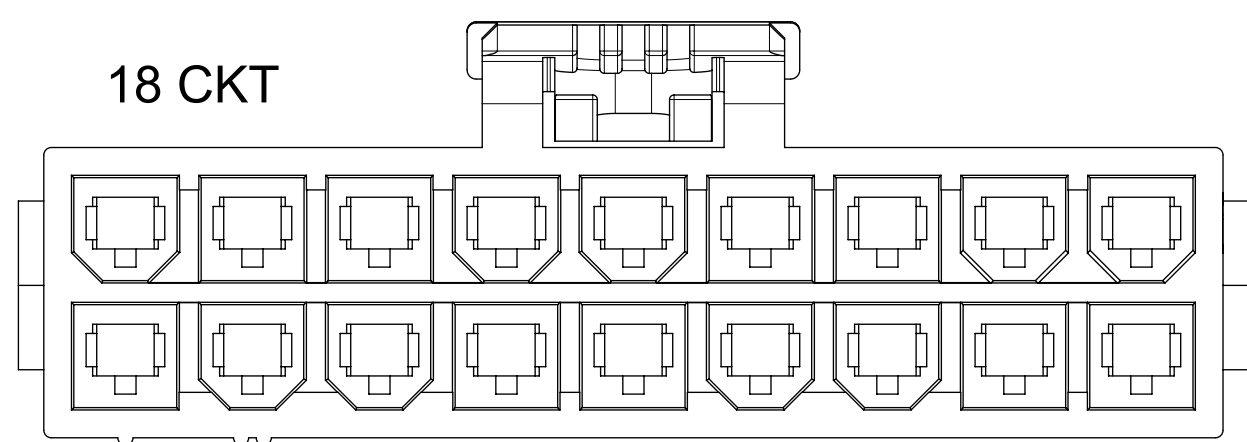
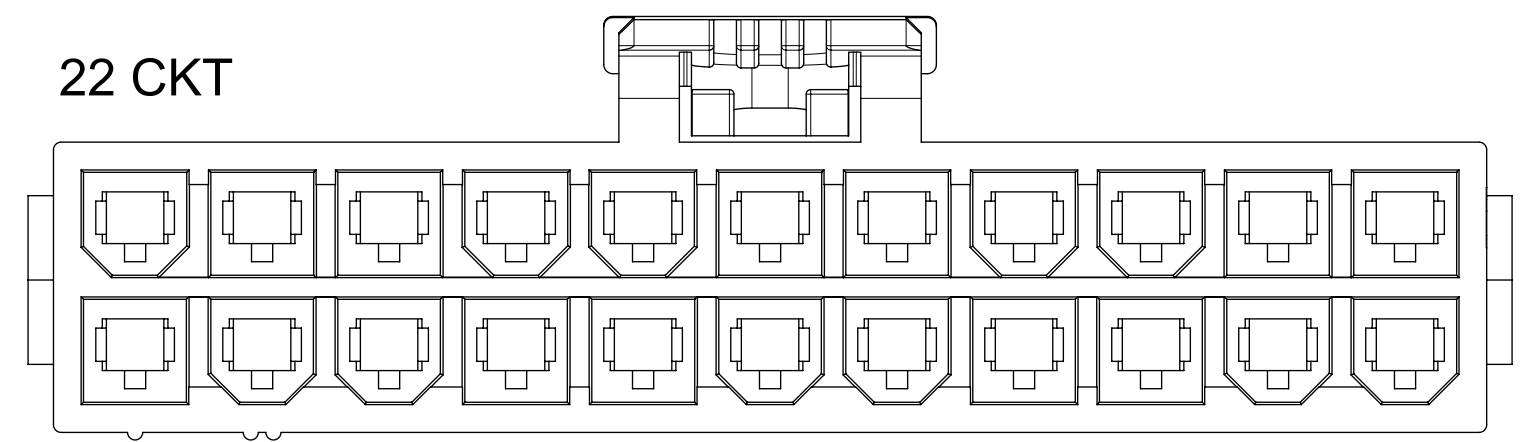
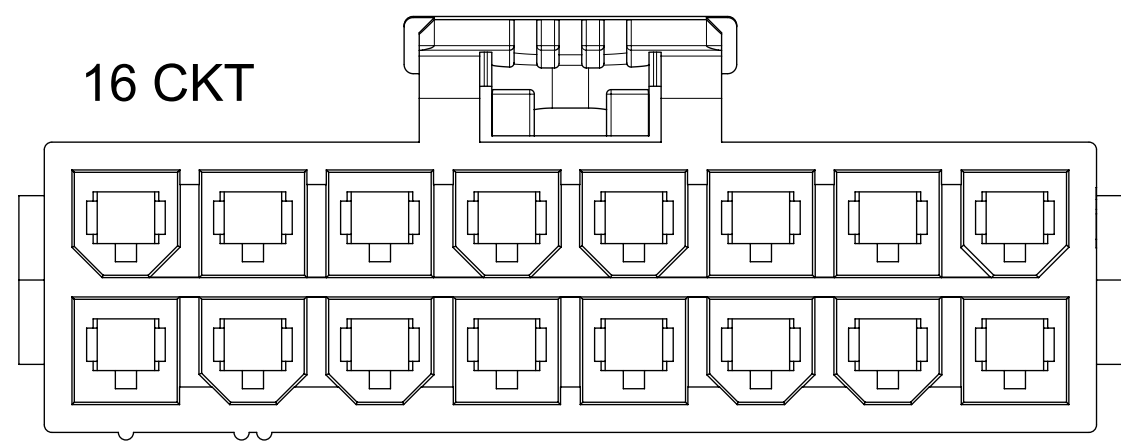
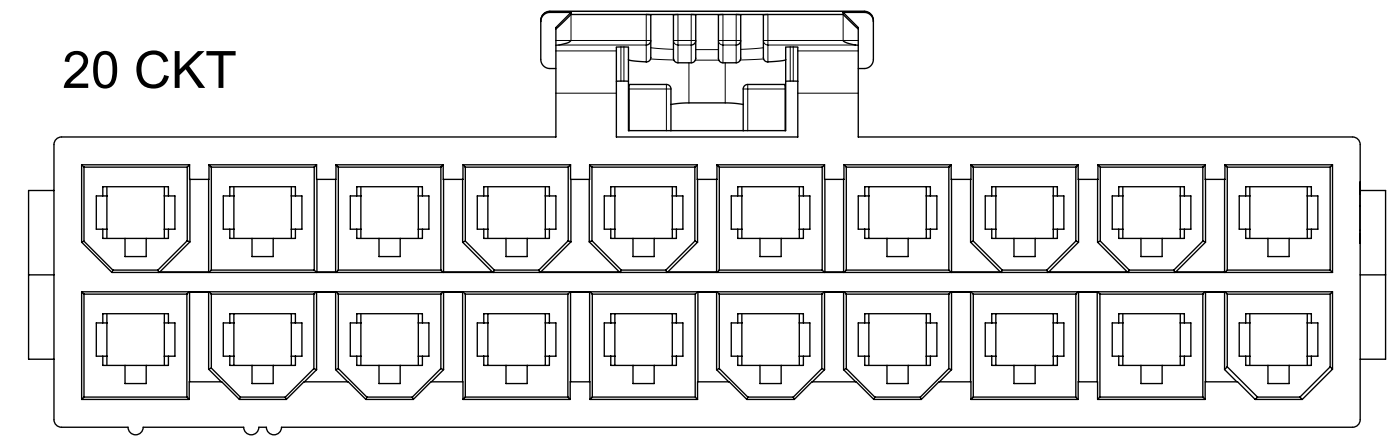
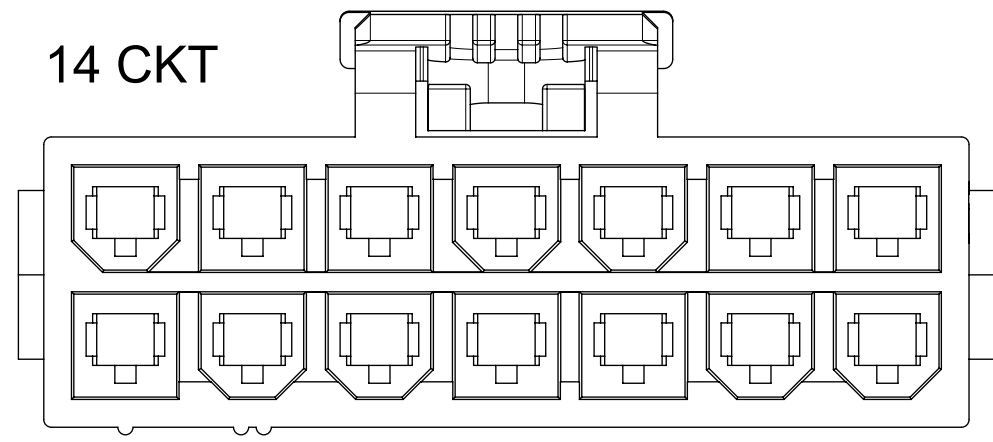
SHOWN WITHOUT TPA OR TERMINAL FOR CLARITY



THIS DRAWING CONTAINS INFORMATION THAT IS PROPRIETARY TO MOLEX ELECTRONIC TECHNOLOGIES, LLC AND SHOULD NOT BE USED WITHOUT WRITTEN PERMISSION													
DIMENSION UNITS		SCALE		CURRENT REV DESC: NEW TPA UPDT S1 & S2									
mm		5:1		 HOUSING, DUAL ROW RECEPTACLE MINI-FIT TPA2 PRODUCT CUSTOMER DRAWING									
GENERAL TOLERANCES (UNLESS SPECIFIED)										EC NO: 178886		2018/06/25	
ANGULAR TOL		± °								DRWN: VNANDAM		2018/07/20	
4 PLACES		±								CHK'D: SGANGADHARDO		2018/07/20	
3 PLACES		±								APPR: ISHWARG		2018/07/23	
2 PLACES		± 0.13		INITIAL REVISION:									
1 PLACE		± 0.2		DRWN: TGREGORI		2014/09/10		DOCUMENT NUMBER					
0 PLACES		±		APPR: RHODGE		2014/12/04		SD-172708-0000					
DRAFT WHERE APPLICABLE MUST REMAIN WITHIN DIMENSIONS				THIRD ANGLE PROJECTION		DRAWING		SERIES					
						C-SIZE		172708					
MATERIAL NUMBER				CUSTOMER		SHEET NUMBER		DOC TYPE DOC PART REVISION					
SEE TABLE				GENERAL MARKET		4 OF 4		PSD 000 H4					