

Prop Clip (#32200) Prop Plug (#32201)

USB to Serial Adapter for Propeller Circuits

Introduction

The Prop Plug and Prop Clip each provide a USB-to-serial port connection that is convenient for microcontroller programming and communication. These tiny devices are capable of asynchronous communication at up to 3 M baud with both 3.3-volt and 5.0-volt devices such as the Propeller and BASIC Stamp. The Prop Plug slips onto a 4-pin, 0.1" spaced male header, providing in-system programming of Propeller circuits in bread board, perf board and permanent projects which have the four-pin header. The Prop Clip is the same product, but designed for attaching to pads on the edge of a PCB. The Prop Clip could eliminate one part (a 4-pin header) from a PCB design for attaching the Prop Clip to the board.

The electrical schematic for both parts is the same, based on the FTDI232R.

The Propeller Demo Board (#32100) and the Propeller Professional Development Board (#32111) do not require the Prop Clip or Prop Plug; both of these boards have the USB-to-serial circuit built into the PCB. The Propeller Proto Board (planned release Q1 2007) accepts the Prop Plug out of the box, and the layout also supports the USB2SER and the Prop Clip.

Both products include the USB A to Mini B Retractable Cable (#805-00010).

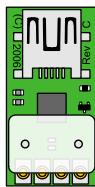

Prop Clip

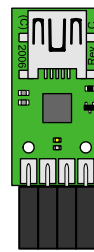

Prop Plug

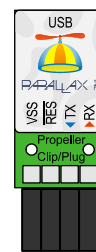

PC Drivers Installation

For Windows 2000/XP driver installation visit www.parallax.com and follow the USB Driver installation steps as shown below; there is a link to troubleshooting instructions if needed. If you install the Propeller IDE, these drivers install automatically.

Installing USB Drivers

step **1** Download
'Parallax USB Driver Installer'

Click
Here to
Download

step **2** Run the Installer
*Follow the steps provided by the Wizard
to install your hardware drivers.*



step **3** Connect Your Hardware

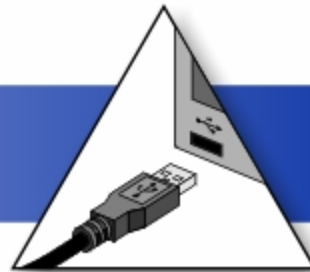

Interface to Propeller Chip

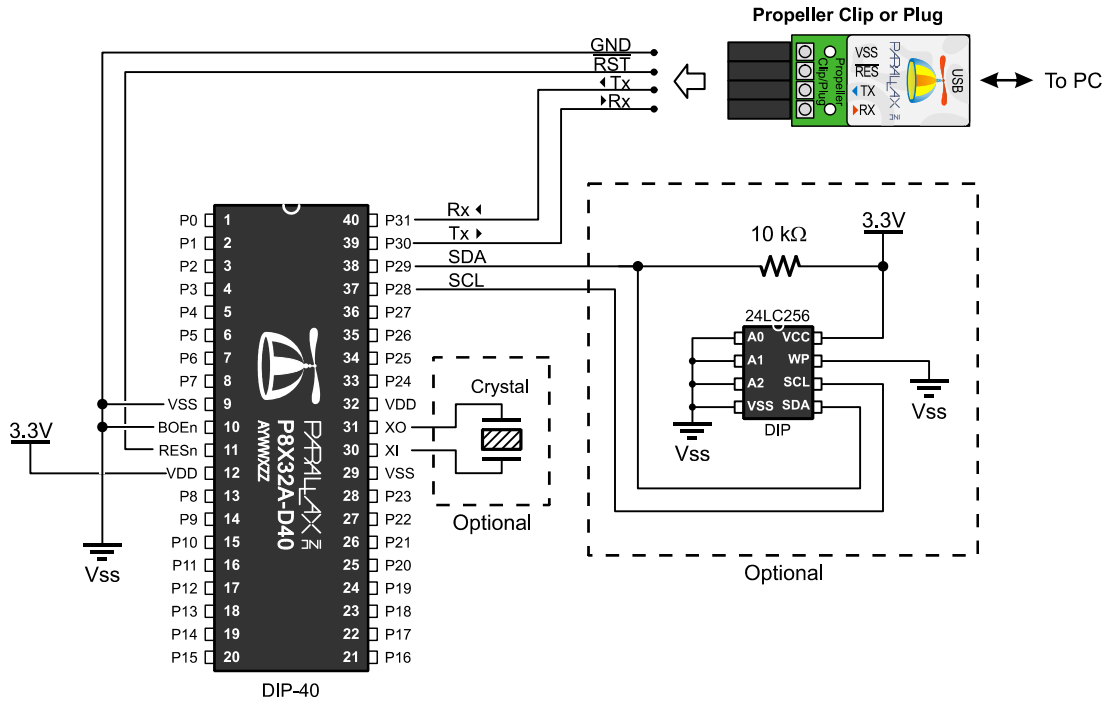

Dimensions

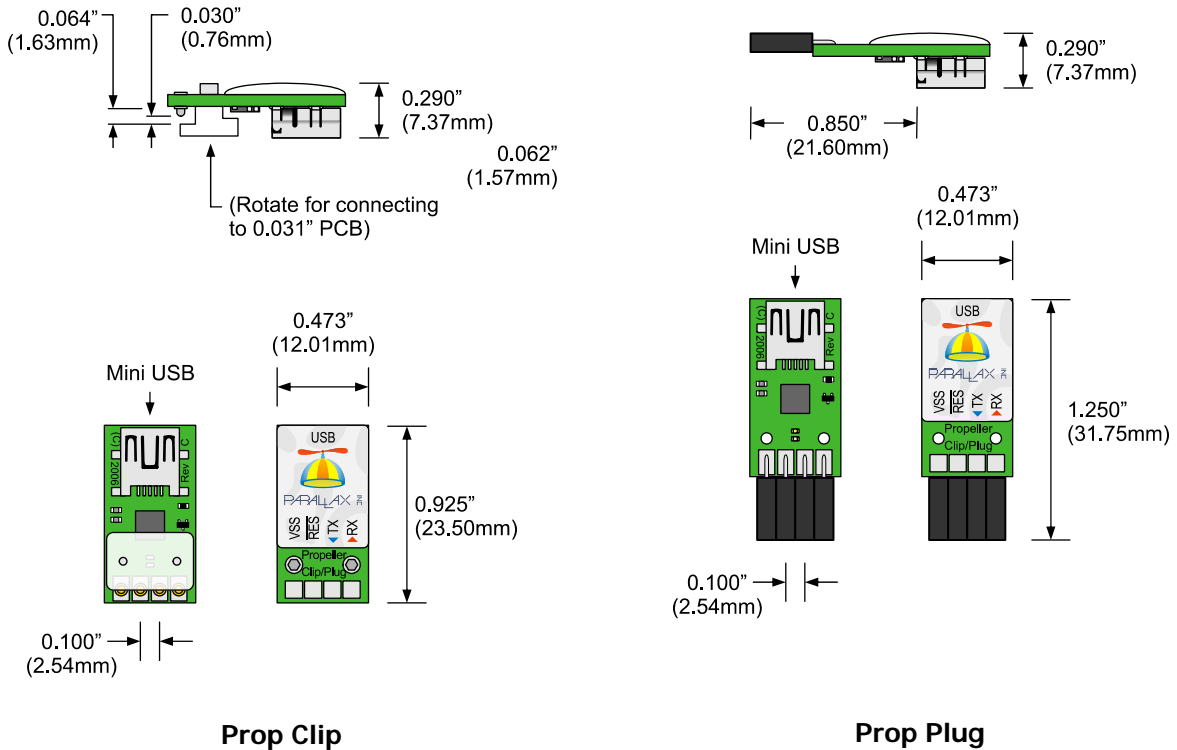

Design Requirements for Using the Prop Clip on a Custom PCB

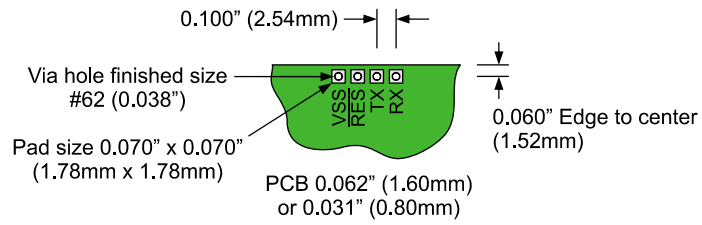

Printed circuit board design requirements.

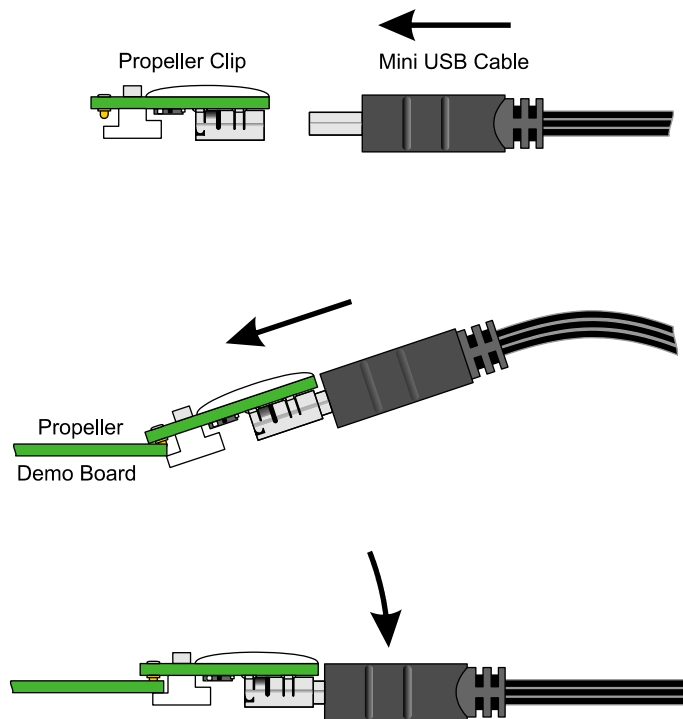

Plugging the Prop Clip on to a custom PCB.

Schematic – Revision A

Parallax is also an authorized distributor of FTDI chips. You can build your own Prop Clip / Prop Plug adapter from our schematic.

