

ISL8117AEVAL1Z Evaluation Board User Guide

Description

The ISL8117AEVAL1Z evaluation board (shown in [Figure 4 on page 4](#)) features the [ISL8117A](#). The ISL8117A is a 60V high voltage synchronous buck controller that offers external soft-start, independent enable functions and integrates UV/OV/OC/OT protection. Its current mode control architecture and internal compensation network keep peripheral component count minimal. Programmable switching frequency ranging from 100kHz to 2MHz helps to optimize inductor size while the strong gate driver delivers up to 30A for the buck output.

Specifications

The ISL8117AEVAL1Z evaluation board is designed for high current applications. The current rating of the ISL8117AEVAL1Z is limited by the FETs and inductor selected. The ISL8117A gate driver is capable of delivering up to 20A for the buck output as long as the proper FETs and inductor are provided. The electrical ratings of the ISL8117AEVAL1Z are shown in [Table 1](#).

TABLE 1. ELECTRICAL RATING

PARAMETER	RATING
Input Voltage	18V to 60V
Switching Frequency	300kHz
Output Voltage	12V
Output Current	20A
OCP Set Point	Minimum 25A at ambient room temperature

Key Features

- Wide input range: 18V to 60V
- High light-load efficiency in pulse skipping DEM operation
- Programmable soft-start
- Optional DEM/CCM operation
- Supports prebias output with SR soft-start
- External frequency sync
- PGOOD indicator
- OCP, OVP, OTP, UVP protection
- Back biased from output to improve efficiency

References

[ISL8117A Datasheet](#)

Ordering Information

PART NUMBER	DESCRIPTION
ISL8117AEVAL1Z	High voltage PWM step-down synchronous buck controller evaluation board

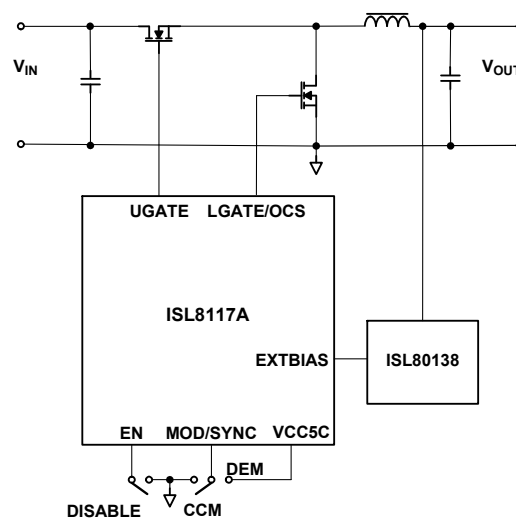

FIGURE 1. BLOCK DIAGRAM

Recommended Testing Equipment

The following materials are recommended to perform testing:

- 0V to 60V power supply with at least 30A source current capability
- Electronic loads capable of sinking current up to 30A
- Digital Multimeters (DMMs)
- 100MHz quad-trace oscilloscope

Quick Test Guide

1. Jumper J5 provides the option to select CCM or DEM. Please refer to [Table 2](#) for the desired operating option. Ensure that the circuit is correctly connected to the supply and electronic loads prior to applying any power. Please refer to [Figure 3](#) for proper set-up.
2. Turn on the power supply.
3. Adjust input voltage V_{IN} within the specified range and observe output voltage. The output voltage variation should be within 3%.
4. Adjust load current within the specified range and observe output voltage. The output voltage variation should be within 3%.
5. Use an oscilloscope to observe output voltage ripple and Phase node ringing. For accurate measurement, please refer to [Figure 2](#) for proper test set-up.

TABLE 2. DESIRED OPERATING OPTIONS

JUMPER #	POSITION	FUNCTION
J5	CCM (Pin 1-2)	Continuous current mode
	DEM (Pin 2-3)	Diode emulation mode
J6	(Pin 1-2)	Disable the PWM

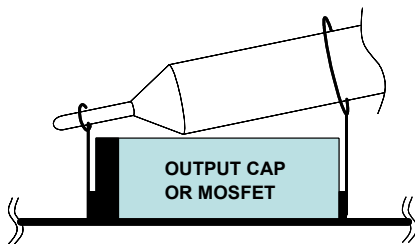

FIGURE 2. PROPER PROBE SET-UP TO MEASURE OUTPUT RIPPLE AND PHASE NODE RINGING

Functional Description

The ISL8117AEVAL1Z is the same test board used by the Intersil application engineers and IC designers to evaluate the performance of the ISL8117A QFN IC. The board is set to provide an easy and complete evaluation of all the IC and board functions.

As shown in [Figure 3 on page 3](#), 18V to 60V V_{IN} is supplied to J1 (+) and J2 (-). The regulated 12V output on J3 (+) and J4 (-) can supply up to 20A to the load. Due to the high thermal efficiency, the evaluation board can run at 20A continuously without airflow under room temperature ambient conditions.

Test points TP1 through TP19 provide easy access to IC pin and external signal injection terminals.

As shown in [Table 2](#), connector J5 provides selection of either CCM mode (shorting pin 1 and pin 2) or DEM mode (shorting pin 2 and pin 3). Connector J6 provides an option to disable the converter by shorting its pin 1 and 2.

Operating Range

The input voltage range is from 18V to 60V for an output voltage of 12V. If the output voltage is set to a lower value, the minimum V_{IN} can be reset to a lower value by changing the ratio of R_4 and R_5 . The minimum EN threshold that V_{IN} can be set to is 4.5V.

The rated load current is 20A with the OCP point set at minimum 25A at room ambient condition.

The operating temperature range is from -40°C to $+125^{\circ}\text{C}$. Please note that airflow is needed for higher temperature ambient conditions.

PCB Layout Guideline

Careful attention to layout requirements is necessary for successful implementation of an ISL8117A based DC/DC converter. The ISL8117A switches at a very high frequency and therefore the switching times are very short. At these switching frequencies, even the shortest trace has significant impedance. Also, the peak gate drive current rises significantly in an extremely short time. Transition speed of the current from one device to another causes voltage spikes across the interconnecting impedances and parasitic circuit elements. These voltage spikes can degrade efficiency, generate EMI, and increase device overvoltage stress and ringing. Careful component selection and proper PC board layout minimizes the magnitude of these voltage spikes.

There are three sets of critical components in a DC/DC converter using the ISL8117A:

- The controller
- The switching power components
- The small signal components

The switching power components are the most critical from a layout point of view because they switch a large amount of energy, which tends to generate a large amount of noise. The critical small signal components are those connected to sensitive nodes or those supplying critical bias currents. A multilayer printed circuit board is recommended.

Layout Considerations

1. The input capacitors, upper FET, lower FET, inductor and output capacitor should be placed first. Isolate these power components on the top side of the board with their ground terminals adjacent to one another. Place the input high frequency decoupling ceramic capacitors very close to the MOSFETs.
2. Use separate ground planes for power ground and small signal ground. Connect the SGND and PGND together close to the IC. DO NOT connect them together anywhere else.
3. The loop formed by the input capacitor, the top FET and the bottom FET must be kept as small as possible.
4. Ensure the current paths from the input capacitor to the MOSFET, to the output inductor and the output capacitor are as short as possible with maximum allowable trace widths.
5. Place the PWM controller IC close to the lower FET. The LGATE connection should be short and wide. The IC can be best placed over a quiet ground area. Avoid switching ground loop currents in this area.
6. Place VCC5V bypass capacitor very close to the VCC5V pin of the IC and connect its ground to the PGND plane.
7. Place the gate drive components (optional BOOT diode and BOOT capacitors) together near the controller IC.
8. The output capacitors should be placed as close to the load as possible. Use short wide copper regions to connect output capacitors to load in order to avoid inductance and resistances.
9. Use copper filled polygons or wide but short trace to connect the junction of the upper FET, lower FET and output inductor. Also keep the PHASE node connection to the IC short. DO NOT unnecessarily oversize the copper islands for the PHASE node. Since the phase nodes are subjected to very high dv/dt voltages, the stray capacitor formed between these islands and the surrounding circuitry will tend to couple switching noise.
10. Route all high speed switching nodes away from the control circuitry.
11. Create a separate small analog ground plane near the IC. Connect the SGND pin to this plane. All small signal grounding paths including feedback resistors, current limit setting resistor, soft-starting capacitor and EN pull-down resistors should be connected to this SGND plane.
12. Separate the current sensing trace from the PHASE node connection.
13. Ensure the feedback connection to the output capacitor is short and direct.

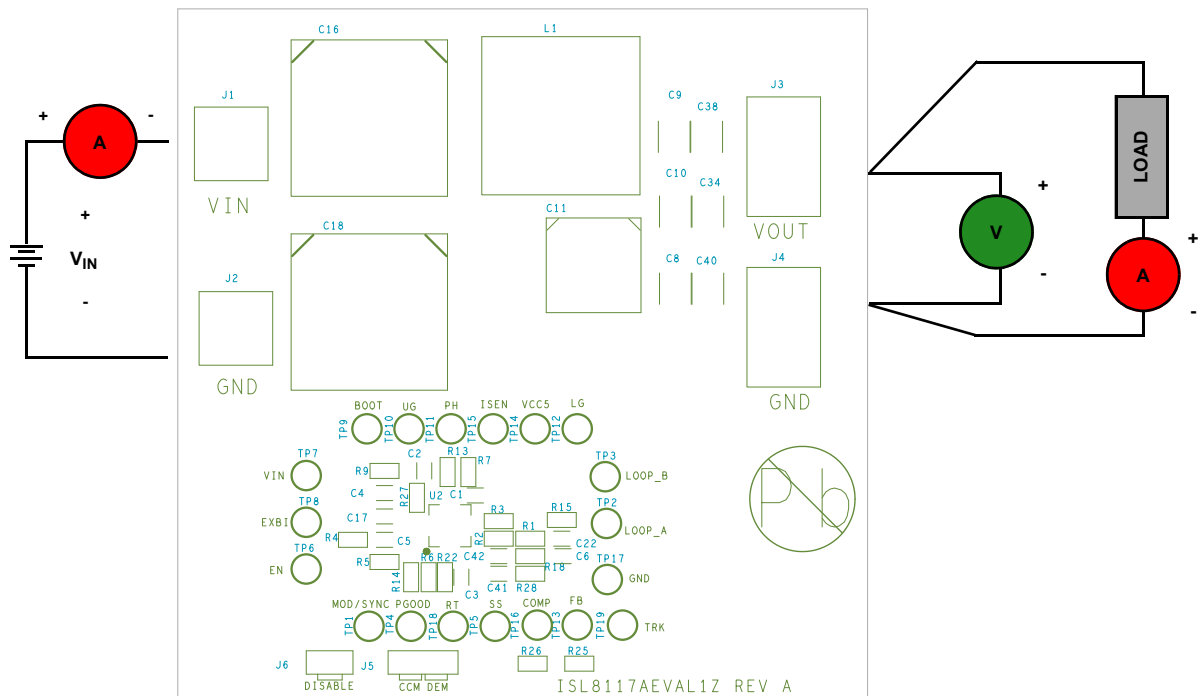

FIGURE 3. PROPER TEST SET-UP

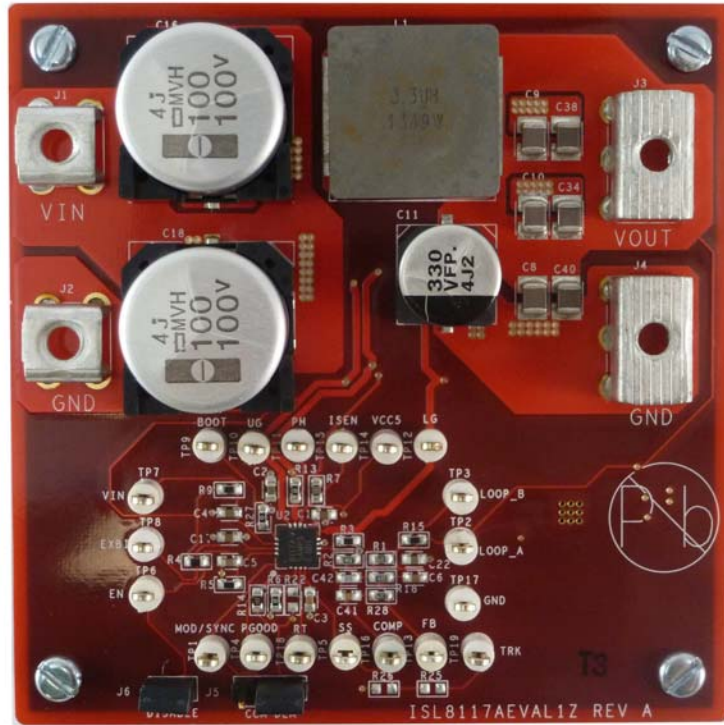

FIGURE 4. ISL8117AEVAL1Z TOP SIDE

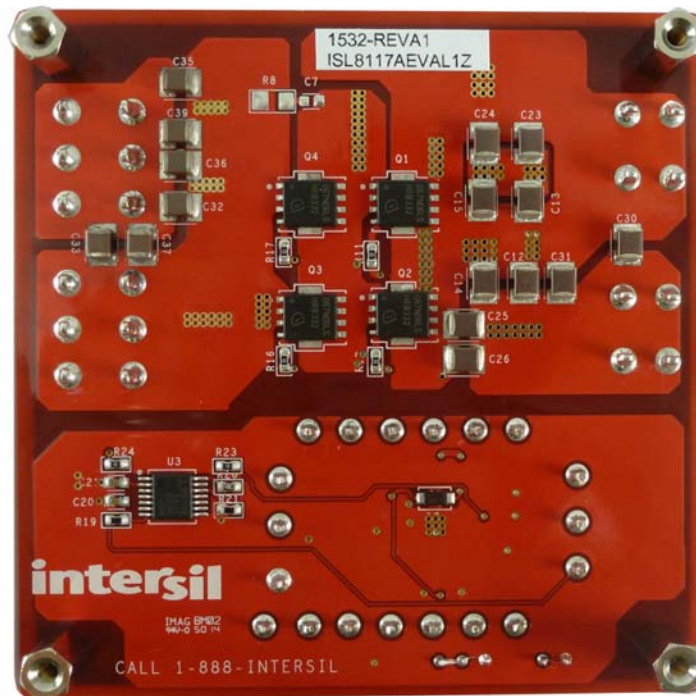

FIGURE 5. ISL8117AEVAL1Z BOTTOM SIDE

Typical Evaluation Board Performance Curves $V_{IN} = 48V$, unless otherwise noted.

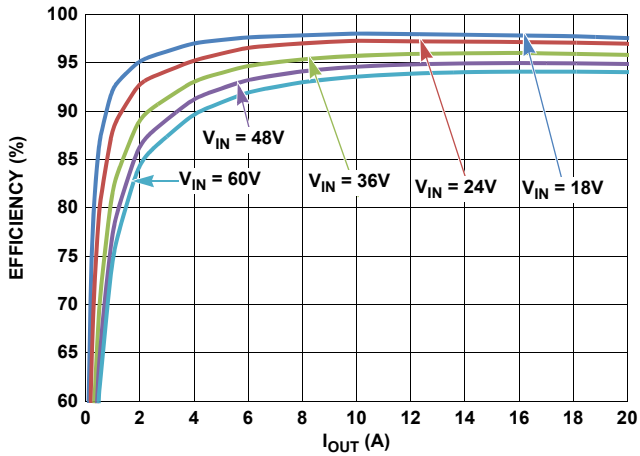

FIGURE 6. CCM EFFICIENCY vs LOAD

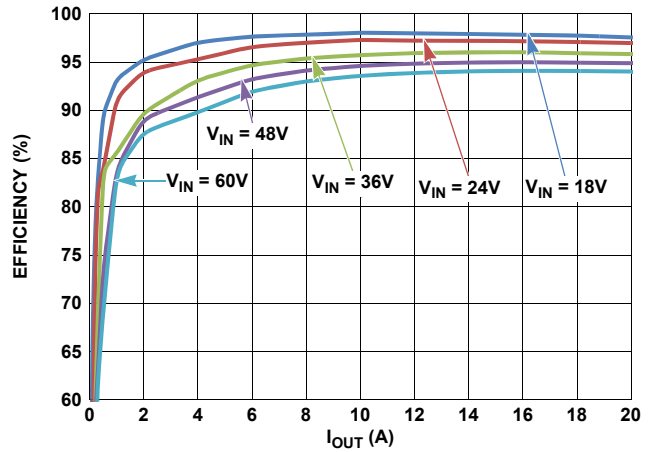

FIGURE 7. DEM EFFICIENCY vs LOAD

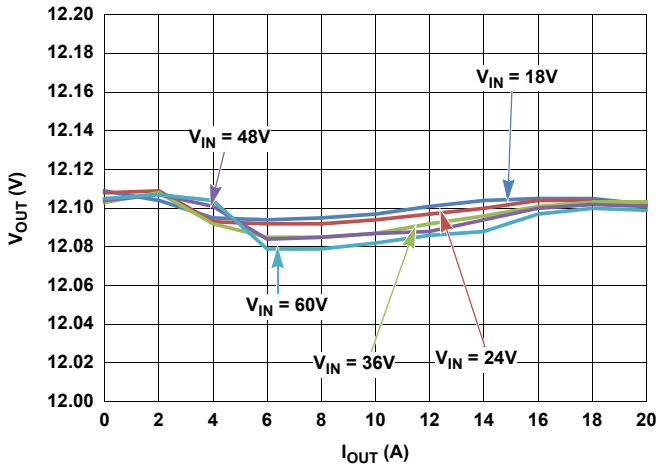

FIGURE 8. CCM MODE LOAD REGULATION

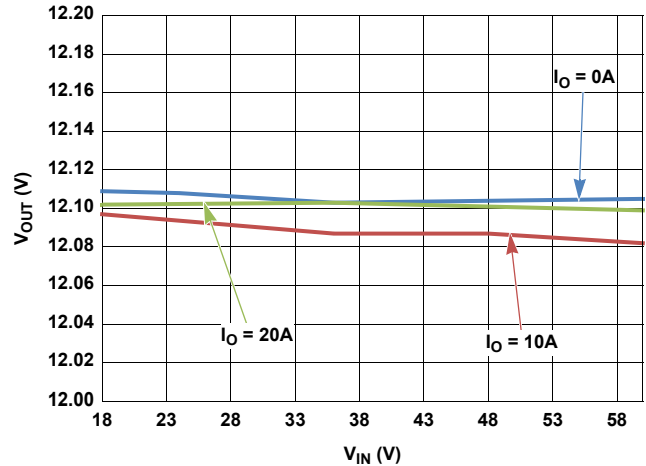

FIGURE 9. CCM MODE LINE REGULATION

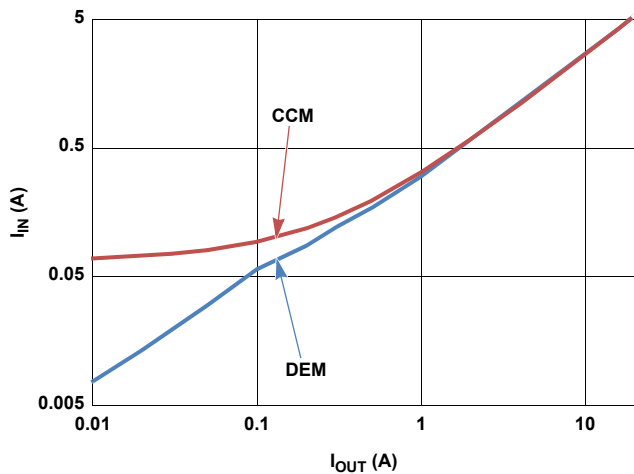

FIGURE 10. INPUT CURRENT COMPARISON WITH MODE = CCM/DEM

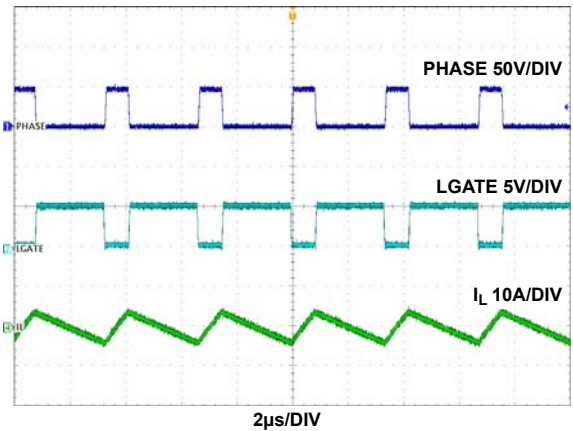

FIGURE 11. PHASE, LGATE AND INDUCTOR CURRENT WAVEFORMS

Typical Evaluation Board Performance Curves $V_{IN} = 48V$, unless otherwise noted. (Continued)

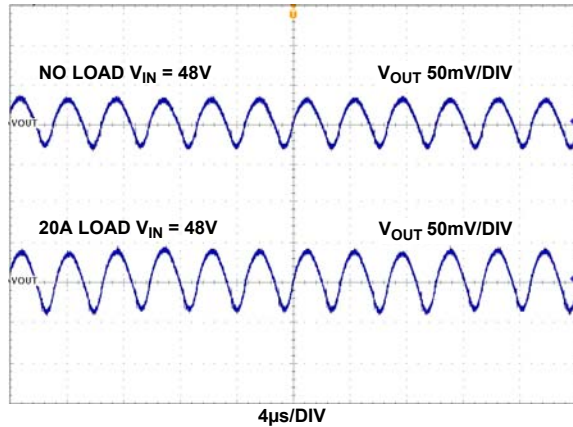

FIGURE 12. OUTPUT RIPPLE, MODE = CCM

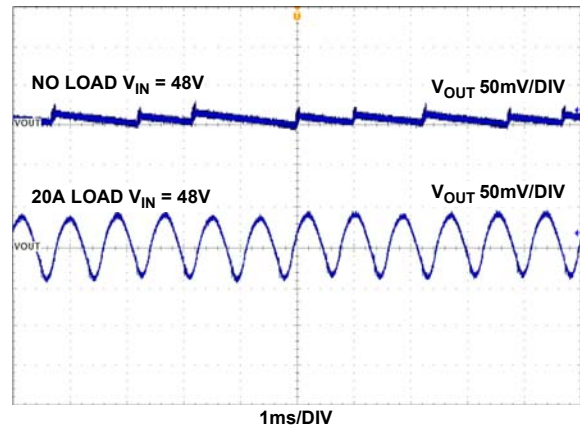

FIGURE 13. OUTPUT RIPPLE, MODE = DEM

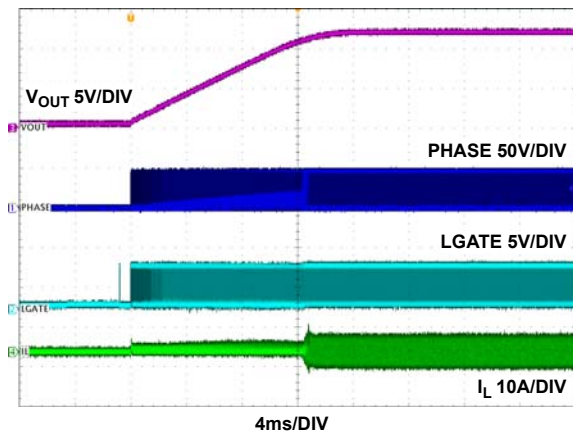

FIGURE 14. START-UP WAVEFORMS; MODE = CCM, LOAD = 0A, $V_{IN} = 48V$

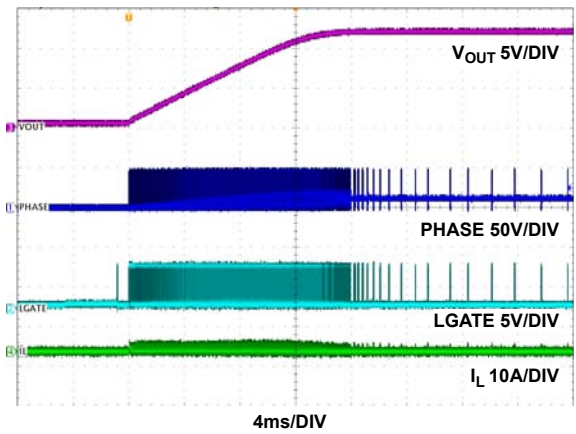

FIGURE 15. START-UP WAVEFORMS; MODE = DEM, LOAD = 0A, $V_{IN} = 48V$

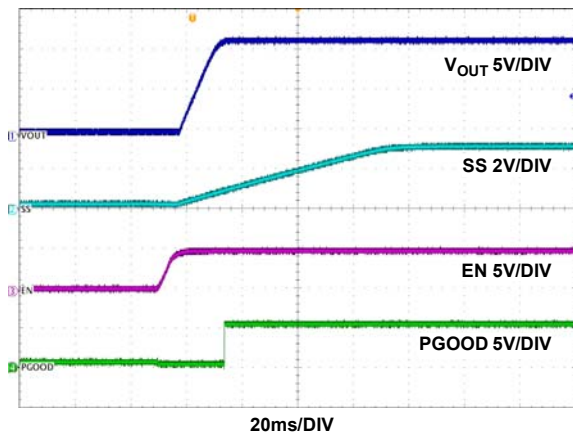

FIGURE 16. START-UP WAVEFORMS; MODE = CCM, LOAD = 0A, $V_{IN} = 48V$

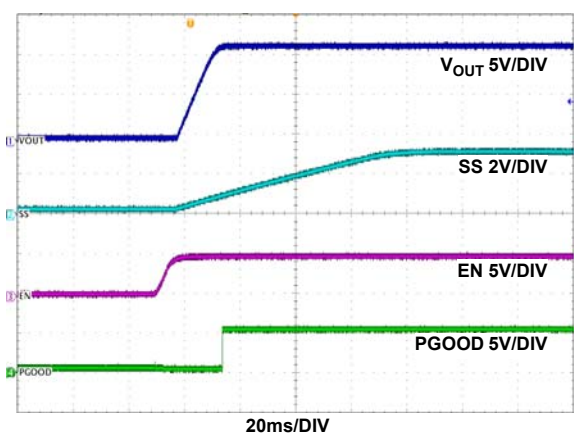

FIGURE 17. START-UP WAVEFORMS; MODE = DEM, LOAD = 0A, $V_{IN} = 48V$

Typical Evaluation Board Performance Curves $V_{IN} = 48V$, unless otherwise noted. (Continued)

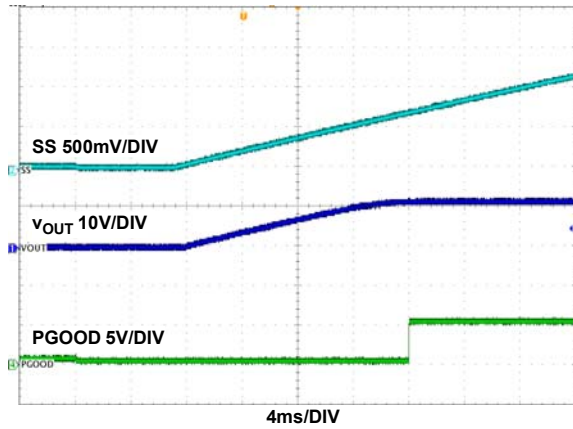

FIGURE 18. TRACKING; $V_{IN} = 48V$, LOAD = 0A, MODE = CCM

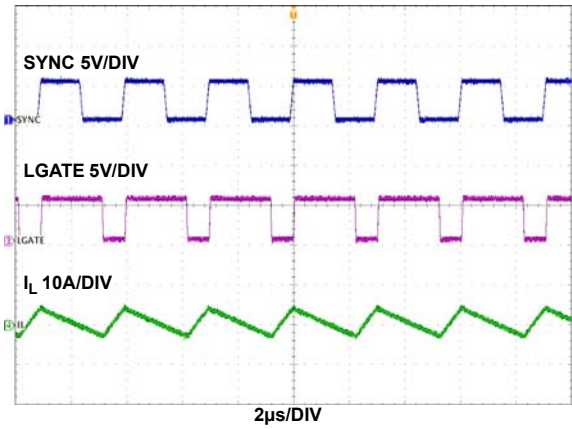

FIGURE 19. FREQUENCY SYNCHRONIZATION; $V_{IN} = 48V$, LOAD = 0A, DEFAULT $f_{SW} = 300kHz$, SYNC $f_{SW} = 330kHz$

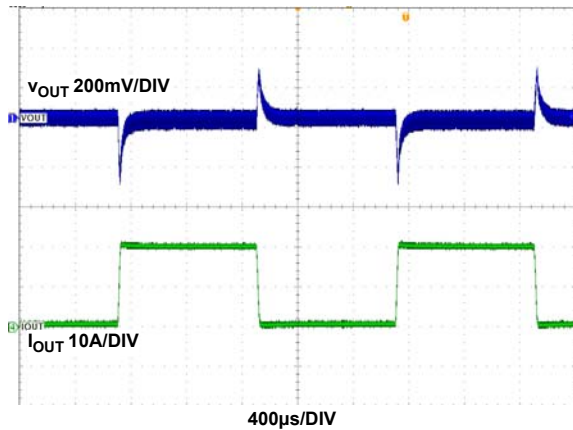

FIGURE 20. LOAD TRANSIENT RESPONSE; $V_{IN} = 48V$, 0A TO 20A $1A/\mu s$ STEP LOAD, CCM MODE

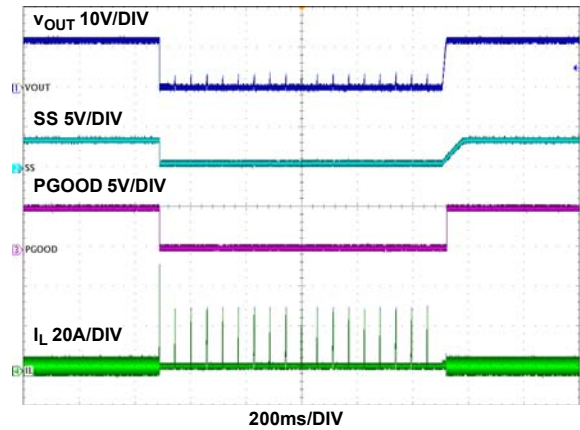

FIGURE 21. OCP RESPONSE, OUTPUT SHORT CIRCUITED TO GROUND AND RELEASED, CCM MODE, $V_{IN} = 48V$ NO LOAD TO SHORT AND RELEASE

Schematic

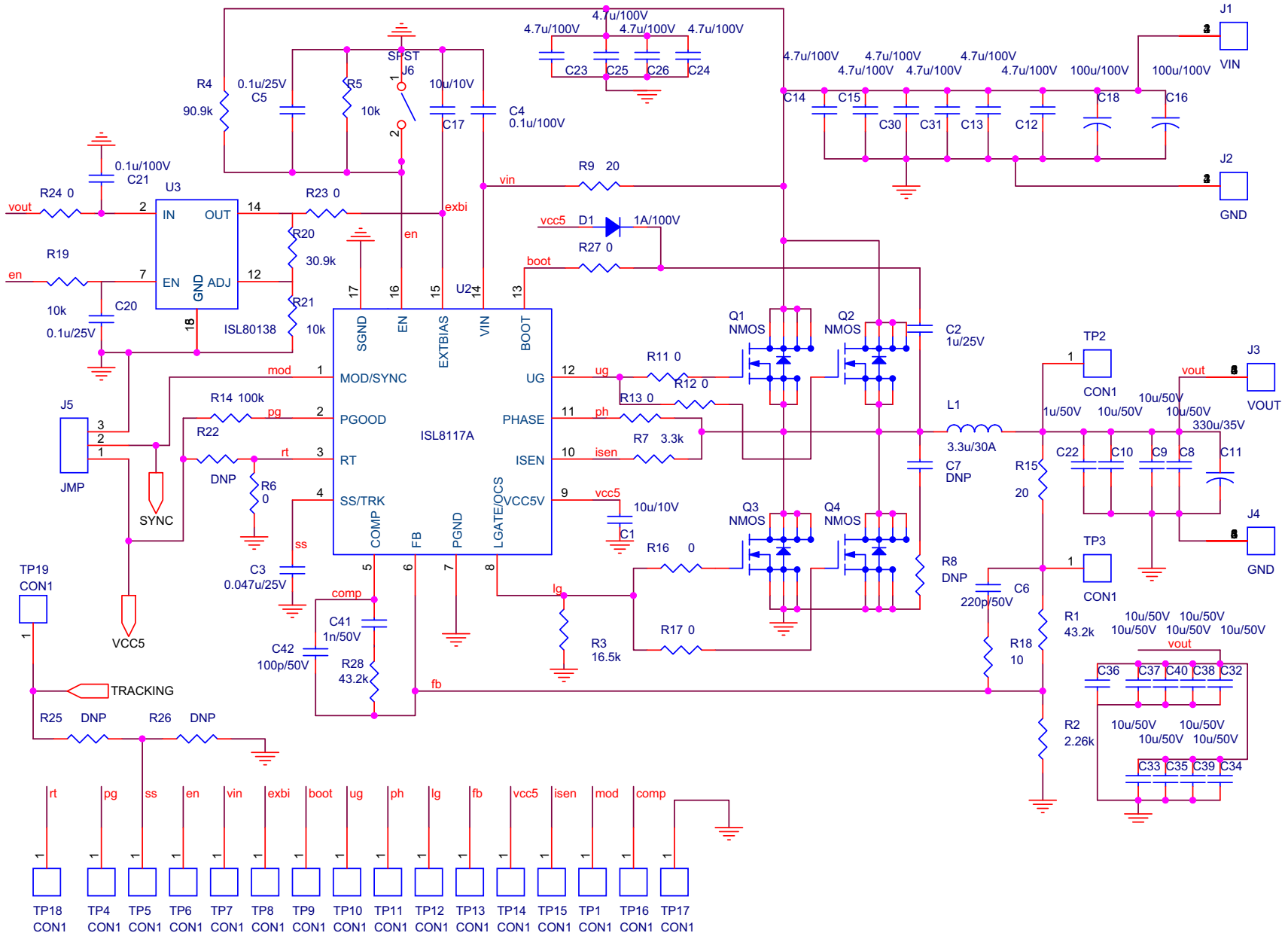

FIGURE 22. ISL8117AEVAL1Z SCHEMATIC

User Guide 049

Bill of Materials

MANUFACTURER PART	QTY	UNITS	REFERENCE DESIGNATOR	DESCRIPTION	MANUFACTURER
ISL8117AEVAL1ZREVAPCB	1	ea.		PWB-PCB, ISL8117EVAL1Z, REVA, ROHS	SHENZHEN MULTILAYER PCB TECHNOLOGY CO.,LTD
ECJ-1VC1H101J	1	ea.	C42	CAP, SMD, 0603, 100pF, 50V, 5%, COG, ROHS	PANASONIC
06035C102KAT2A	1	ea.	C41	CAP, SMD, 0603, 1000pF, 50V, 10%, X7R, ROHS	AVX
C0603X7R101-104KNE	2	ea.	C4, C21	CAP, SMD, 0603, 0.1µF, 100V, 10%, X7R, ROHS	VENKEL
GRM39X7R104K025AD	2	ea.	C5, C20	CAP, SMD, 0603, 0.1µF, 25V, 10%, X7R, ROHS	MURATA
C1608X5R1H105K	2	ea.	C2, C22	CAP, SMD, 0603, 1µF, 50V, 10%, X5R, ROHS	TDK
ECJ-1VB1A106M	2	ea.	C1, C17	CAP, SMD, 0603, 10µF, 10V, 20%, X5R, ROHS	PANASONIC
GRM188R71H221KA01D	1	ea.	C6	CAP, SMD, 0603, 220pF, 50V, 10%, X7R, ROHS	MURATA
GRM188R71E473KA01D	1	ea.	C3	CAP, SMD, 0603, 0.047µF, 25V, 10%, X7R, ROHS	MURATA
	0	ea.	C7	CAP, SMD, 0603, DNP-PLACE HOLDER, ROHS	
UMK325BJ106KM-T	12	ea.	a) C8, C9, C10, C32, C33, C34, C35, C36, C37	CAP, SMD, 1210, 10µF, 50V, 10%, X5R, ROHS	TAIYO YUDEN
UMK325BJ106KM-T	0	ea.	b) C38, C39, C40.	CAP, SMD, 1210, 10µF, 50V, 10%, X5R, ROHS	TAIYO YUDEN
CGA6M3X7S2A475K200AB	10	ea.	a) C12, C13, C14, C15, C23, C24, C25, C26	CAP, SMD, 1210, 4.7µF, 100V, 10%, X7S, ROHS	TDK
CGA6M3X7S2A475K200AB	0	ea.	b) C30, C31	CAP, SMD, 1210, 4.7µF, 100V, 10%, X7S, ROHS	TDK
EEE-FP1V331AP	1	ea.	C11	CAP, SMD, 10x10.2mm, 330µF, 35V, 20%, ALUM.ELEC., ROHS	PANASONIC
EMVH101GDA101MLH0S	2	ea.	C16, C18	CAP, SMD, 16x16.5mm, 100µF, 100V, 20%, ALUM.ELEC., ROHS	UNITED CHEMI-CON
IHLP6767GZER3R3M11	1	ea.	L1	COIL-PWR INDUCTOR, SMD, 17.15mmSQ., 3.3µH, 20%, 35A, ROHS	VISHAY
5007	19	ea.	TP1-TP19	CONN-COMPACT TEST PT, VERTICAL, WHT, ROHS	KEYSTONE
68000-236HLF	1	ea.	J5	CONN-HEADER, 1x3, BREAKAWY 1X36, 2.54mm, ROHS	BERG/FCI
69190-202HLF	1	ea.	J6	CONN-HEADER, 1X2, RETENTIVE, 2.54mm, 0.230X 0.120, ROHS	BERG/FCI
SPC02SYAN	2	ea.	J5, J6	CONN-JUMPER, SHORTING, 2PIN, BLACK, GOLD, ROHS	SULLINS
MBR1H100SFT3G	1	ea.	D1	DIODE-RECTIFIER, SMD, 2P, SOD-123FL, 100V, 1A, ROHS	ON SEMICONDUCTOR
ISL80138IVEAJZ	1	ea.	U3	IC-40V LDO ADJ. LINEAR REGULATOR, 14P, HTSSOP, ROHS	INTERSIL
ISL8117AFRZ	1	ea.	U2	IC-55V SWITCHING CONTROLLER, 16P, QFN, ROHS	INTERSIL
BSC067N06LS3G	4	ea.	Q1, Q2, Q3, Q4	TRANSISTOR-MOS, N-CHANNEL, 8P, PG-TDSON-8, 60V, 50A, ROHS	INFINEON TECHNOLOGY
RK73H1JT10R0F	1	ea.	R18	RES, SMD, 0603, 10Ω, 1/10W, 1%, TF, ROHS	KOA
ERJ-3EKF20R0V	2	ea.	R9, R15	RES, SMD, 0603, 20Ω, 1/10W, 1%, TF, ROHS	PANASONIC
CR0603-10W-000T	9	ea.	R6, R11, R12, R13, R16, R17, R23, R24, R27	RES, SMD, 0603, 0Ω, 1/10W, TF, ROHS	VENKEL
RK73H1JT1002F	3	ea.	R5, R19, R21	RES, SMD, 0603, 10k, 1/10W, 1%, TF, ROHS	KOA

Bill of Materials

MANUFACTURER PART	QTY	UNITS	REFERENCE DESIGNATOR	DESCRIPTION	MANUFACTURER
CR0603-10W-1003FT	1	ea.	R14	RES, SMD, 0603, 100k, 1/10W, 1%, TF, ROHS	VENKEL
	1	ea.	R3	RES, SMD, 0603, 8.2k, 1/10W, 1%, TF, ROHS	
RC0603FR-072K26L	1	ea.	R2	RES, SMD, 0603, 2.26k, 1/10W, 1%, TF, ROHS	YAGEO
RC0603FR-0730K9L	1	ea.	R20	RES, SMD, 0603, 30.9k, 1/10W, 1%, TF, ROHS	YAGEO
MCR03EZPFX3301	1	ea.	R7	RES, SMD, 0603, 3.3kΩ, 1/10W, 1%, TF, ROHS	ROHM
RC0603FR-0743K2L(PbFREE)	2	ea.	R1, R28	RES, SMD, 0603, 43.2k, 1/10W, 1%, TF, ROHS	YAGEO
ERJ-3EKF9092V	1	ea.	R4	RES, SMD, 0603, 90.9k, 1/10W, 1%, TF, ROHS	PANASONIC
	0	ea.	R22, R25, R26	RES, SMD, 0603, DNP-PLACE HOLDER, ROHS	
	0	ea.	R8	RES, SMD, 1206, DNP, DNP, DNP, TF, ROHS	
7795	2	ea.	J1, J2	HDWARE, TERMINAL, M4 METRIC SCREW, TH, 4P, SNAP-FIT, ROHS	KEYSTONE
7798	2	ea.	J3, J4	HDWARE, TERMINAL, M4 METRIC SCREW, TH, 6P, SNAP-FIT, ROHS	KEYSTONE
R25-1001002	4	ea.	Four corners	STANDOFF, M2.5, 10mm, METRIC, F/F, HEX, THREADED, ROHS	HARWIN INC
29301	4	ea.	Four corners	SCREW, M2.5, 6mm, METRIC, PANHEAD, SLOTTED, STEEL, ROHS	KEYSTONE

ISL8117AEVAL1Z PCB Layout

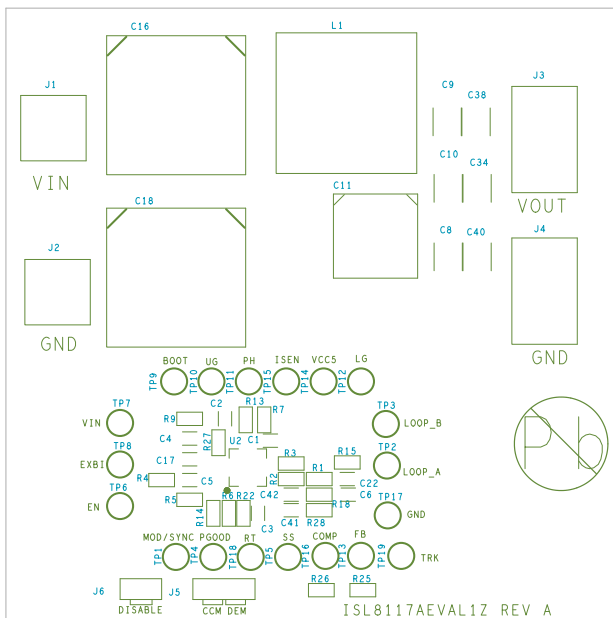

FIGURE 23. SILKSCREEN TOP

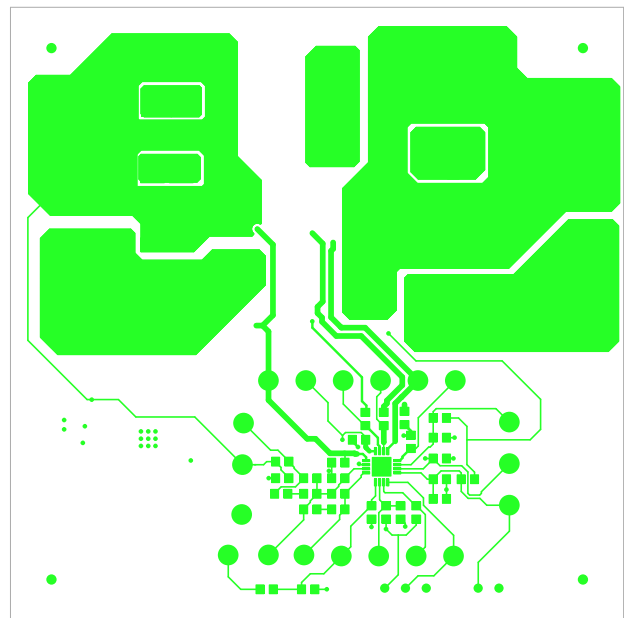

FIGURE 24. TOP LAYER

ISL8117AEVAL1Z PCB Layout (Continued)

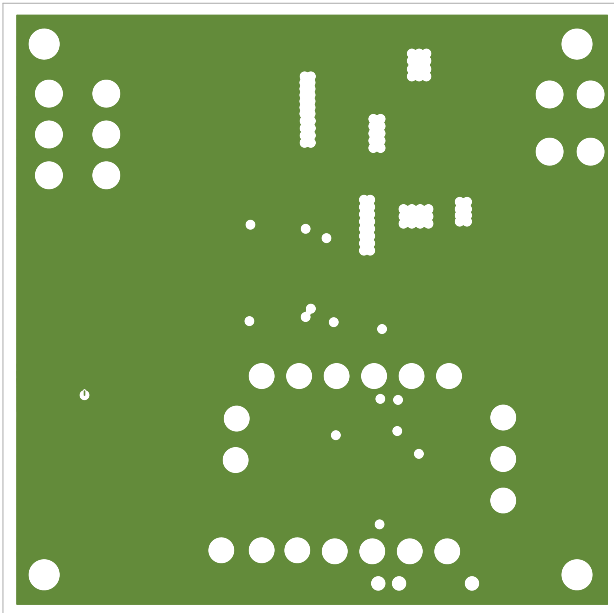

FIGURE 25. SECOND LAYER (SOLID GROUND)

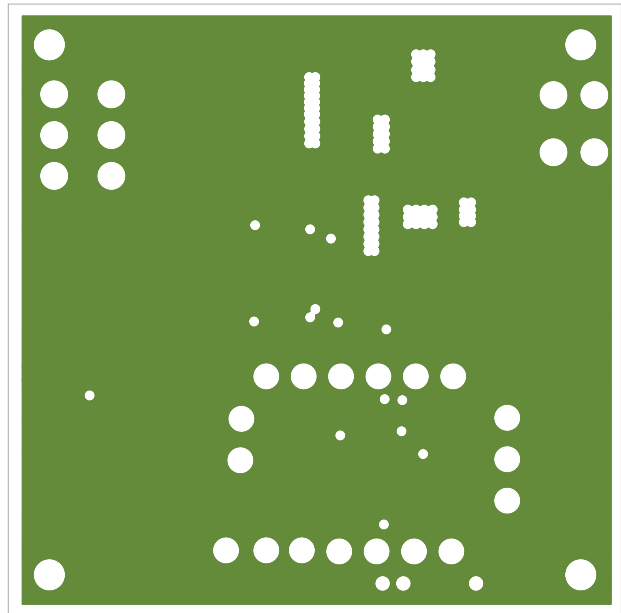

FIGURE 26. THIRD LAYER

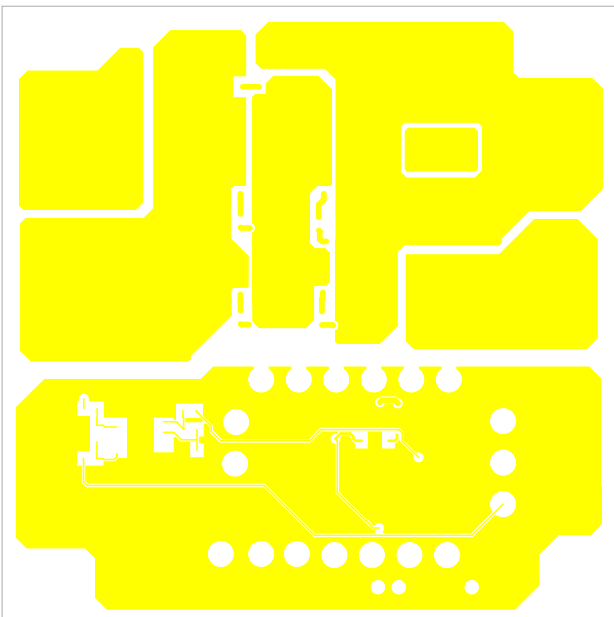

FIGURE 27. BOTTOM LAYER

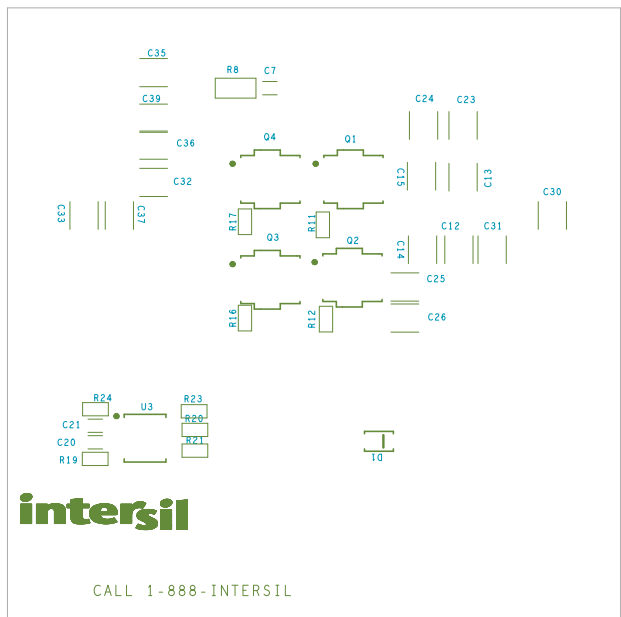

FIGURE 28. SILKSCREEN BOTTOM

Intersil Corporation reserves the right to make changes in circuit design, software and/or specifications at any time without notice. Accordingly, the reader is cautioned to verify that the document is current before proceeding.

For information regarding Intersil Corporation and its products, see www.intersil.com