

PXF60-Single Output DC/DC Converter

18 to 36 Vdc and 36 to 75 Vdc input, 3.3 to 15 Vdc Single Output, 60W



Applications

- Distributed power architectures
- Workstations
- Computer equipment
- Communications equipment

Features

- Single output current up to 14A
- 60 watts maximum output power
- 2:1 wide input voltage range of 18-36 and 36-75VDC
- Six-sided continuous shield
- Case grounding
- High efficiency up to 90%
- Low profile: 2.00×2.00×0.40 inches (50.8×50.8×10.2 mm)
- Fixed switching frequency
- RoHS directive compliant
- Input to output isolation: 1600Vdc,min
- Over-temperature protection
- Input under-voltage protection
- Output over-voltage protection
- Over-current protection, auto-recovery
- Output short circuit protection, auto-recovery
- Remote ON/OFF

Options

- Heat sinks available for extended operation
- Remote ON/OFF logic configuration

General Description

The PXF60-xxSxx single output series offers 60 watts of output power from a 2.00 x 2.00 x 0.4 inch package. This series has a 2:1 wide input voltage of 18-36VDC and 36-75VDC , features 1600VDC of isolation, short-circuit and over-voltage protection, and six sided shielding.

Table of Contents

Absolute Maximum Ratings	P2	Heat Sink Consideration	P25
Output Specification	P2	Remote ON/OFF Control	P26
Input Specification	P3	Mechanical Data	P27
General Specification	P4	Recommended Pad Layout	P27
Characteristic Curves	P5	Output Voltage Adjustment	P28
Test Configurations	P21	Remote Sense Application Circuit	P29
EMC Considerations	P22	Soldering Considerations	P29
Input Source Impedance	P24	Packaging Information	P30
Output Over Current Protection	P24	Part Number Structure	P30
Output Over Voltage Protection	P24	Safety and Installation Instruction	P31
Thermal Consideration	P25	MTBF and Reliability	P31

Absolute Maximum Rating				
Parameter	Model	Min	Max	Unit
Input Voltage	24Sxx 48Sxx		36	Vdc
			75	
Transient (100ms)	24Sxx 48Sxx		50	
			100	
Operating Ambient Temperature (With Derating)	All	-40	110	°C
Operating Case Temperature	All		110	°C
Storage Temperature	All	-55	125	°C

Output Specification					
Parameter	Model	Min	Typ	Max	Unit
Output Voltage (Vin = Vin(nom) ; Full Load ; TA=25°C)	xxS3P3	3.267	3.3	3.333	Vdc
	xxS05	4.95	5	5.05	
	xxS12	11.88	12	12.12	
	xxS15	14.85	15	15.15	
Voltage Adjustability	All	-10		+10	%
Output Regulation Line (Vin(min) to Vin(max) at Full Load) Load (0% to 100% of Full Load)	All	-0.2		+0.2	%
		-0.5		+0.5	
Output Ripple & Noise Peak-to-Peak (5Hz to 20MHz Bandwidth)	xxS3P3			75	mVp-p
	xxS05			75	
	xxS12			100	
	xxS15			100	
Temperature Coefficient	All	-0.02		+0.02	%/°C
Output Voltage Overshoot (Vin = Vin(min) to Vin(max) ; Full Load ; TA=25°C)	All		0	3	% Vo
Dynamic Load Response (Vin = Vin(nom) ; TA=25°C) Load Step Change From 75% to 100% or 100 to 75% of Full Load Peak Deviation Setting Time (Vo < 10% Peak Deviation)	All		200		mV
	All		250		µS
Output Current	xxS3P3	0		14000	mA
	xxS05	0		12000	
	xxS12	0		5000	
	xxS15	0		4000	
Output Over Voltage Protection (Voltage Clamped)	xxS3P3	3.7		5.4	Vdc
	xxS05	5.6		7.0	
	xxS12	13.8		17.5	
	xxS15	16.8		20.5	
Output Over Current Protection	All			150	% FL.
Output Short Circuit Protection	All	Hiccup, Automatic Recovery			

Input Specification						
Parameter	Model	Min	Typ	Max	Unit	
Operating Input Voltage	24Sxx	18	24	36	Vdc	
	48Sxx	36	48	75		
Input Current (Maximum Value at $V_{in} = V_{in(nom)}$; Full Load)	24S3P3		2264		mA	
	24S05		2941			
	24S12		2907			
	24S15		2907			
	48S3P3		1132			
	48S05		1453			
	48S12		1453			
	48S15		1453			
Input Standby Current (Typical Value at $V_{in} = V_{in(nom)}$; No Load)	24S3P3		100		mA	
	24S05		130			
	24S12		150			
	24S15		150			
	48S3P3		80			
	48S05		90			
	48S12		100			
	48S15		100			
Under Voltage Lockout Turn-on Threshold	24Sxx		17		Vdc	
	48Sxx		34			
Under Voltage Lockout Turn-off Threshold	24Sxx		15		Vdc	
	48Sxx		32			
Input Reflected Ripple Current (5 to 20MHz, 12 μ H Source Impedance)	All		20		mAp-p	
Start Up Time ($V_{in} = V_{in(nom)}$ and Constant Resistive Load)	All			20	ms	
						Power Up
						Remote ON/OFF
Remote ON/OFF Control (The ON/OFF pin voltage is referenced to $-V_{IN}$)	All	0		1.2	Vdc	
						Negative Logic DC-DC ON(Short)
						DC-DC OFF(Open)
						Positive Logic DC-DC ON(Open)
						DC-DC OFF(Short)
Remote Off Input Current	ALL		4		mA	
Input Current of Remote Control Pin	ALL	-0.5		1	mA	

General Specification					
Parameter	Model	Min	Typ	Max	Unit
Efficiency (Vin = Vin(nom) ; Full Load ; TA=25°C)	24S3P3		89.0		%
	24S05		90.0		
	24S12		90.0		
	24S15		90.0		
	48S3P3		89.0		
	48S05		90.0		
	48S12		90.0		
	48S15		90.0		
Isolation Voltage Input to Output Input to Case, Output to Case	All	1600			Vdc
Isolation Resistance	All	1			GΩ
Isolation Capacitance	All			1500	pF
Switching Frequency	All		300		KHz
Weight	All		60.0		g
MTBF Bellcore TR-NWT-000332, TC=40°C MIL-HDBK-217F	All		1.093×10 ⁶ 1.096×10 ⁵		hours

Characteristic Curves

All test conditions are at 25°C. The figures are for PXF60-24S3P3

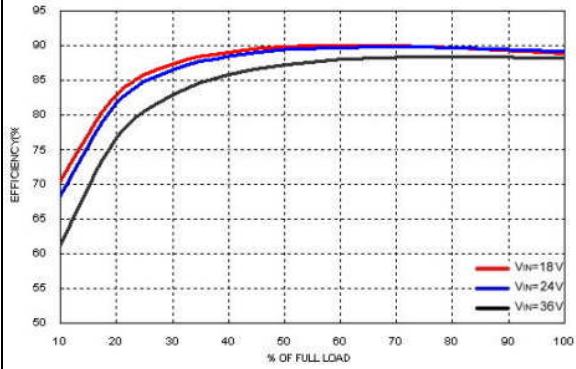

Efficiency Versus Output Current

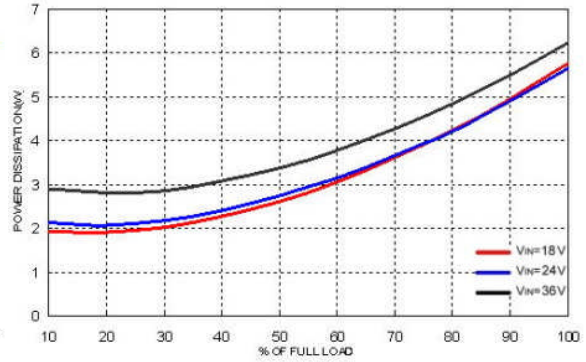

Power Dissipation Versus Output Current

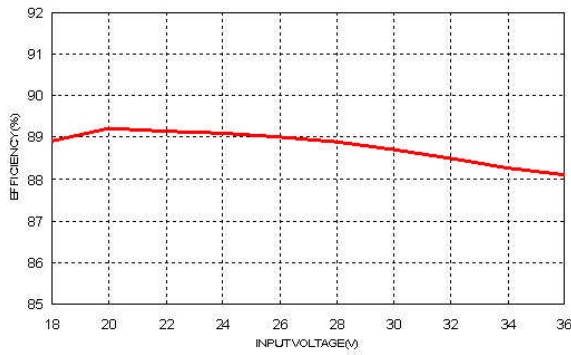

Efficiency Versus Input Voltage. Full Load

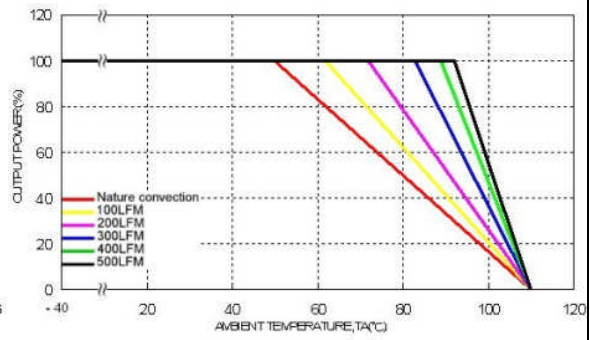

Derating Output Current Versus Ambient Temperature and Airflow
Vin = Vin(nom)

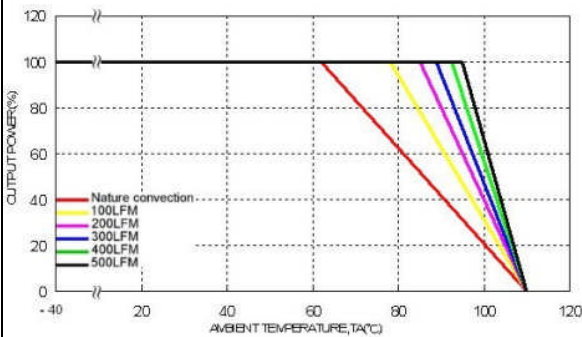

Derating Output Current Versus Ambient Temperature with Heat-Sink
and Airflow Vin = Vin(nom)

Characteristic Curves (Continued)

All test conditions are at 25°C. The figures are for PXF60-24S3P3

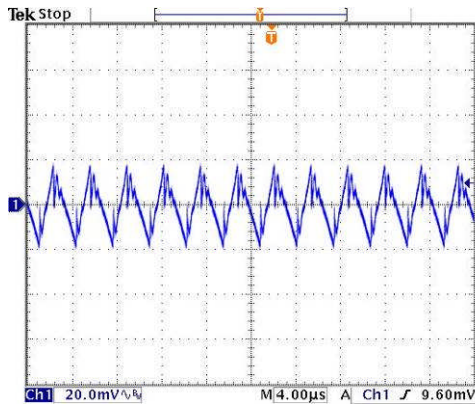

Typical Output Ripple and Noise.
 $V_{in} = V_{in}(nom)$, Full Load

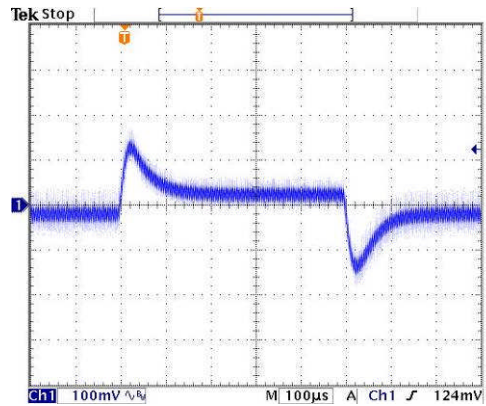

Transient Response to Dynamic Load Change from 100% to 75% to 100% of Full Load ; $V_{in} = V_{in}(nom)$

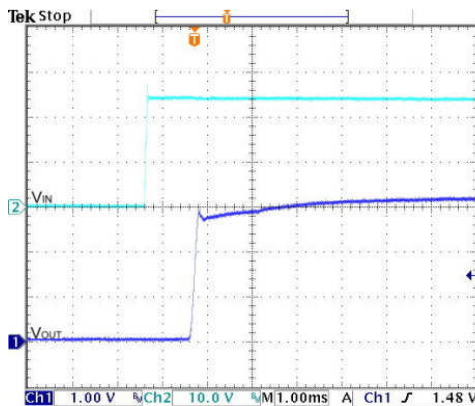

Typical Input Start-Up and Output Rise Characteristic
 $V_{in} = V_{in}(nom)$, Full Load

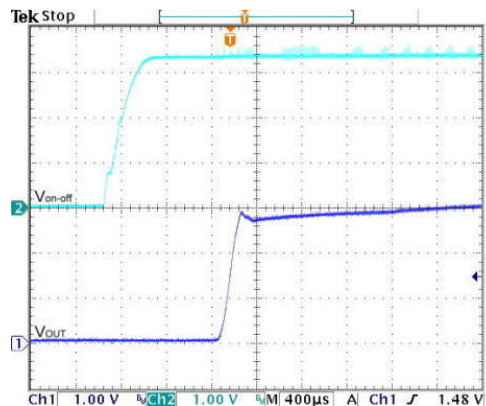

Using ON/OFF Voltage Start-Up and V_o Rise Characteristic
 $V_{in} = V_{in}(nom)$, Full Load

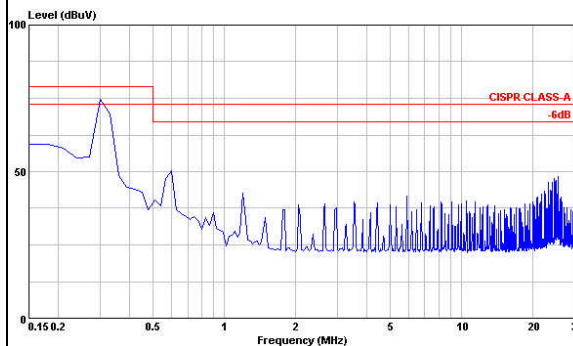

Conduction Emission of EN55022 Class A
 $V_{in} = V_{in}(nom)$, Full Load

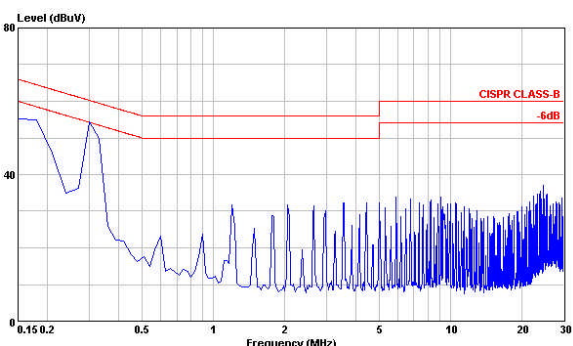

Conduction Emission of EN55022 Class B
 $V_{in} = V_{in}(nom)$, Full Load

Characteristic Curves (Continued)

All test conditions are at 25°C. The figures are for PXF60-24S05

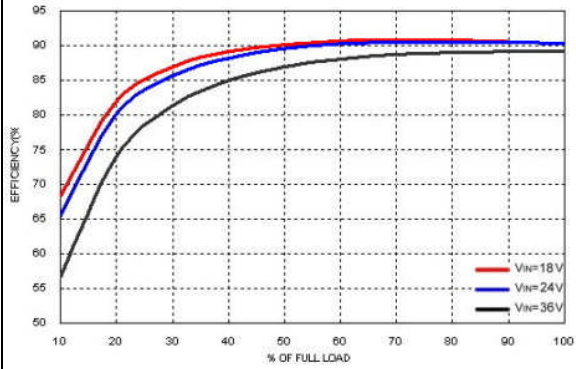

Efficiency Versus Output Current

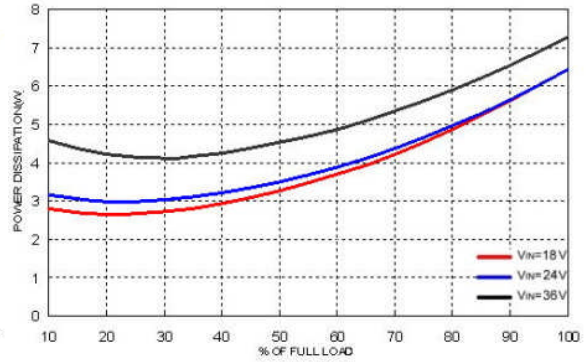

Power Dissipation Versus Output Current

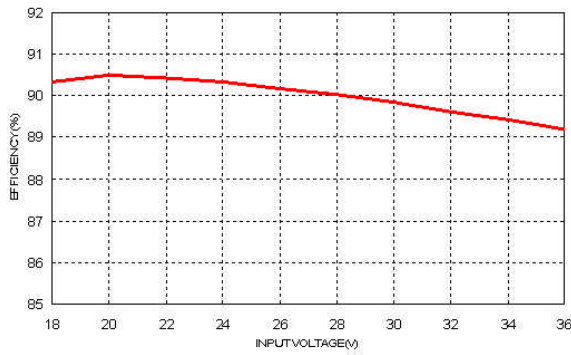

Efficiency Versus Input Voltage. Full Load

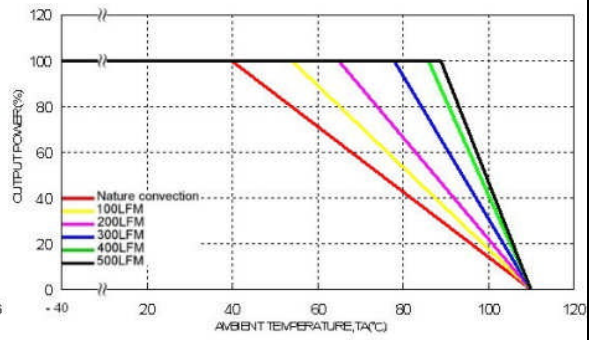

Derating Output Current Versus Ambient Temperature and Airflow
Vin=Vin(nom)

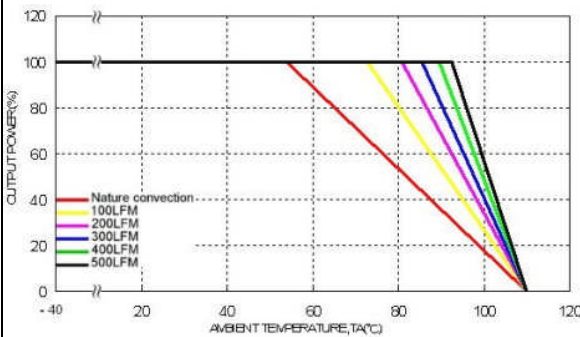

Derating Output Current Versus Ambient Temperature with Heat-Sink
and Airflow Vin = Vin(nom)

Characteristic Curves (Continued)

All test conditions are at 25°C. The figures are for PXF60-24S05

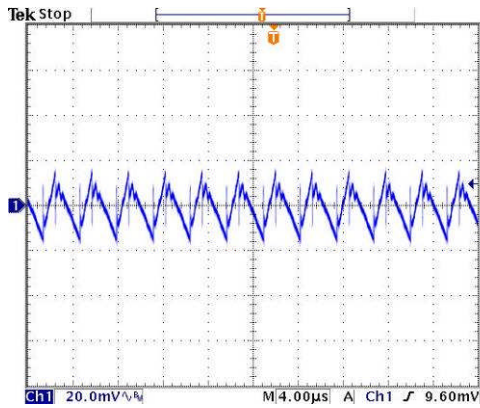

Typical Output Ripple and Noise.
Vin=Vin(nom), Full Load

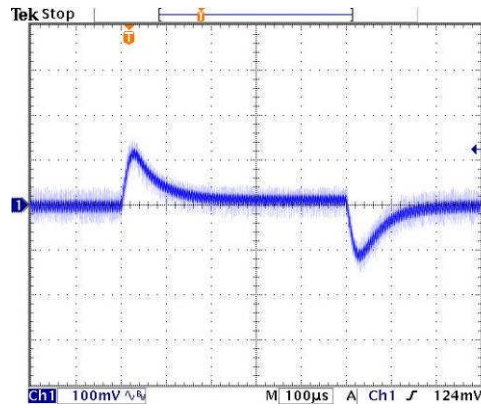

Transient Response to Dynamic Load Change from 100% to 75% to 100% of Full Load ; Vin=Vin(nom)

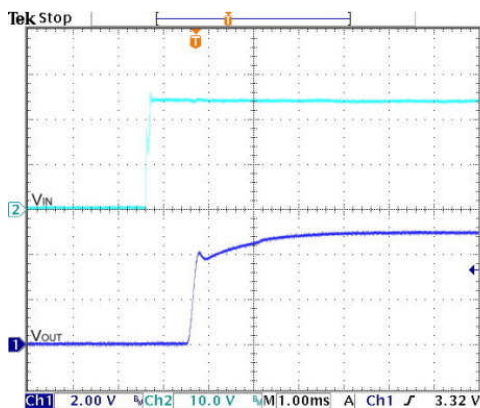

Typical Input Start-Up and Output Rise Characteristic
Vin=Vin(nom), Full Load

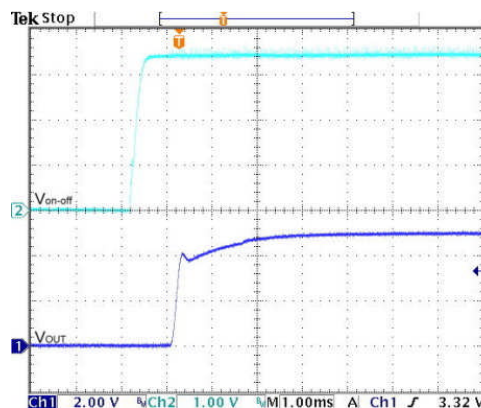

Using ON/OFF Voltage Start-Up and Vo Rise Characteristic
Vin=Vin(nom), Full Load

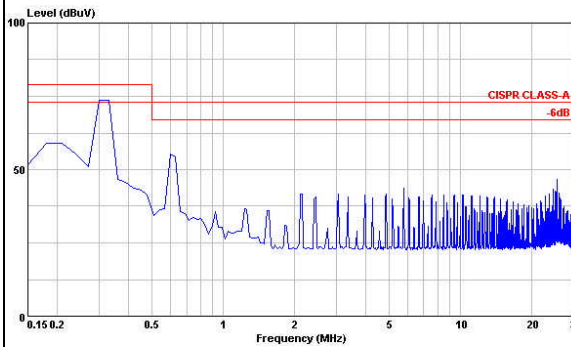

Conduction Emission of EN55022 Class A
Vin=Vin(nom), Full Load

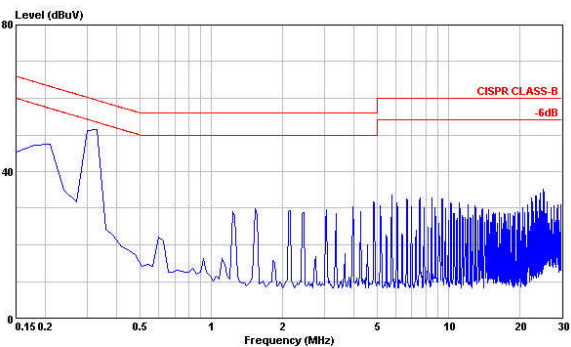

Conduction Emission of EN55022 Class B
Vin=Vin(nom), Full Load

Characteristic Curves (Continued)

All test conditions are at 25°C. The figures are for PXF60-24S12

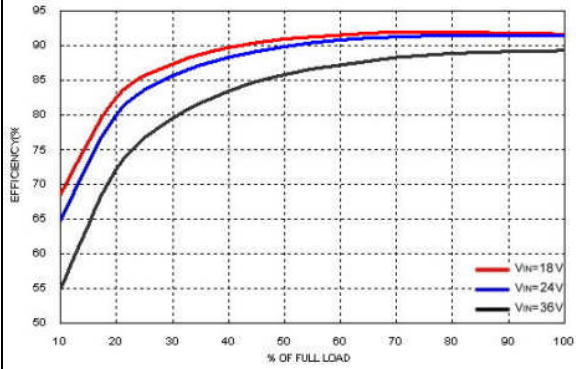

Efficiency Versus Output Current

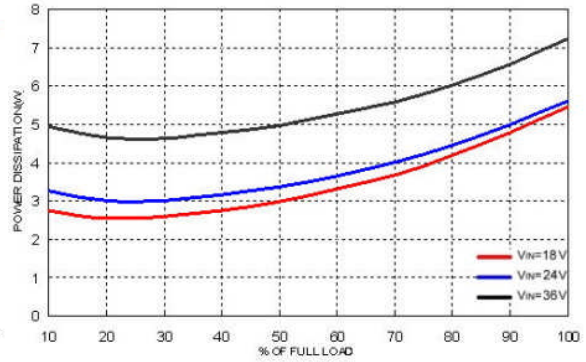

Power Dissipation Versus Output Current

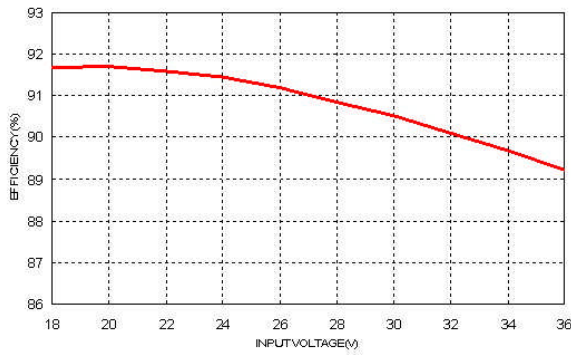

Efficiency Versus Input Voltage. Full Load

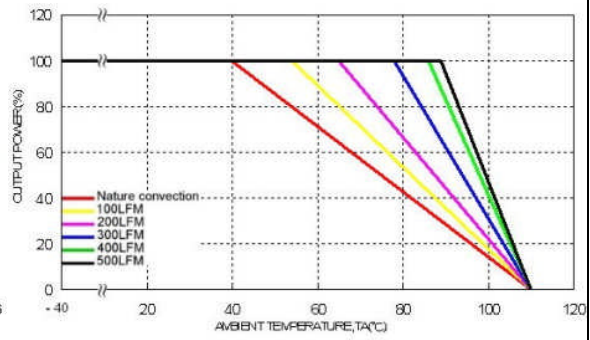

Derating Output Current Versus Ambient Temperature and Airflow
Vin=Vin(nom)

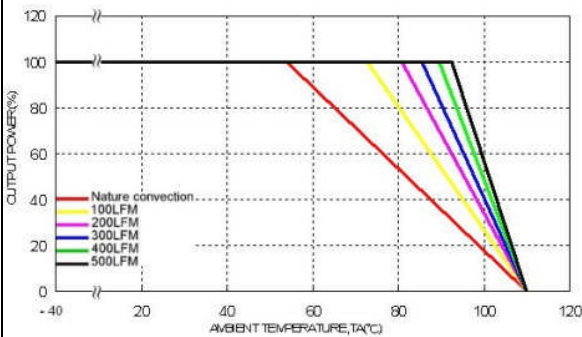

Derating Output Current Versus Ambient Temperature with Heat-Sink
and Airflow Vin = Vin(nom)

Characteristic Curves (Continued)

All test conditions are at 25°C. The figures are for PXF60-24S12

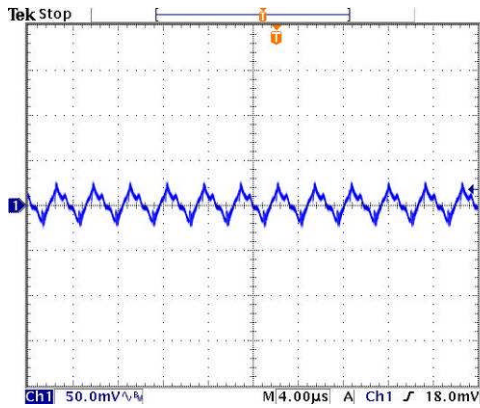

Typical Output Ripple and Noise.
Vin=Vin(nom), Full Load

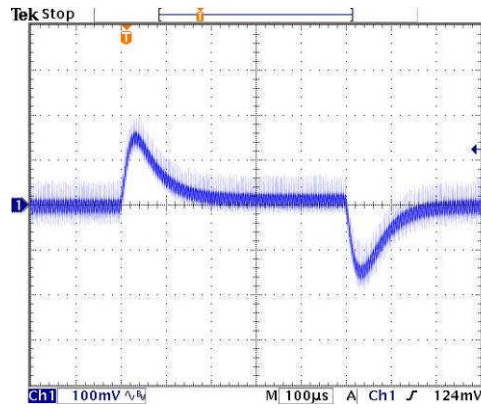

Transient Response to Dynamic Load Change from 100% to 75% to 100% of Full Load ; Vin=Vin(nom)

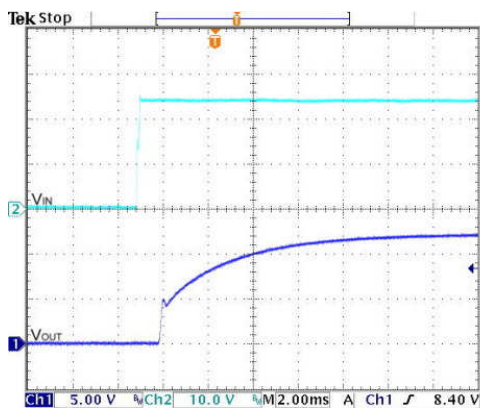

Typical Input Start-Up and Output Rise Characteristic
Vin=Vin(nom), Full Load

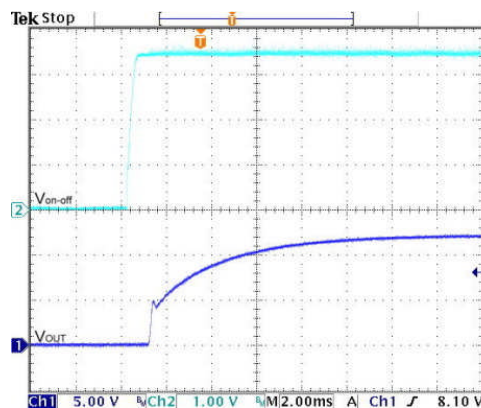

Using ON/OFF Voltage Start-Up and Vo Rise Characteristic
Vin=Vin(nom), Full Load

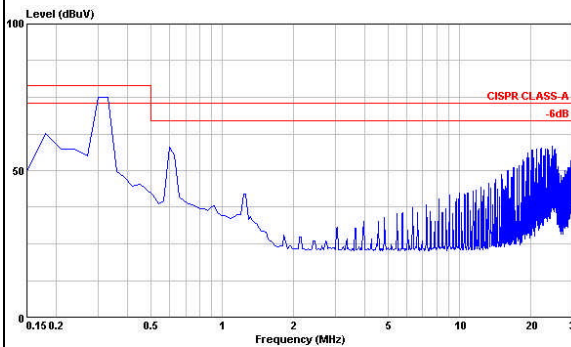

Conduction Emission of EN55022 Class A
Vin=Vin(nom), Full Load

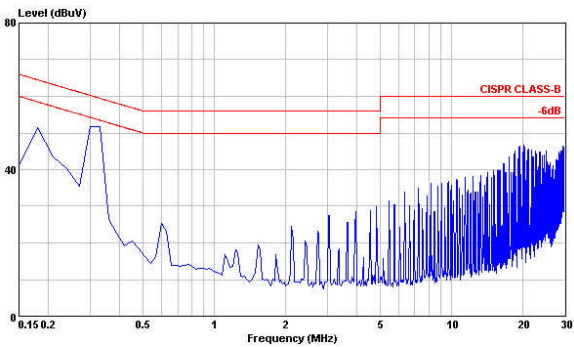

Conduction Emission of EN55022 Class B
Vin=Vin(nom), Full Load

Characteristic Curves (Continued)

All test conditions are at 25°C. The figures are for PXF60-24S15

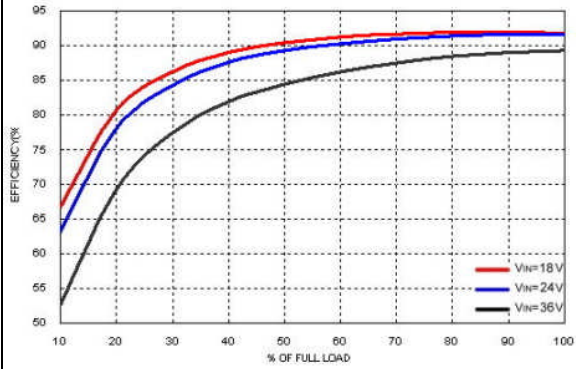

Efficiency Versus Output Current

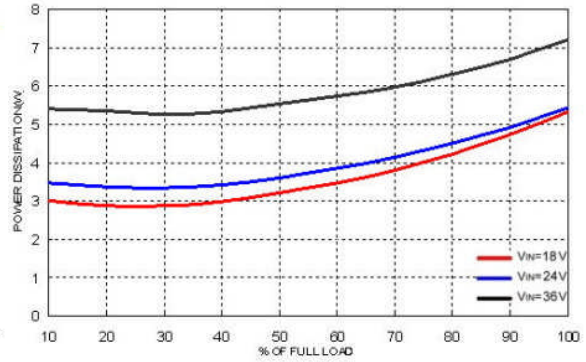

Power Dissipation Versus Output Current

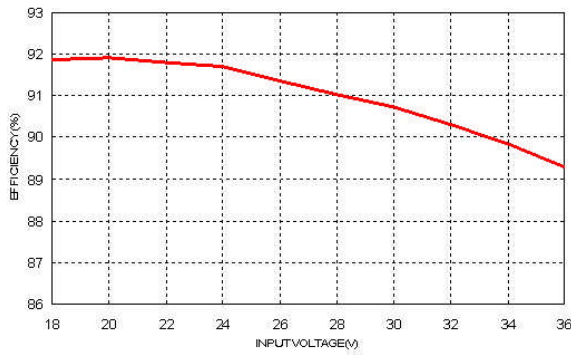

Efficiency Versus Input Voltage. Full Load

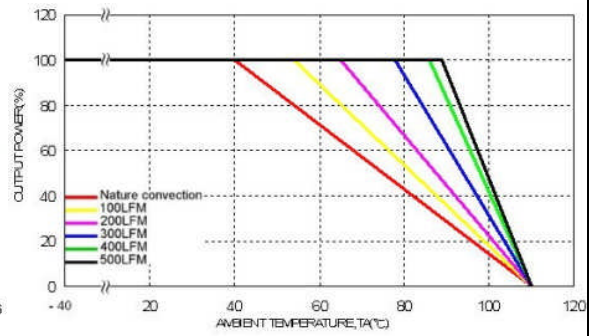

Derating Output Current Versus Ambient Temperature and Airflow
Vin=Vin(nom)

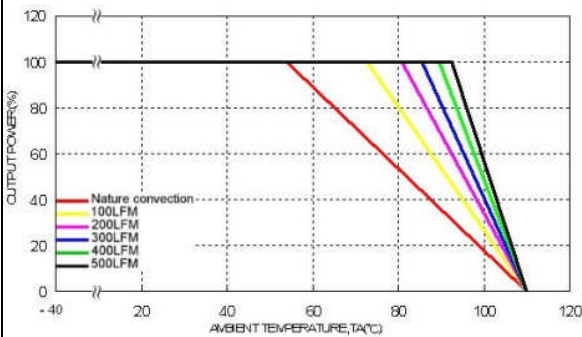

Derating Output Current Versus Ambient Temperature with Heat-Sink
and Airflow Vin = Vin(nom)

Characteristic Curves (Continued)

All test conditions are at 25°C. The figures are for PXF60-24S15

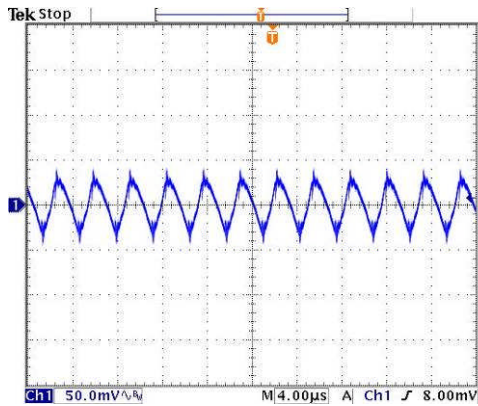

Typical Output Ripple and Noise.
Vin=Vin(nom), Full Load

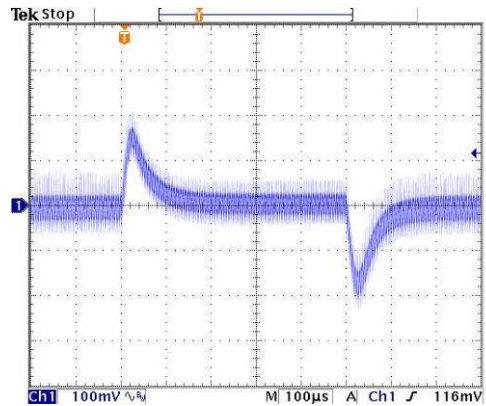

Transient Response to Dynamic Load Change from 100% to 75% to 100% of Full Load ; Vin=Vin(nom)

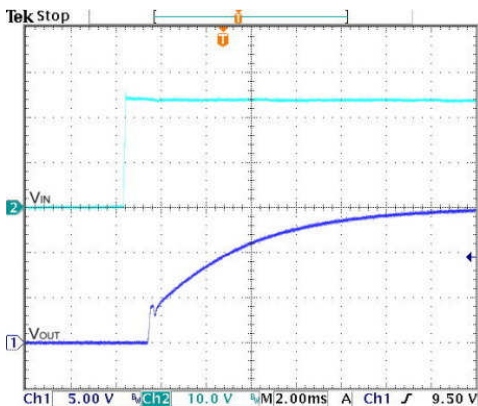

Typical Input Start-Up and Output Rise Characteristic
Vin=Vin(nom), Full Load

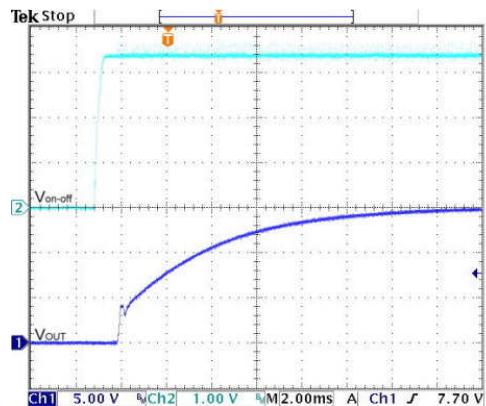

Using ON/OFF Voltage Start-Up and Vo Rise Characteristic
Vin=Vin(nom), Full Load

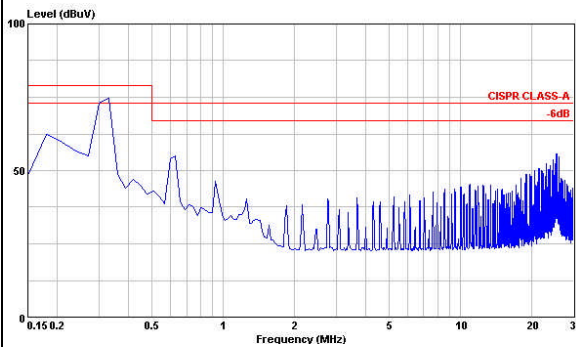

Conduction Emission of EN55022 Class A
Vin=Vin(nom), Full Load

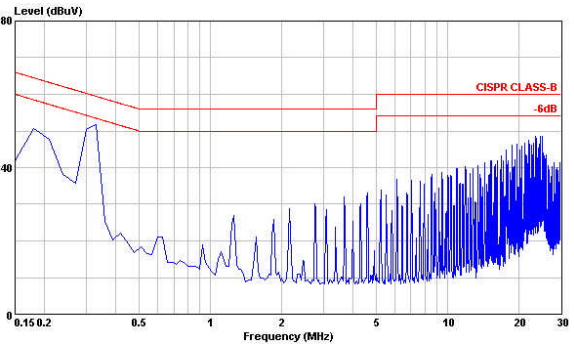

Conduction Emission of EN55022 Class B
Vin=Vin(nom), Full Load

Characteristic Curves (Continued)

All test conditions are at 25°C. The figures are for PXF60-48S3P3

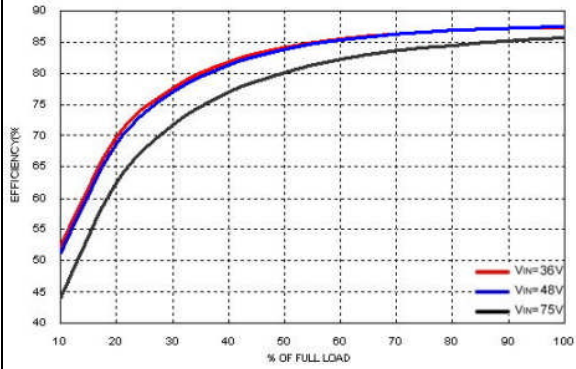

Efficiency Versus Output Current

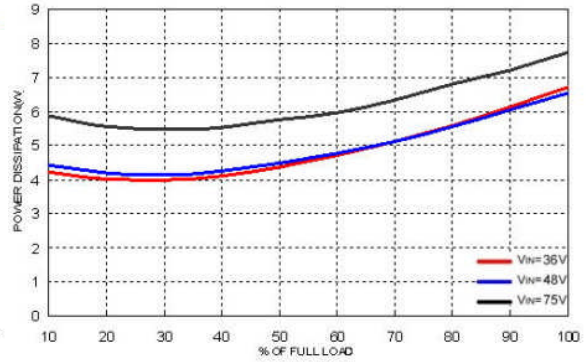

Power Dissipation Versus Output Current

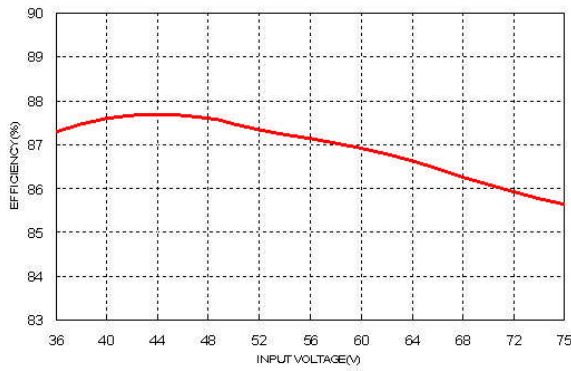

Efficiency Versus Input Voltage. Full Load

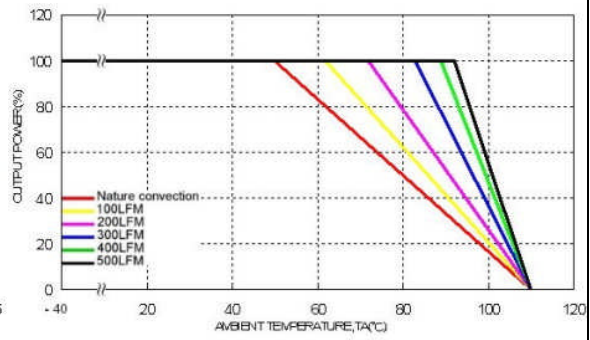

Derating Output Current Versus Ambient Temperature and Airflow
Vin=Vin(nom)

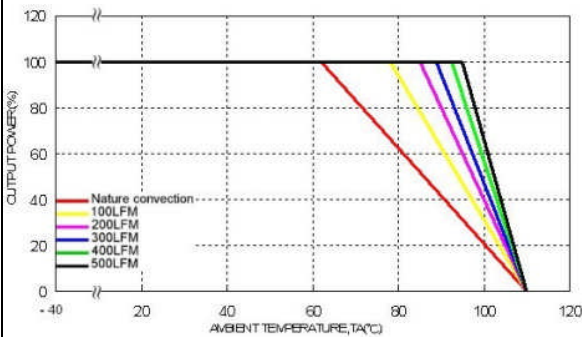

Derating Output Current Versus Ambient Temperature with Heat-Sink
and Airflow Vin = Vin(nom)

Characteristic Curves (Continued)

All test conditions are at 25°C. The figures are for PXF60-48S3P3

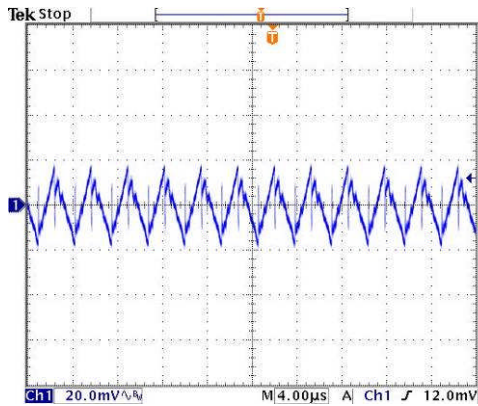

Typical Output Ripple and Noise.
Vin=Vin(nom), Full Load

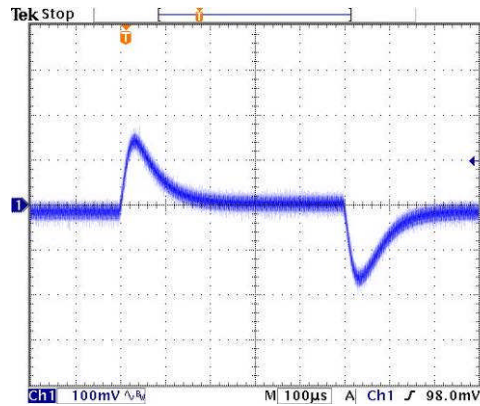

Transient Response to Dynamic Load Change from 100% to 75% to 100% of Full Load ; Vin=Vin(nom)

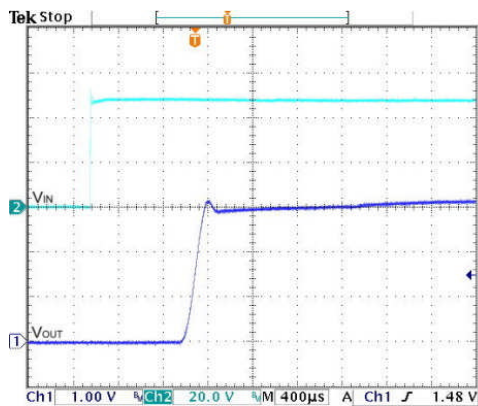

Typical Input Start-Up and Output Rise Characteristic
Vin=Vin(nom), Full Load

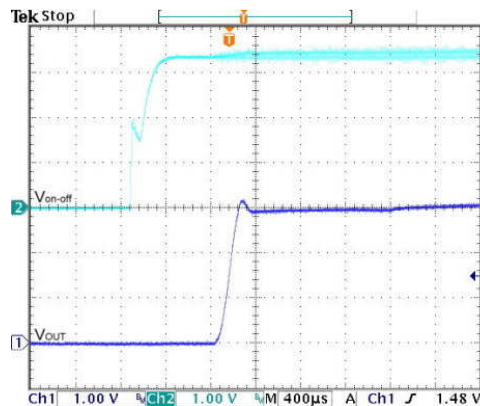

Using ON/OFF Voltage Start-Up and V_O Rise Characteristic
Vin=Vin(nom), Full Load

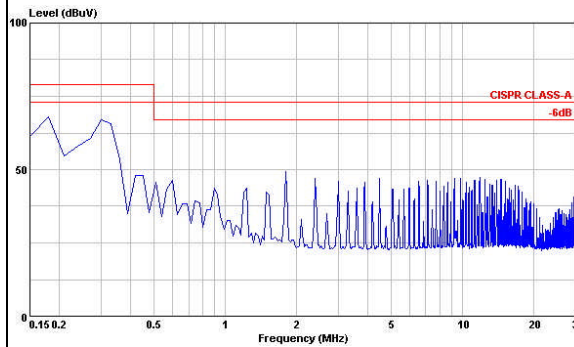

Conduction Emission of EN55022 Class A
Vin=Vin(nom), Full Load

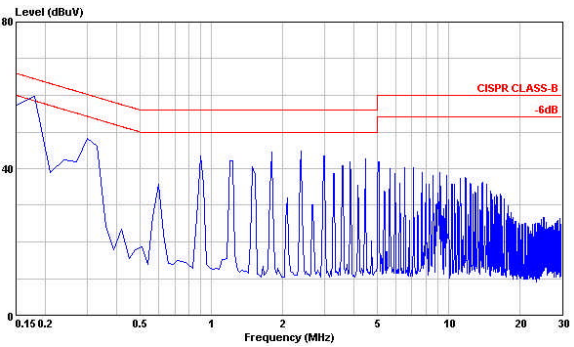

Conduction Emission of EN55022 Class B
Vin=Vin(nom), Full Load

Characteristic Curves (Continued)

All test conditions are at 25°C. The figures are for PXF60-48S05

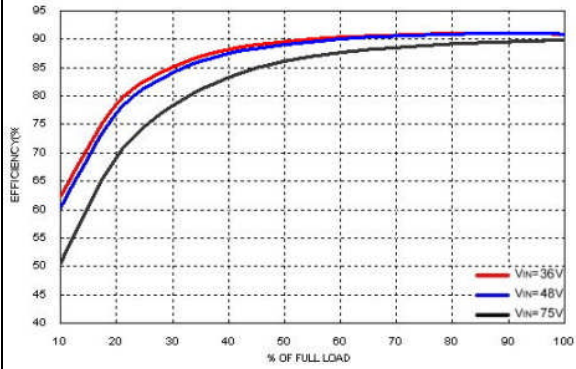

Efficiency Versus Output Current

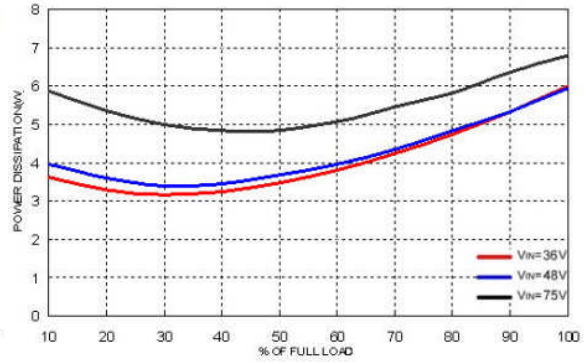

Power Dissipation Versus Output Current

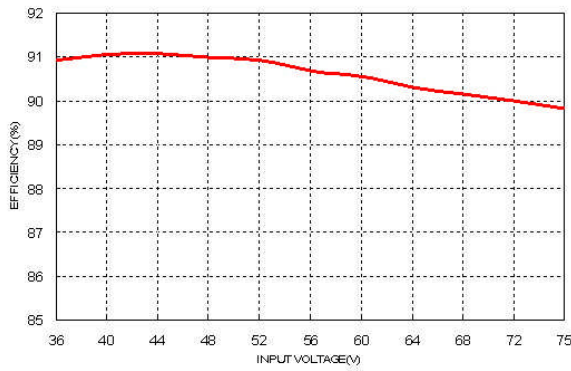

Efficiency Versus Input Voltage. Full Load

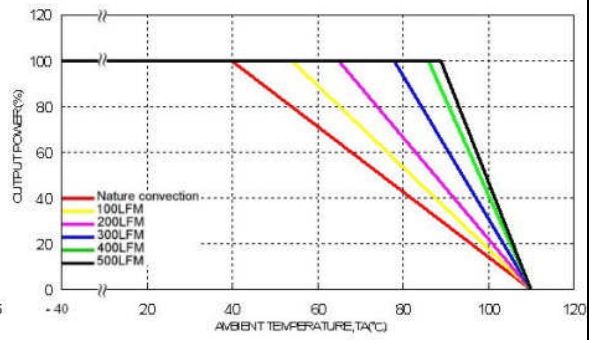

Derating Output Current Versus Ambient Temperature and Airflow
Vin=Vin(nom)

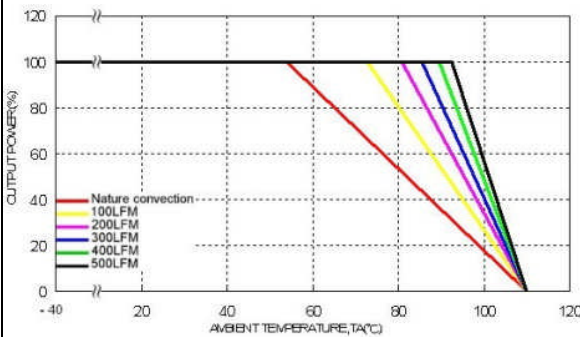

Derating Output Current Versus Ambient Temperature with Heat-Sink
and Airflow Vin = Vin(nom)

Characteristic Curves (Continued)

All test conditions are at 25°C. The figures are for PXF60-48S05

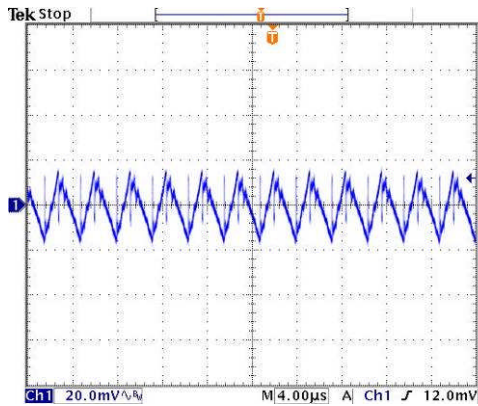

Typical Output Ripple and Noise.
Vin=Vin(nom), Full Load

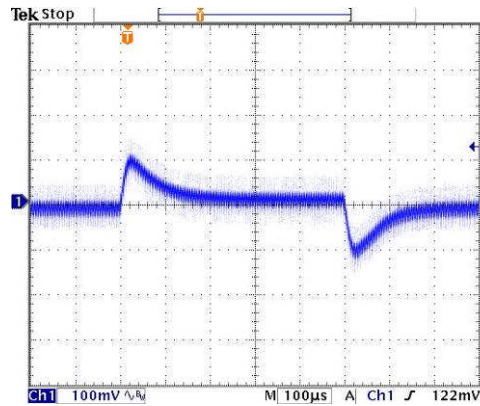

Transient Response to Dynamic Load Change from 100% to 75% to 100% of Full Load ; Vin=Vin(nom)

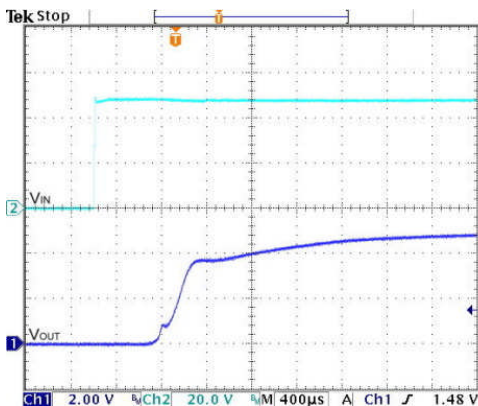

Typical Input Start-Up and Output Rise Characteristic
Vin=Vin(nom), Full Load

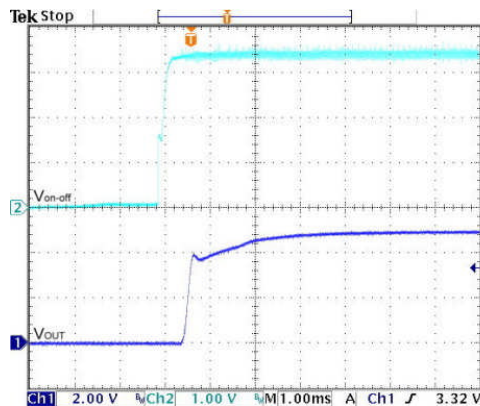

Using ON/OFF Voltage Start-Up and Vo Rise Characteristic
Vin=Vin(nom), Full Load

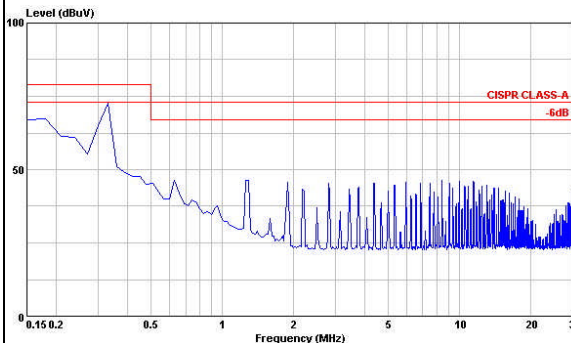

Conduction Emission of EN55022 Class A
Vin=Vin(nom), Full Load

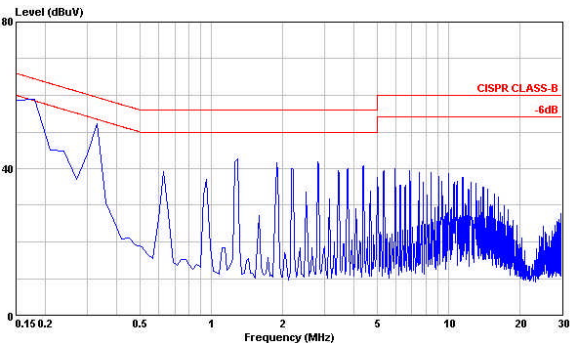

Conduction Emission of EN55022 Class B
Vin=Vin(nom), Full Load

Characteristic Curves (Continued)

All test conditions are at 25°C. The figures are for PXF60-48S12

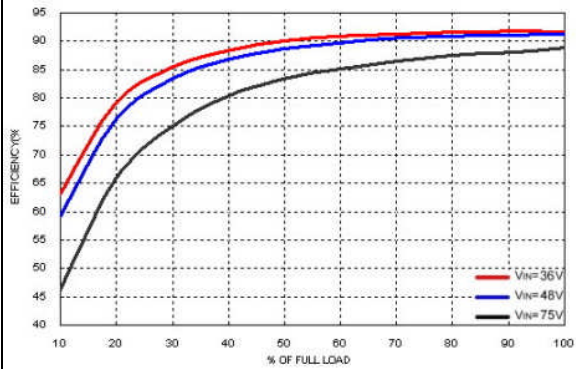

Efficiency Versus Output Current

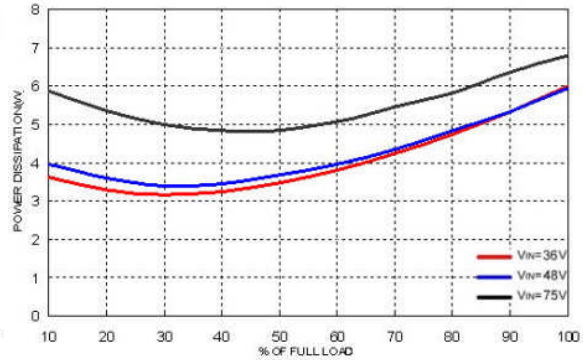

Power Dissipation Versus Output Current

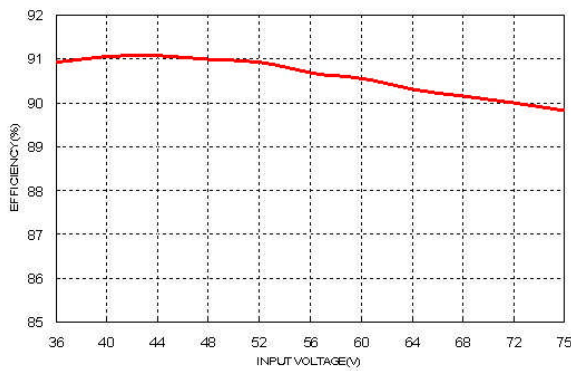

Efficiency Versus Input Voltage. Full Load

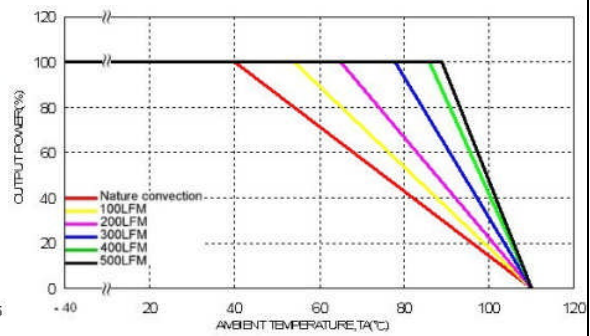

Derating Output Current Versus Ambient Temperature and Airflow
Vin=Vin(nom)

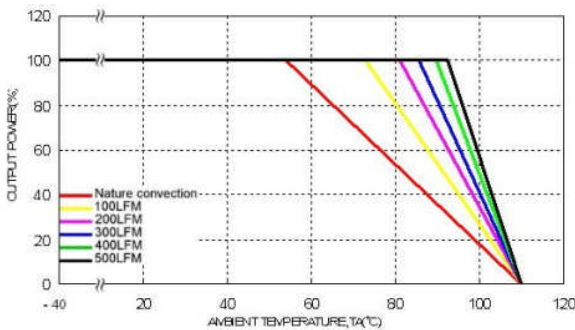

Derating Output Current Versus Ambient Temperature with Heat-Sink
and Airflow Vin = Vin(nom)

Characteristic Curves (Continued)

All test conditions are at 25°C. The figures are for PXF60-48S12

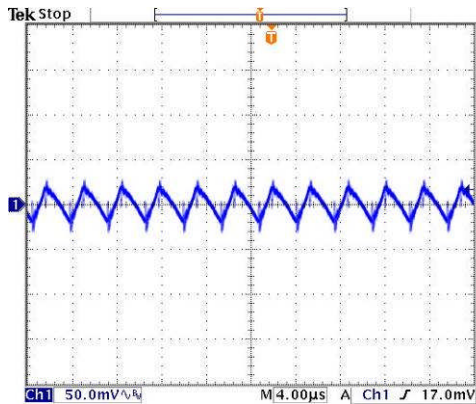

Typical Output Ripple and Noise.
Vin=Vin(nom), Full Load

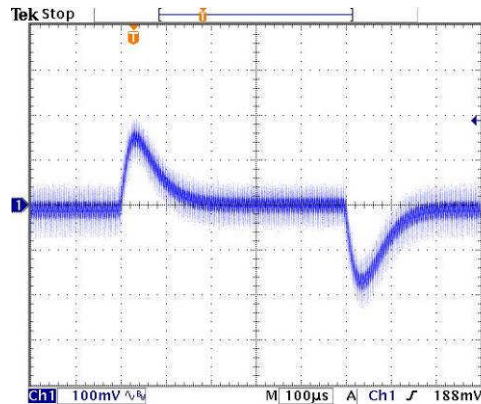

Transient Response to Dynamic Load Change from 100% to 75% to 100% of Full Load ; Vin=Vin(nom)

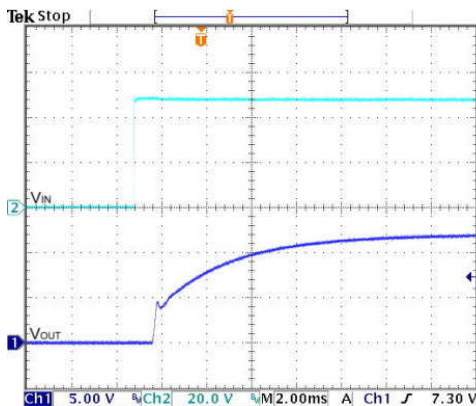

Typical Input Start-Up and Output Rise Characteristic
Vin=Vin(nom), Full Load

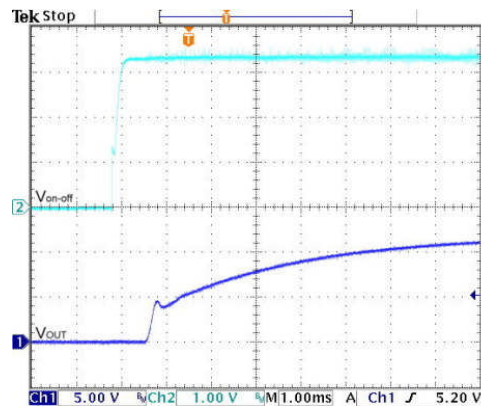

Using ON/OFF Voltage Start-Up and Vo Rise Characteristic
Vin=Vin(nom), Full Load

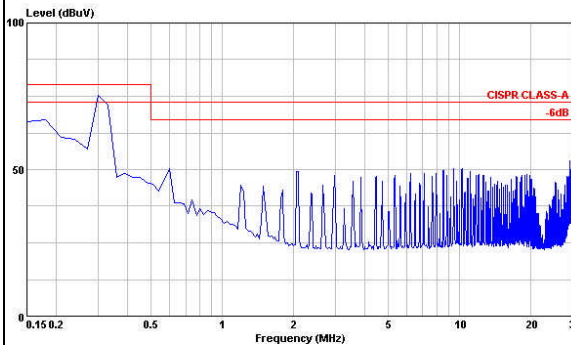

Conduction Emission of EN55022 Class A
Vin=Vin(nom), Full Load

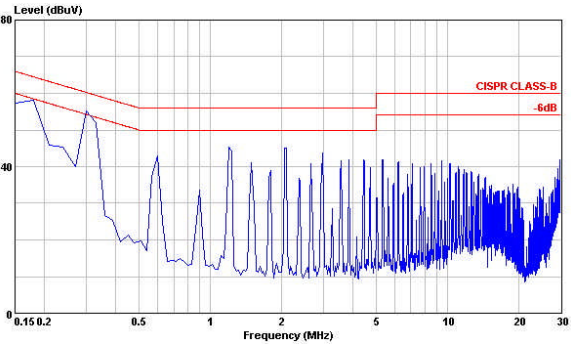

Conduction Emission of EN55022 Class B
Vin=Vin(nom), Full Load

Characteristic Curves (Continued)

All test conditions are at 25°C. The figures are for PXF60-48S15

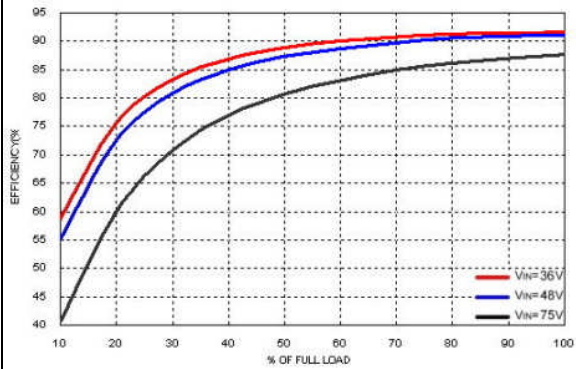

Efficiency Versus Output Current

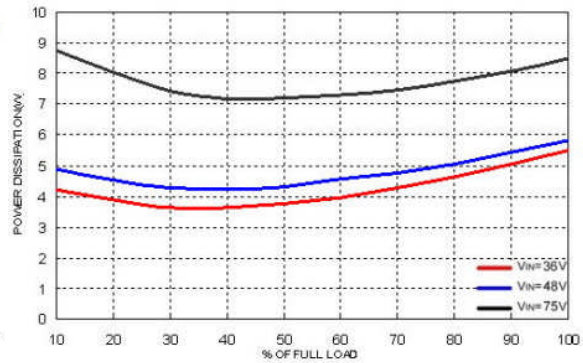

Power Dissipation Versus Output Current

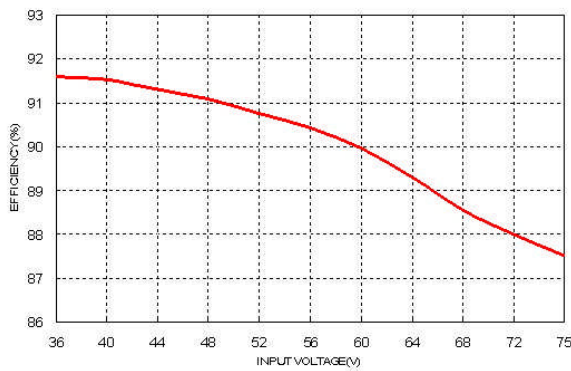

Efficiency Versus Input Voltage. Full Load

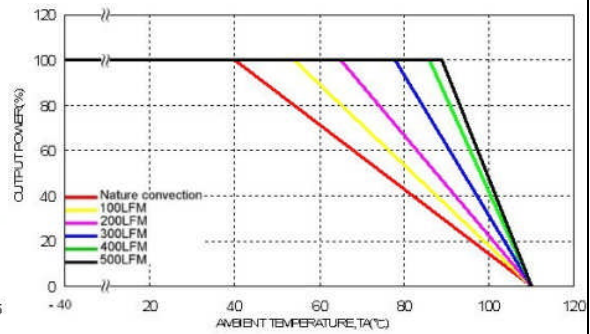

Derating Output Current Versus Ambient Temperature and Airflow
Vin=Vin(nom)

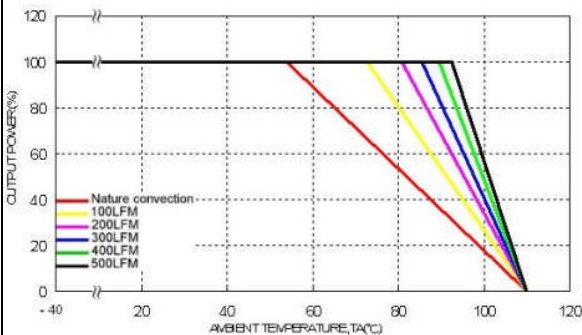

Derating Output Current Versus Ambient Temperature with Heat-Sink
and Airflow Vin = Vin(nom)

Characteristic Curves (Continued)

All test conditions are at 25°C. The figures are for PXF60-48S15

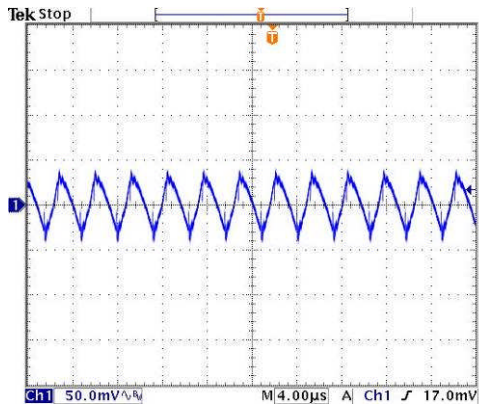

Typical Output Ripple and Noise.
Vin=Vin(nom), Full Load

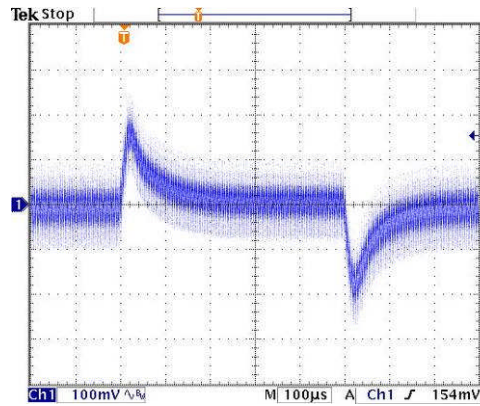

Transient Response to Dynamic Load Change from 100% to 75% to 100% of Full Load ; Vin=Vin(nom)

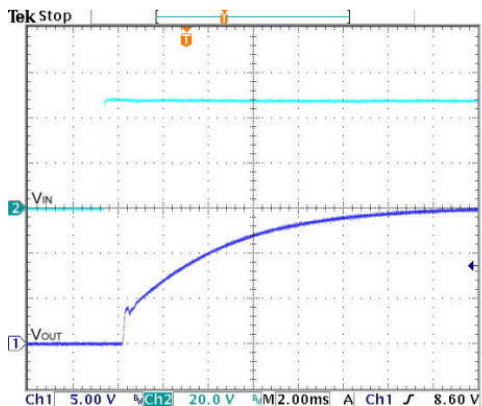

Typical Input Start-Up and Output Rise Characteristic
Vin=Vin(nom), Full Load

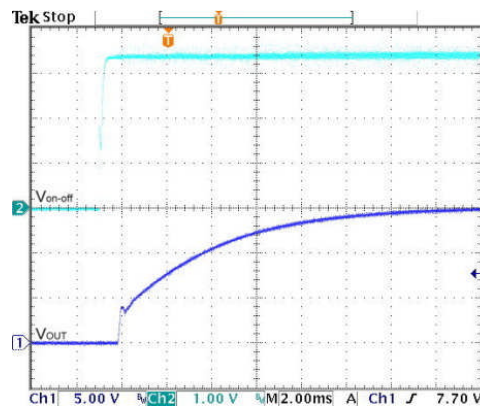

Using ON/OFF Voltage Start-Up and Vo Rise Characteristic
Vin=Vin(nom), Full Load

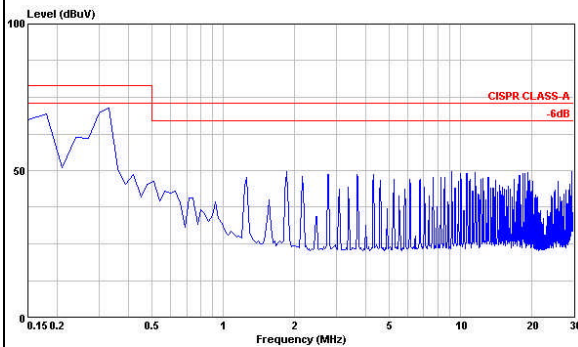

Conduction Emission of EN55022 Class A
Vin=Vin(nom), Full Load

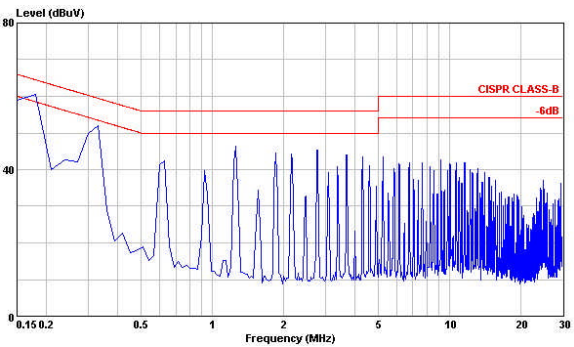

Conduction Emission of EN55022 Class B
Vin=Vin(nom), Full Load

Testing Configurations

Input reflected-ripple current measurement test

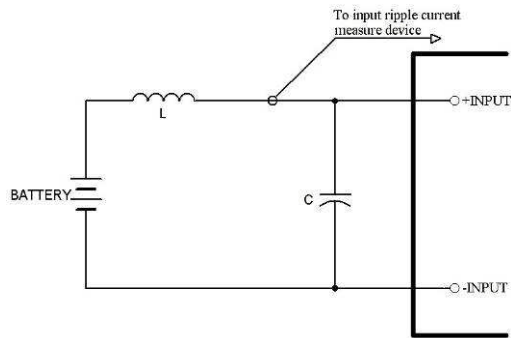

Component	Value	Voltage	Reference
L	12μH	---	---
C	47μF	100V	Aluminum Electrolytic Capacitor

Peak-to-peak output ripple & noise measurement test

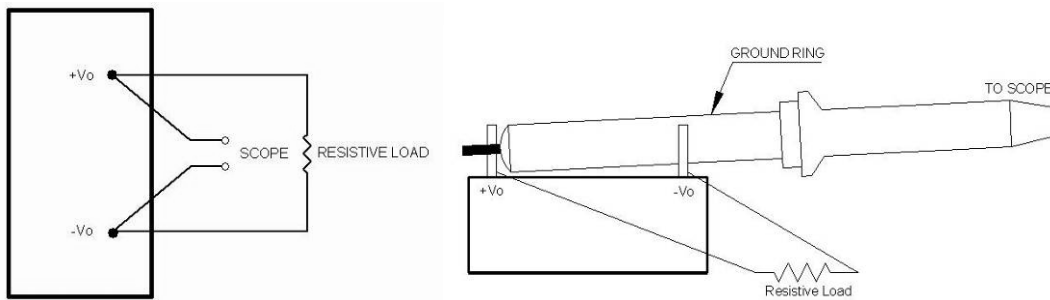

Output voltage and efficiency measurement test

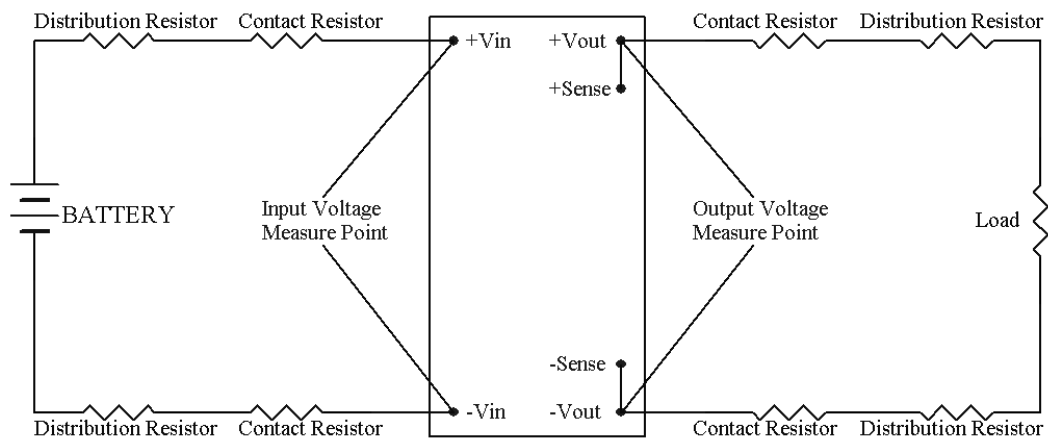

Note: All measurements are taken at the module terminals.

$$Efficiency = \left(\frac{V_o \times I_o}{V_{in} \times I_{in}} \right) \times 100\%$$

EMC considerations

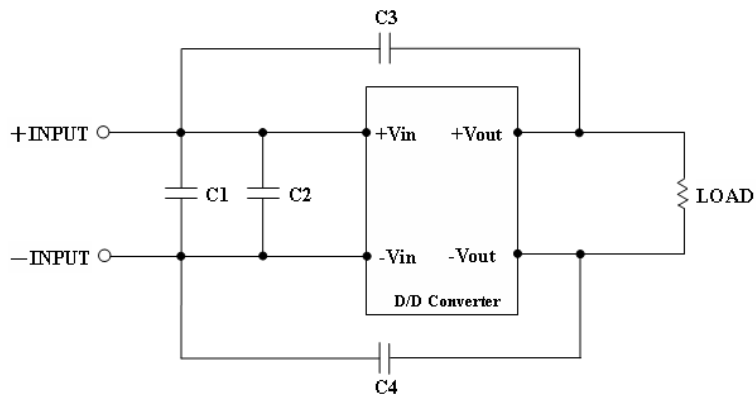

Suggested Schematic for EN55022 Conducted Emission Class A Limits

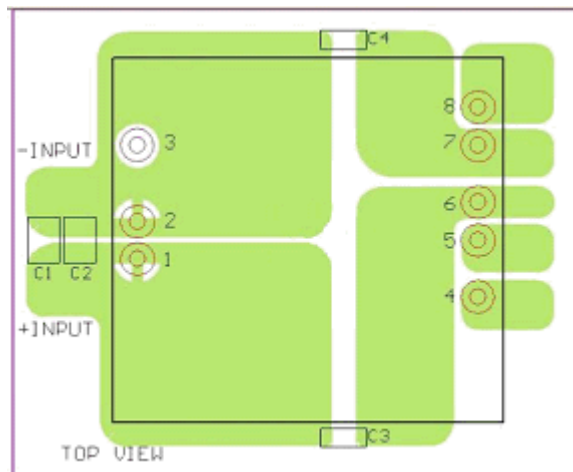

Recommended Layout with Input Filter

To meet conducted emissions EN55022 CLASS A needed the following components:

PXF60-24Sxx

Component	Value	Voltage	Reference
C2	6.8uF	50V	1812 MLCC
C3,C4	1000pF	2KV	1808MLCC

PXF60-48Sxx

Component	Value	Voltage	Reference
C1,C2	2.2uF	100V	1812 MLCC
C3,C4	1000pF	2KV	1808 MLCC

EMC considerations (Continued)

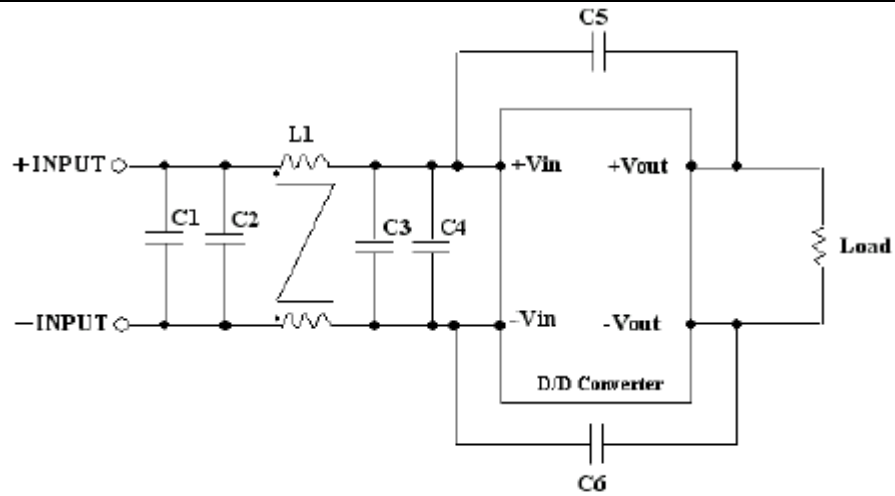

Suggested Schematic for EN55022 Conducted Emission Class B Limits

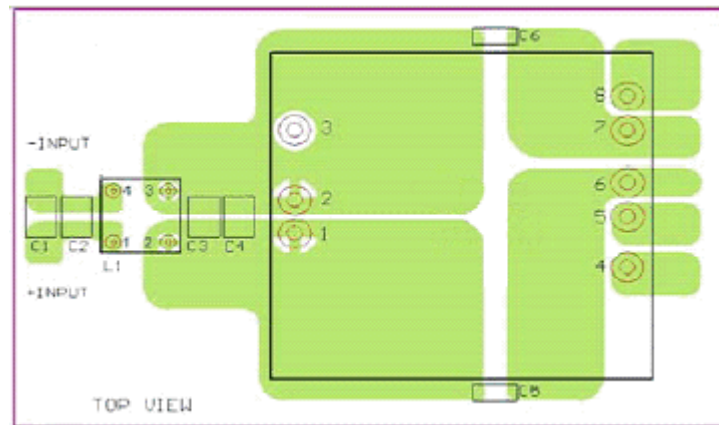

Recommended Layout with Input Filter

EMC considerations (Continued)

To meet conducted emissions EN55022 CLASS B needed the following components :

PXF60-24Sxx

Component	Value	Voltage	Reference
C1,C3	4.7uF	50V	1812 MLCC
C5,C6	1000pF	2KV	1808 MLCC
L1	450uH	----	

PXF60-48Sxx

Component	Value	Voltage	Reference
C1,C2,C3	2.2uF	100V	1812 MLCC
C5,C6	1000pF	2KV	1808MLCC
L1	830uH	----	

This Common Choke L1 has been defined as follow:

- L: 450 μ H \pm 35% / DCR: 25m Ω , max
A height: 9.8 mm, Max
- L: 830 μ H \pm 35% / DCR: 31m Ω , max
A height: 8.8 mm, Max
- Test condition: 100KHz / 100mV
- Recommended through hole: Φ 0.8mm

■ All dimensions in millimeters

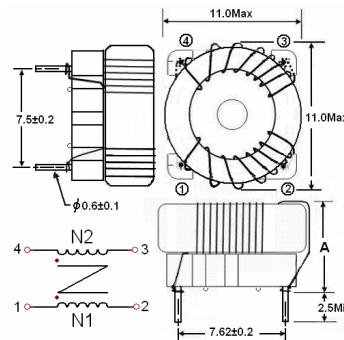

Input Source Impedance

The converter should be connected to a low impedance input source. A highly inductive source impedance can affect the stability of the converter. An input external L-C filter is recommended to minimize input reflected ripple current. The inductor has a simulated source impedance of 12 μ H and the capacitor is Nippon chemi-con KZE series 47 μ F/100V. The capacitor must be located as close as possible to the input terminals of the converter for the lowest impedance.

Output Over Current Protection

When excessive output currents occur in the system, circuit protection is required on all converters. Normally, overload current is maintained at approximately 150 percent of rated current for PXF60 single output series.

Hiccup-mode is a method of operation to protect the converter from being damaged during an over-current fault condition. It also enables the converter to restart when the fault is removed.

One of the problems resulting from over current is that excessive heat may be generated in power devices; especially MOSFET and Schottky diodes and the temperature of these devices may exceed their specified limits. A protection mechanism has to be employed to prevent those power devices from being damaged.

Output Over Voltage Protection

The output over-voltage protection consists of a Zener diode that monitors the output voltage on the feedback loop. If the voltage on the output terminals exceeds the over-voltage protection threshold, then the Zener diode will send a signal to the control IC to limit the output voltage.

Thermal Consideration

The converter operates in a variety of thermal environments. Sufficient cooling should be provided to help ensure reliable operation of the unit. Heat is removed by conduction, convection, and radiation to the surrounding environment. Proper cooling can be verified by measuring the point as the figure below. The temperature at this location should not exceed 110°C. When operating, adequate cooling must be provided to maintain the test point temperature at or below 110°C. Although the maximum point temperature of the power modules is 110°C, limiting this temperature to a lower value will increase the reliability.

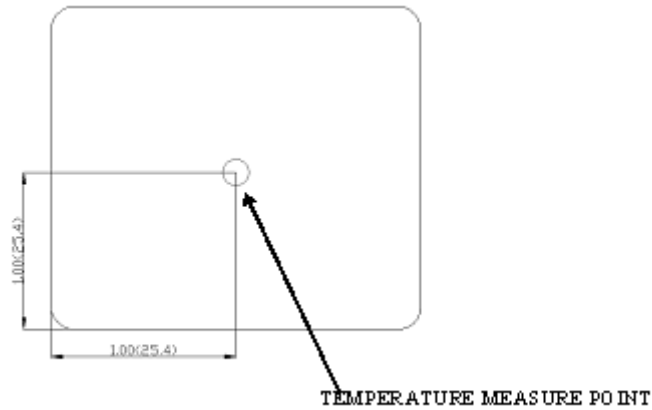

Measurement shown in inches and (millimeters)

TOP VIEW

Heat Sink Consideration

Use heat-sink (7G-0026A) for lowering temperature and higher reliability of the module.

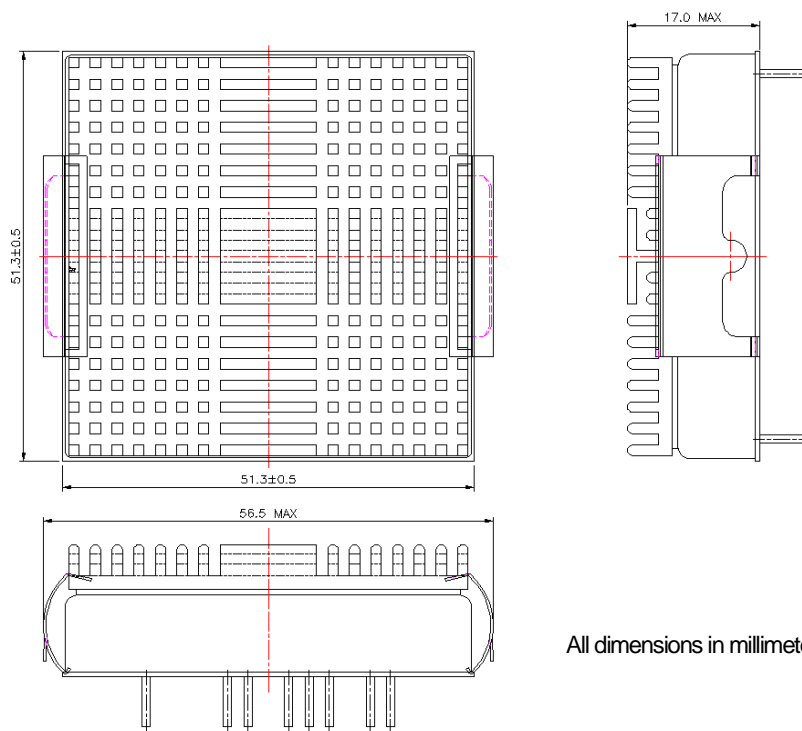

All dimensions in millimeters

Remote ON/OFF Control

The Remote ON/OFF Pin is used to turn on and off the DC/DC converter. The user must use a switch to control the logic voltage (high or low level) of the ON / OFF pin referenced to $V_i (-)$. The switch can be an open collector transistor, FET or Photo-Coupler that is capable of sinking up to 1 mA at low-level logic voltage. At High-level logic(ON/OFF signal maximum voltage): the allowable leakage current of the switch at 12V is 0.5 mA.

Remote ON/OFF Implementation Circuits

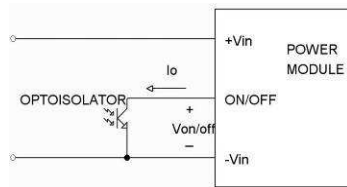

Isolated-Control Remote ON/OFF

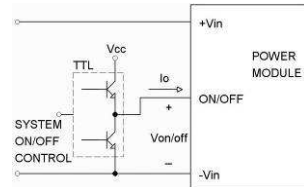

Level Control Using TTL Output

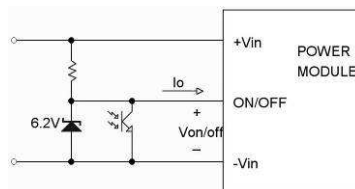

Level Control Using Line Voltage

There are two remote control options available, positive logic and negative logic.

a. Positive Logic:

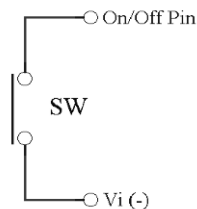

PXF60 module is turned off at Low-level logic

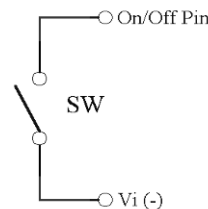

PXF60 module is turned on at High-level logic

b. Negative Logic :

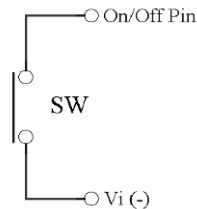

PXF60 module is turned on at Low-level logic

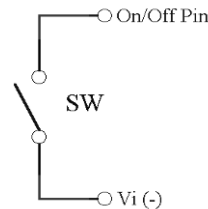

PXF60 module is turned off at High-level logic

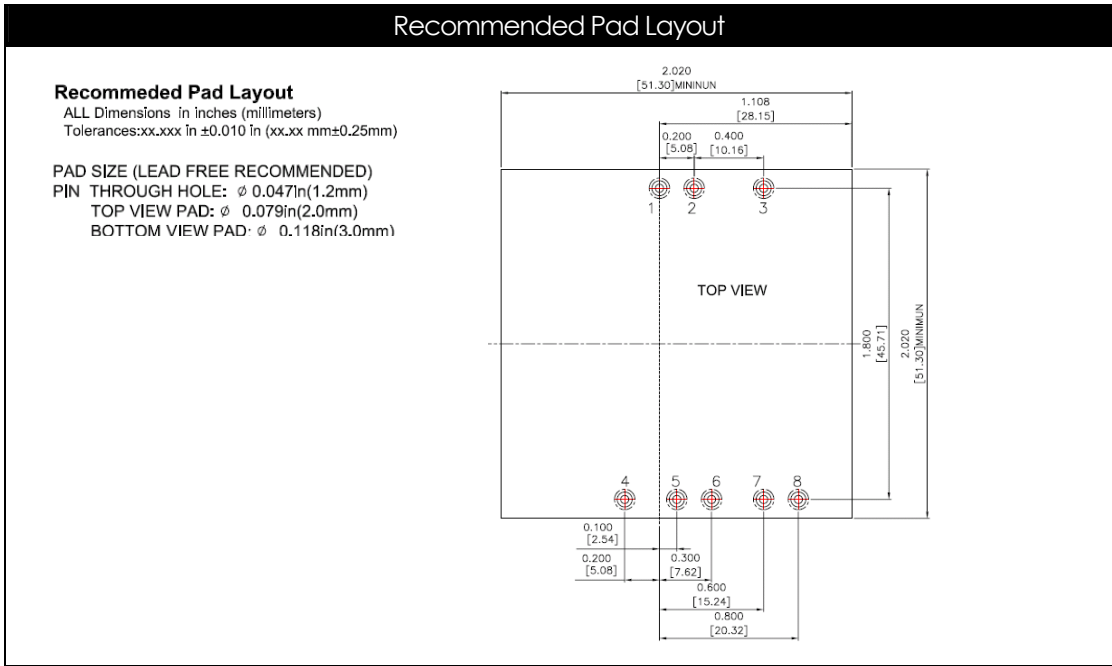
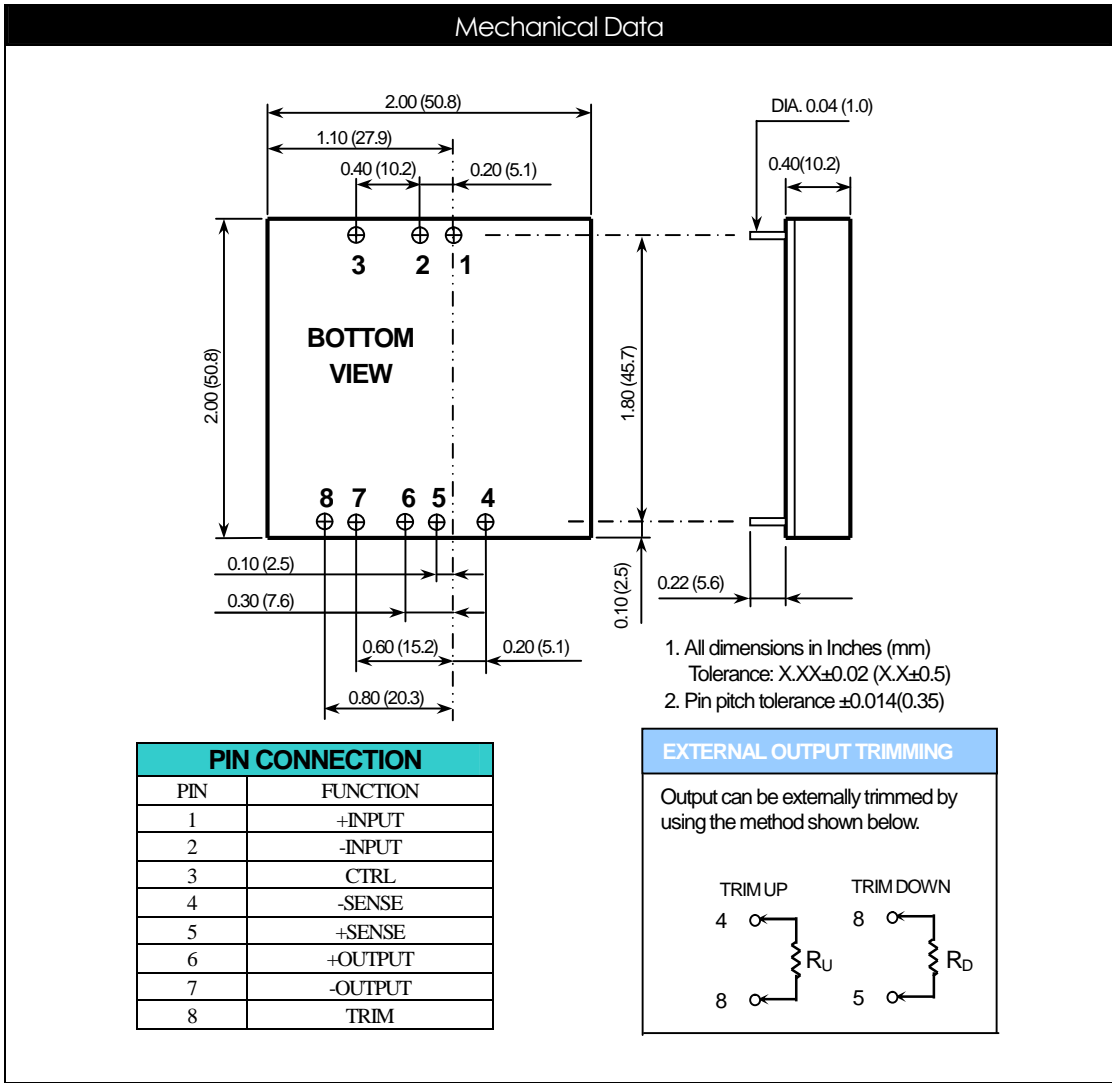

Output Voltage Adjustment

Output voltage set point adjustment allows the user to increase or decrease the output voltage set point of a module. This is accomplished by connecting an external resistor between the TRIM pin and either the SENSE(+) or SENSE(-) pins. With an external resistor between the TRIM and SENSE(-) pin, the output voltage set point increases. With an external resistor between the TRIM and SENSE(+) pin, the output voltage set point decreases.

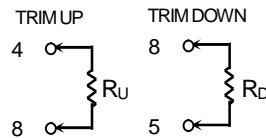

TRIM TABLE

PXF60-xxS3P3

Trim up (%)	1	2	3	4	5	6	7	8	9	10
V _{OUT} (Volts)=	3.333	3.366	3.399	3.432	3.465	3.498	3.531	3.564	3.597	3.630
R _U (K Ohms)=	57.930	26.165	15.577	10.283	7.106	4.988	3.476	2.341	1.459	0.753
Trim down (%)	1	2	3	4	5	6	7	8	9	10
V _{OUT} (Volts)=	3.267	3.234	3.201	3.168	3.135	3.102	3.069	3.036	3.003	2.970
R _D (K Ohms)=	69.470	31.235	18.490	12.117	8.294	5.745	3.924	2.559	1.497	0.647

PXF60-xxS05

Trim up (%)	1	2	3	4	5	6	7	8	9	10
V _{OUT} (Volts)=	5.050	5.100	5.150	5.200	5.250	5.300	5.350	5.400	5.450	5.500
R _U (K Ohms)=	36.570	16.580	9.917	6.585	4.586	3.253	2.302	1.588	1.032	0.588
Trim down (%)	1	2	3	4	5	6	7	8	9	10
V _{OUT} (Volts)=	4.950	4.900	4.850	4.800	4.750	4.700	4.650	4.600	4.550	4.500
R _D (K Ohms)=	45.533	20.612	12.306	8.152	5.660	3.999	2.812	1.922	1.230	0.676

PXF60-xxS12

Trim up (%)	1	2	3	4	5	6	7	8	9	10
V _{OUT} (Volts)=	12.120	12.240	12.360	12.480	12.600	12.720	12.840	12.960	13.080	13.200
R _U (K Ohms)=	367.910	165.950	98.636	64.977	44.782	31.318	21.701	14.488	8.879	4.391
Trim down (%)	1	2	3	4	5	6	7	8	9	10
V _{OUT} (Volts)=	11.880	11.760	11.640	11.520	11.400	11.280	11.160	11.040	10.920	10.800
R _D (K Ohms)=	460.990	207.950	123.600	81.423	56.118	39.249	27.199	18.162	11.132	5.509

PXF60-xxS15

Trim up (%)	1	2	3	4	5	6	7	8	9	10
V _{OUT} (Volts)=	15.150	15.300	15.450	15.600	15.750	15.900	16.050	16.200	16.350	16.500
R _U (K Ohms)=	404.180	180.590	106.060	68.796	46.437	31.531	20.883	12.898	6.687	1.718
Trim down (%)	1	2	3	4	5	6	7	8	9	10
V _{OUT} (Volts)=	14.850	14.700	14.550	14.400	14.250	14.100	13.950	13.800	13.650	13.500
R _D (K Ohms)=	499.820	223.410	131.270	85.204	57.563	39.136	25.974	16.102	8.424	2.282

Remote Sense Application Circuit

The Remote Sense function can be used to regulate the voltage at the load. The Remote Sense voltage range can't be greater than 10% Vo, i.e.:

$$[V_o (+) \text{ to } V_o (-)] - [\text{Sense } (+) \text{ to } \text{Sense } (-)] \leq 10\% V_o$$

If the Remote Sense function is not used,, connect the SENSE (+) to OUTPUT (+) and connect the SENSE (-) to OUTPUT(-) of the PXF60 converter.

RL1 and RL2 are conduction losses

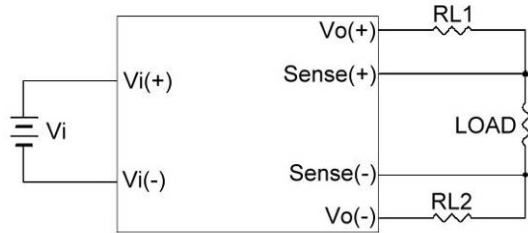

Operation Output Voltage with Sense Function Used

Soldering Considerations

Lead free wave solder profile for PXF60

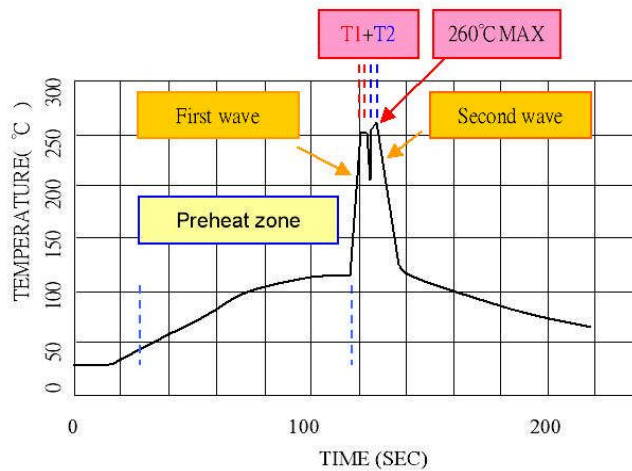

Zone	Reference Parameter
Preheat zone	Rise temp. speed : 3°C / sec max. Preheat temp. : 100~130°C
Actual heating	Peak temp. : 250~260°C Peak time (T1+T2 time) : 4~6 sec

Reference Solder : Sn-Ag-Cu ; Sn-Cu

Hand Welding :

Soldering iron : Power 90W

Welding Time : 2~4 sec

Temp. : 380~400°C

Packaging Information

10 PCS per TUBE

Part Number Structure

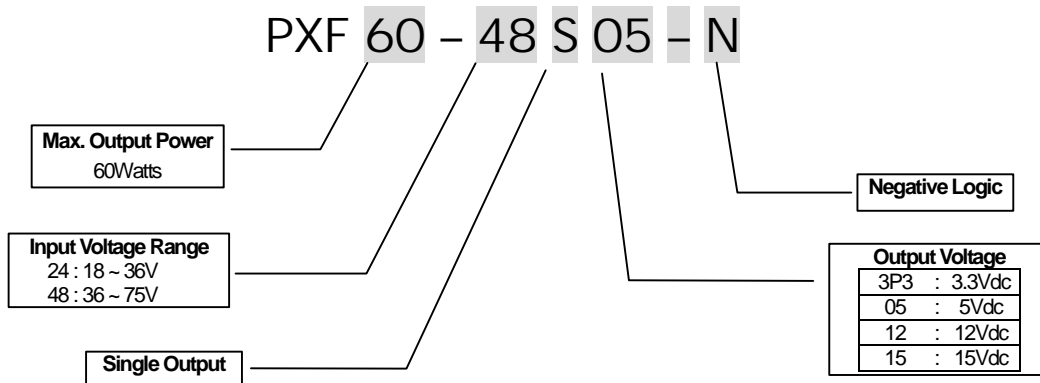

Model Number	Input Range	Output Voltage	Output Current	Input Current	Eff ⁽²⁾ (%)
			Max. Load	Full Load ⁽¹⁾	
PXF60-24S3P3	18 - 36 VDC	3.3 VDC	14000mA	2264mA	89
PXF60-24S05	18 - 36 VDC	5 VDC	12000mA	2941mA	90
PXF60-24S12	18 - 36 VDC	12 VDC	5000mA	2907mA	90
PXF60-24S15	18 - 36 VDC	15 VDC	4000mA	2907mA	90
PXF60-48S3P3	36 - 75 VDC	3.3 VDC	14000mA	1132mA	89
PXF60-48S05	36 - 75 VDC	5 VDC	12000mA	1453mA	90
PXF60-48S12	36 - 75 VDC	12 VDC	5000mA	1453mA	90
PXF60-48S15	36 - 75 VDC	15 VDC	4000mA	1453mA	90

Note 1. Maximum value at nominal input voltage and full load of standard type.

Note 2. Typical value at nominal input voltage and full load.

Safety and Installation Instruction**Fusing Consideration**

Caution: This converter is not internally fused. An input line fuse must always be used.

This converter can be used in a wide variety of applications, ranging from simple stand-alone operation to an integrated part of a sophisticated power architecture. For maximum flexibility, internal fusing is not included; however, to achieve maximum safety and system protection, always use an input line fuse. The safety agencies require a slow-blow fuse with maximum rating of 5A for PXF60-24Sxx modules and 3A for PXF60-48Sxx modules. Based on the information provided in this data sheet on Inrush energy and maximum DC input current; the same type of fuse with lower rating can be used. Refer to the fuse manufacturer's data for further information.

MTBF and Reliability**The MTBF of PXF60-SERIES of DC/DC converters has been calculated using**

Bellcore TR-NWT-000332 Case I: 50% stress, Operating temperature at 40 °C (Ground fixed and controlled environment). The resulting figure for MTBF is 1.093×10^6 hours.

MIL-HDBK-217F NOTICE2 FULL LOAD, Operating temperature at 25°C . The resulting figure for MTBF is 1.096×10^5 hours.