

C3225C0G2A223K160AA

TDK Item Description : C3225C0G2A223KT****



Application & Main Feature

Commercial Grade (Mid Voltage (100 to 630V))

Series

C3225 [EIA CC1210]

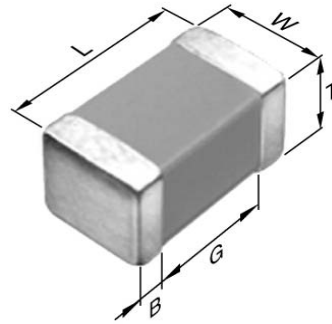

Dimensions

L 3.20mm +/-0.4mm
 W 2.50mm +/-0.3mm
 T 1.60mm +/-0.2mm
 B 0.20mm Min.
 G

Temperature Characteristic

C0G (-55 to 125 degC 0+/-30ppm/degC)

Rated Voltage

2A (100Vdc)

Capacitance

22nF

Capacitance Tolerance

K (+/-10%)

Q Factor

1000 Min.

Insulation Resistance

10Gohm Min.

AEC-Q200

Not Applicable

|Z|, ESR vs. Freq. Characteristics

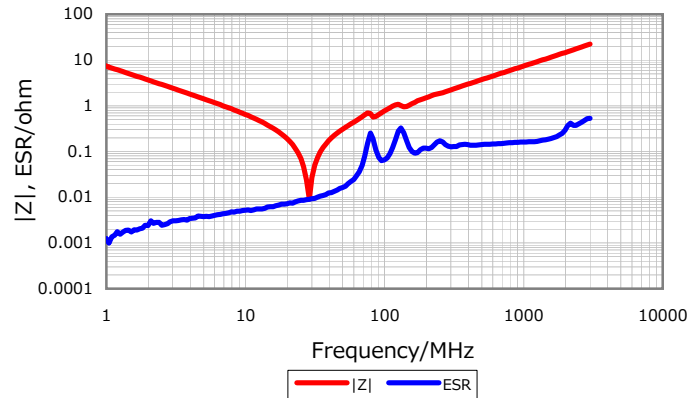

DC Bias Characteristic



Cap. vs. Freq. Characteristic

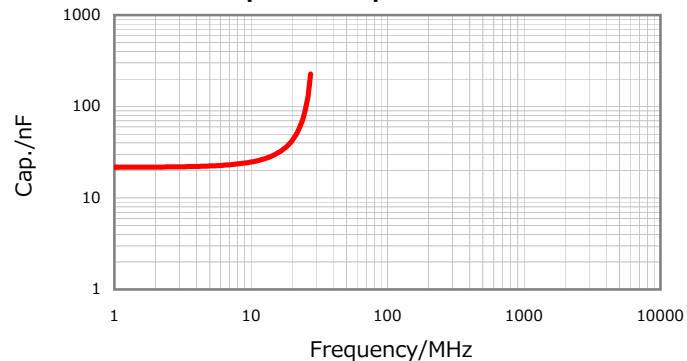

Temperature Characteristics



Characterization Sheet (Multilayer Ceramic Chip Capacitors)



All specifications are subject to change without notice.

January 4, 2016