

50 Ω nominal input / conjugate match balun CC2610, CC2620, CC2630, CC2640, CC2650 MHz, with integrated harmonic filter

Datasheet - production data

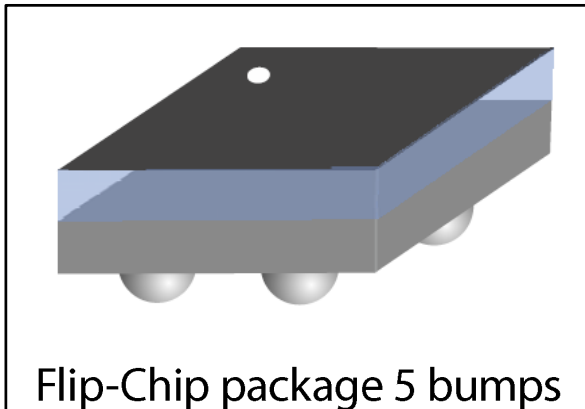

Description

STMicroelectronics' BALF-CC26-05D3 is an ultra-miniature balun, integrating both matching network and harmonics filter.

Matching impedance has been customized for the TI CC26xx series 5x5 SimpleLink™ multistandard wireless MCU.

The device uses STMicroelectronics' IPD technology on a non-conductive glass substrate, which optimizes RF performance.

Features

- 2.45 GHz balun with integrated matching network
- Matching optimized for CC26 series 5x5 external differential
- Low insertion loss
- Low amplitude imbalance
- Low phase imbalance
- Coated Flip-Chip on glass
- Small footprint < 1.5 mm²

Benefits

- Very low profile
- High RF performance
- PCB space saving versus discrete solution
- RF BOM and size reduction
- Efficient manufacturability

Figure 1: Pin configuration

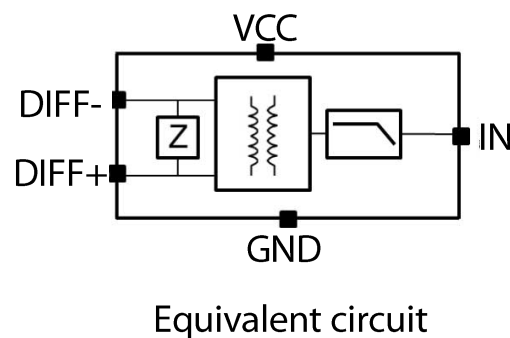
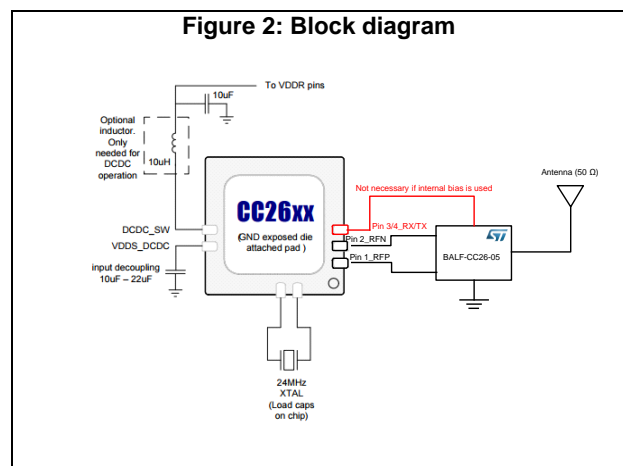

Figure 2: Block diagram



1 Characteristics

Table 1: Absolute maximum ratings (limiting values)

Symbol	Parameter	Value	Unit
P _{IN}	Input power RFIN	20	dBm
V _{ESD}	ESD ratings MIL STD883C (HBM: C = 100 pF, R = 1.5 Ω, air discharge)	900	V
	ESD ratings machine model (MM: C = 200 pF, R = 25 W, L = 500 nH)	100	
T _{OP}	Operating temperature	-40 to +105	°C

Table 2: Electrical characteristics (T_{amb} = 25 °C)

Symbol	Parameter	Value			Unit
		Min.	Typ.	Max.	
Z _{OUT}	Nominal differential output impedance	Match to 5x5 CC26xx series			Ω
Z _{IN}	Nominal input impedance		50		Ω
f	Frequency range (bandwidth)	2400		2500	MHz
IL	Insertion loss in bandwidth		1.2	1.5	dB
RL SE	Single Ended Return loss in bandwidth		-27	-18	dB
RL DIFF	Differential Return loss in bandwidth		-23	-20	dB
Phase_imbal	Phase imbalance	-16		16	°
Ampl_imbal	Amplitude imbalance	-0.3		0.3	dB
H2	Second harmonic rejection		-18	-17	
H3	Third harmonic rejection		-37	-35	

1.2 RF measurement

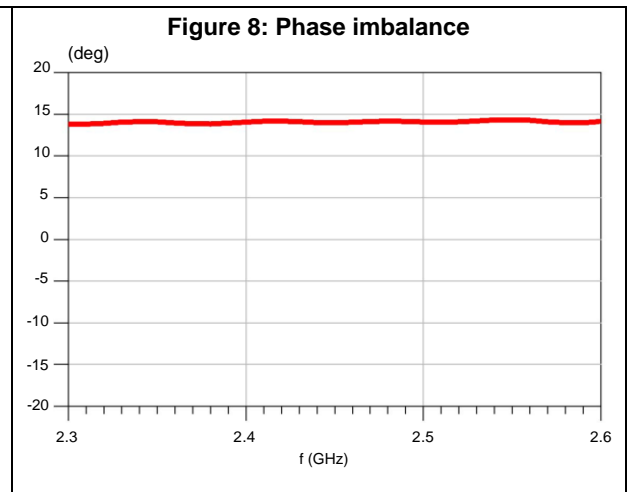
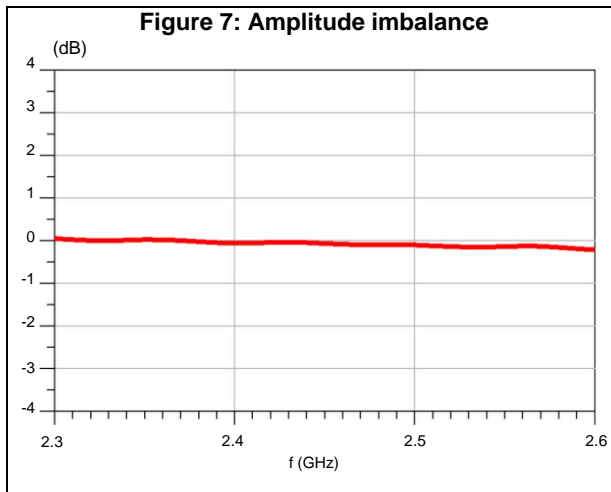
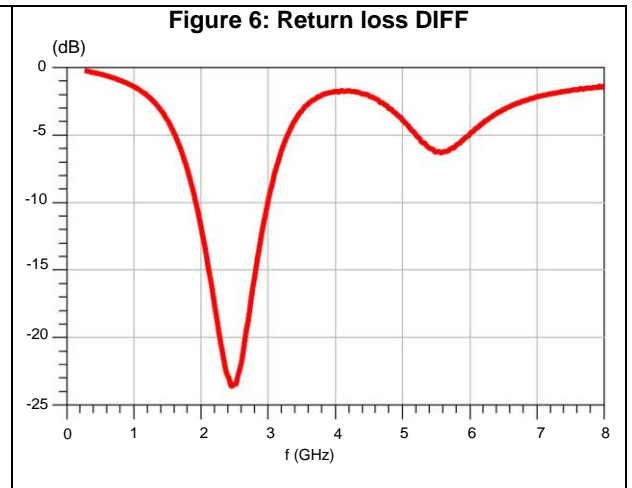
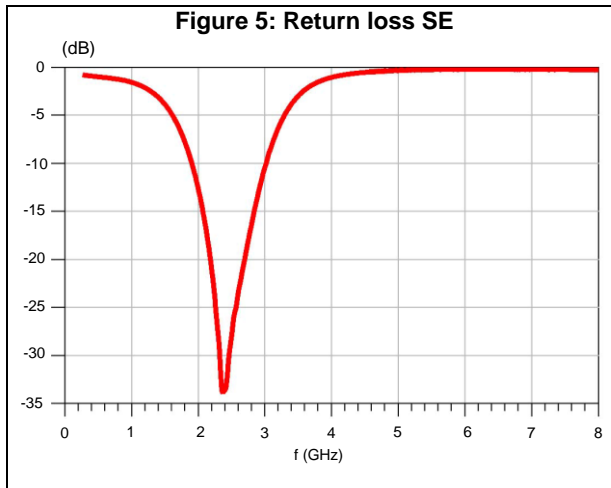
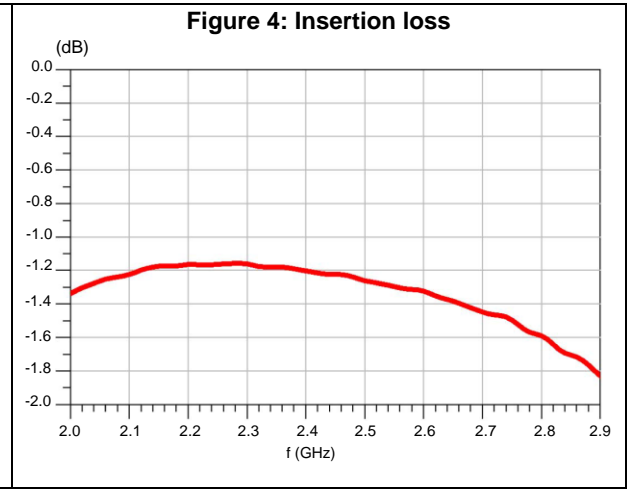
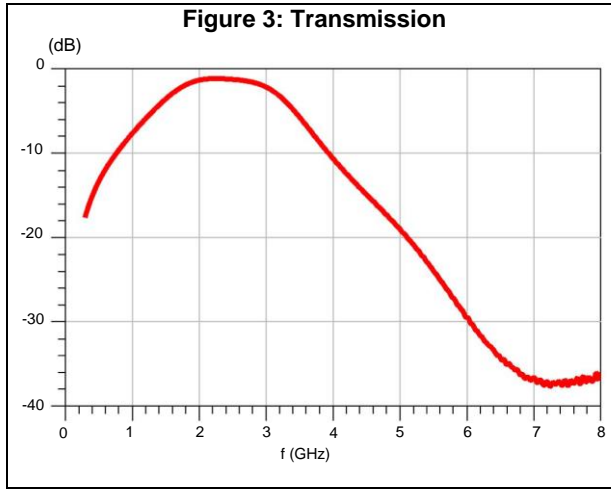

2 Package information

In order to meet environmental requirements, ST offers these devices in different grades of ECOPACK® packages, depending on their level of environmental compliance. ECOPACK® specifications, grade definitions and product status are available at: www.st.com. ECOPACK® is an ST trademark.

2.1 Flip-Chip CSPG 0.4 package information

Figure 9: Flip-Chip CSPG 0.4 package outline

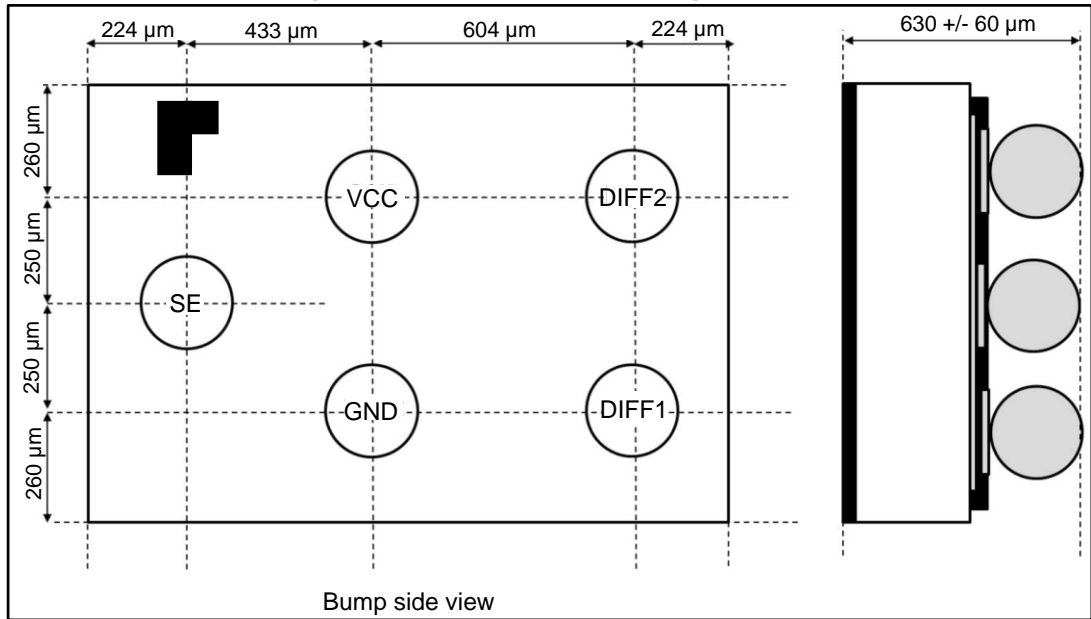

Bump side view

Figure 10: PCB layout recommendation

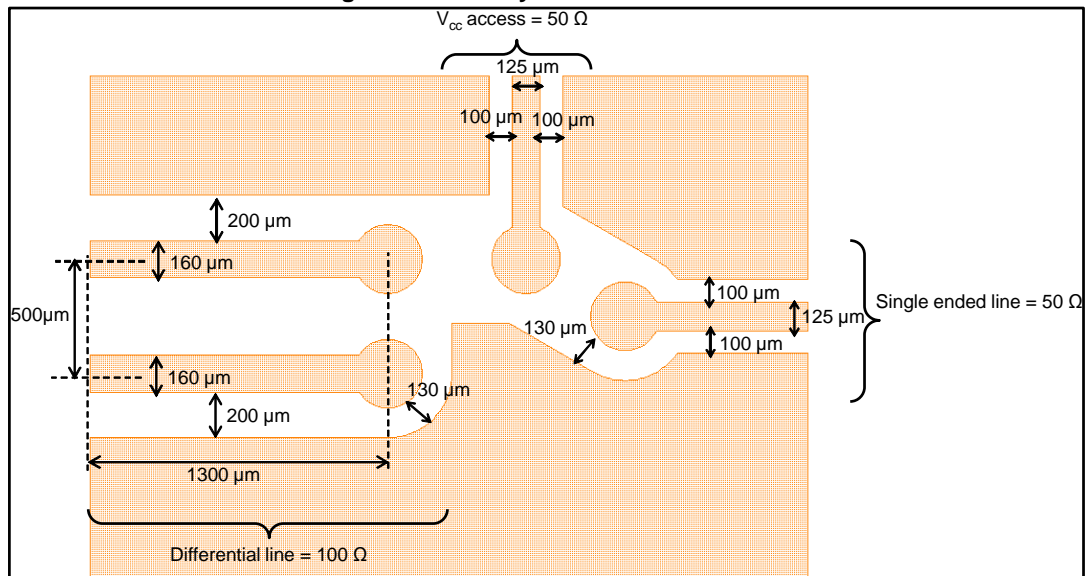

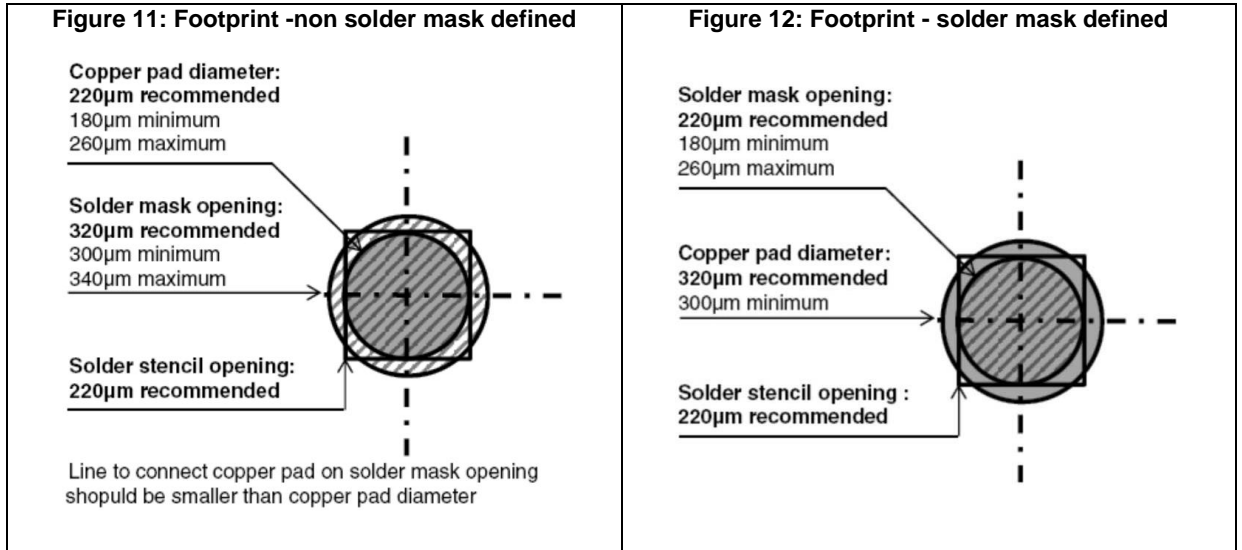

2.2 Flip-chip CSPG 0.4 packing information

Figure 13: Flip-chip CSPG 0.4 tape outline

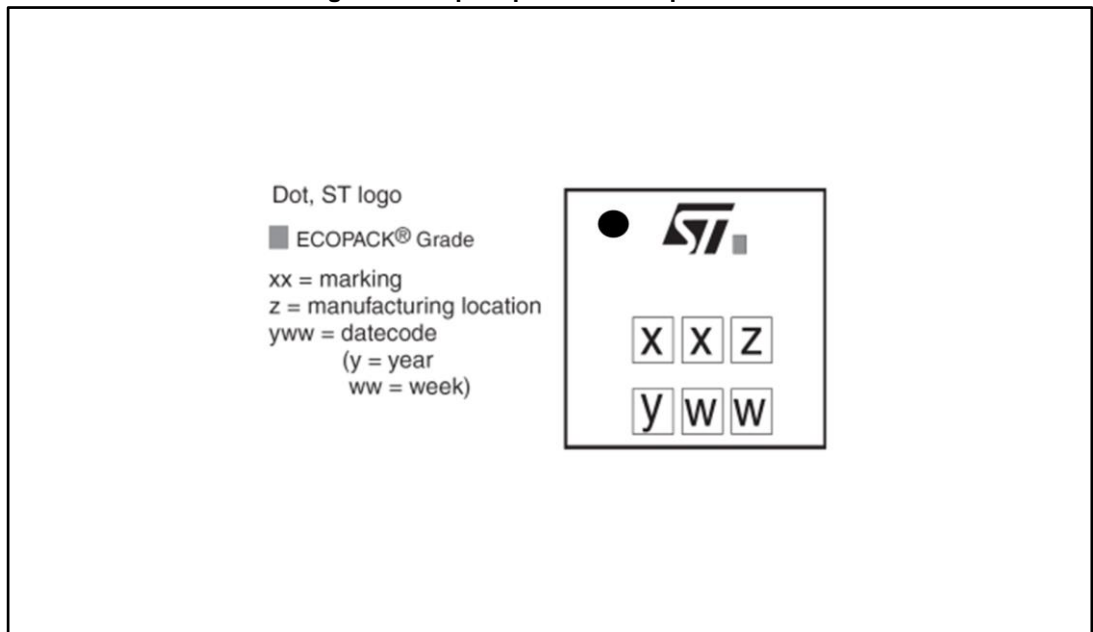
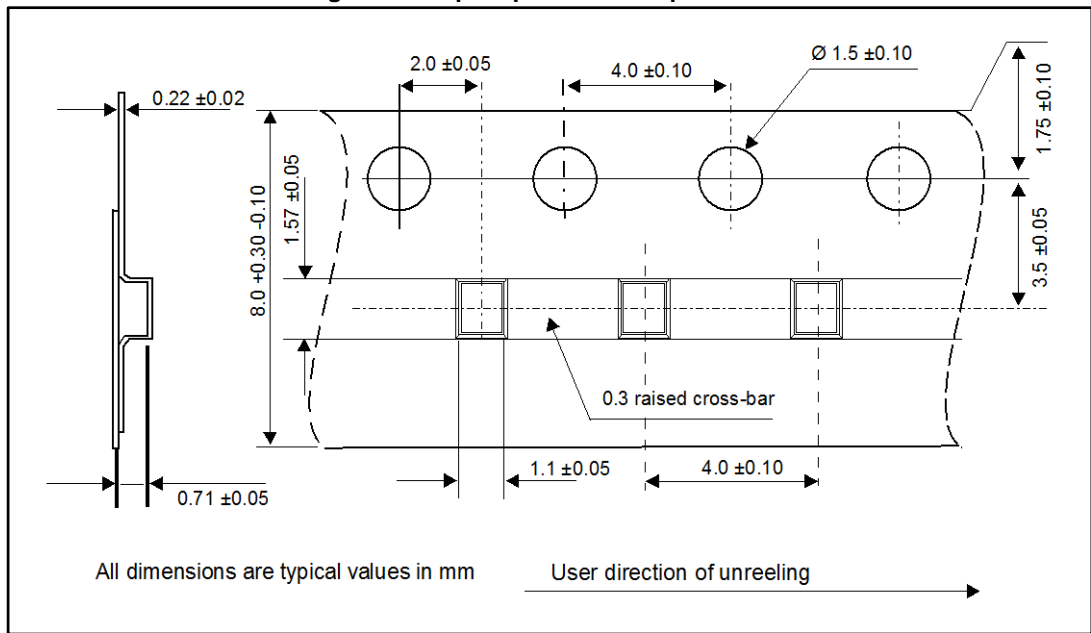

Figure 14: Flip-chip CSPG 0.4 tape outline



3 Ordering information

Table 3: Ordering information

Order code	Marking	Package	Weight	Base qty.	Delivery mode
BALF-CC26-05D3	TH	Flip-Chip CSPG 0.4	1.724 mg	5000	Tape and reel (7")

4 Revision history

Table 4: Document revision history

Date	Revision	Changes
27-Jul-2016	1	First issue.

IMPORTANT NOTICE – PLEASE READ CAREFULLY

STMicroelectronics NV and its subsidiaries ("ST") reserve the right to make changes, corrections, enhancements, modifications, and improvements to ST products and/or to this document at any time without notice. Purchasers should obtain the latest relevant information on ST products before placing orders. ST products are sold pursuant to ST's terms and conditions of sale in place at the time of order acknowledgement.

Purchasers are solely responsible for the choice, selection, and use of ST products and ST assumes no liability for application assistance or the design of Purchasers' products.

No license, express or implied, to any intellectual property right is granted by ST herein.

Resale of ST products with provisions different from the information set forth herein shall void any warranty granted by ST for such product.

ST and the ST logo are trademarks of ST. All other product or service names are the property of their respective owners.

Information in this document supersedes and replaces information previously supplied in any prior versions of this document.

© 2016 STMicroelectronics – All rights reserved