



**14-Pin SOIC/DIP/TSSOP  
Evaluation Board  
User's Guide**

---

**Note the following details of the code protection feature on Microchip devices:**

- Microchip products meet the specification contained in their particular Microchip Data Sheet.
- Microchip believes that its family of products is one of the most secure families of its kind on the market today, when used in the intended manner and under normal conditions.
- There are dishonest and possibly illegal methods used to breach the code protection feature. All of these methods, to our knowledge, require using the Microchip products in a manner outside the operating specifications contained in Microchip's Data Sheets. Most likely, the person doing so is engaged in theft of intellectual property.
- Microchip is willing to work with the customer who is concerned about the integrity of their code.
- Neither Microchip nor any other semiconductor manufacturer can guarantee the security of their code. Code protection does not mean that we are guaranteeing the product as "unbreakable."

Code protection is constantly evolving. We at Microchip are committed to continuously improving the code protection features of our products. Attempts to break Microchip's code protection feature may be a violation of the Digital Millennium Copyright Act. If such acts allow unauthorized access to your software or other copyrighted work, you may have a right to sue for relief under that Act.

---

Information contained in this publication regarding device applications and the like is provided only for your convenience and may be superseded by updates. It is your responsibility to ensure that your application meets with your specifications. MICROCHIP MAKES NO REPRESENTATIONS OR WARRANTIES OF ANY KIND WHETHER EXPRESS OR IMPLIED, WRITTEN OR ORAL, STATUTORY OR OTHERWISE, RELATED TO THE INFORMATION, INCLUDING BUT NOT LIMITED TO ITS CONDITION, QUALITY, PERFORMANCE, MERCHANTABILITY OR FITNESS FOR PURPOSE. Microchip disclaims all liability arising from this information and its use. Use of Microchip devices in life support and/or safety applications is entirely at the buyer's risk, and the buyer agrees to defend, indemnify and hold harmless Microchip from any and all damages, claims, suits, or expenses resulting from such use. No licenses are conveyed, implicitly or otherwise, under any Microchip intellectual property rights.

**Trademarks**

The Microchip name and logo, the Microchip logo, Accuron, dsPIC, KEELOQ, microID, MPLAB, PIC, PICmicro, PICSTART, PRO MATE, PowerSmart, rPIC and SmartShunt are registered trademarks of Microchip Technology Incorporated in the U.S.A. and other countries.

AmpLab, FilterLab, Migratable Memory, MXDEV, MXLAB, PICMASTER, SEEVAL, SmartSensor and The Embedded Control Solutions Company are registered trademarks of Microchip Technology Incorporated in the U.S.A.

Analog-for-the-Digital Age, Application Maestro, dsPICDEM, dsPICDEM.net, dsPICworks, ECAN, ECONOMONITOR, FanSense, FlexROM, fuzzyLAB, In-Circuit Serial Programming, ICSP, ICEPIC, Linear Active Thermistor, MPASM, MPLIB, MPLINK, MPSIM, PICKit, PICDEM, PICDEM.net, PICLAB, PICTail, PowerCal, PowerInfo, PowerMate, PowerTool, Real ICE, rLAB, rPICDEM, Select Mode, Smart Serial, SmartTel, Total Endurance, UNI/O, WiperLock and Zena are trademarks of Microchip Technology Incorporated in the U.S.A. and other countries.

SQTP is a service mark of Microchip Technology Incorporated in the U.S.A.

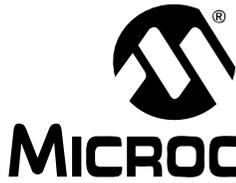
All other trademarks mentioned herein are property of their respective companies.

© 2006, Microchip Technology Incorporated, Printed in the U.S.A., All Rights Reserved.

 Printed on recycled paper.

**QUALITY MANAGEMENT SYSTEM**  
**CERTIFIED BY DNV**  
**== ISO/TS 16949:2002 ==**

*Microchip received ISO/TS-16949:2002 quality system certification for its worldwide headquarters, design and wafer fabrication facilities in Chandler and Tempe, Arizona and Mountain View, California in October 2003. The Company's quality system processes and procedures are for its PICmicro® 8-bit MCUs, KEELOQ® code hopping devices, Serial EEPROMs, microperipherals, nonvolatile memory and analog products. In addition, Microchip's quality system for the design and manufacture of development systems is ISO 9001:2000 certified.*



# 14-PIN SOIC/DIP/TSSOP EVALUATION BOARD USER'S GUIDE

---

---

## Table of Contents

---

---

<b>Preface</b> .....	<b>1</b>
<b>Chapter 1. Product Overview</b> .....	<b>5</b>
1.1 Introduction .....	5
1.2 What is the 14-Pin SOIC/DIP/TSSOP Evaluation Board? .....	5
1.3 What the 14-Pin SOIC/DIP/TSSOP Evaluation Board Kit Includes .....	5
<b>Chapter 2. Installation and Operation</b> .....	<b>7</b>
2.1 Introduction .....	7
2.2 Features .....	7
2.3 Getting Started .....	8
2.4 14-Pin SOIC/DIP/TSSOP Evaluation Board Description .....	13
<b>Appendix A. Schematic and Layouts</b> .....	<b>17</b>
A.1 Introduction .....	17
A.2 Schematics and PCB Layout .....	17
<b>Appendix B. Bill Of Materials (BOM)</b> .....	<b>27</b>
<b>Appendix C. Microchip Analog and Interface Device Compatibility</b> .....	<b>29</b>
C.1 Introduction .....	29
<b>Worldwide Sales and Service</b> .....	<b>32</b>

# 14-Pin SOIC/DIP/TSSOP Evaluation Board User's Guide

---

---

NOTES:



**MICROCHIP**

# 14-PIN SOIC/DIP/TSSOP EVALUATION BOARD USER'S GUIDE

## Preface

### NOTICE TO CUSTOMERS

All documentation becomes dated, and this manual is no exception. Microchip tools and documentation are constantly evolving to meet customer needs, so some actual dialogs and/or tool descriptions may differ from those in this document. Please refer to our web site ([www.microchip.com](http://www.microchip.com)) to obtain the latest documentation available.

Documents are identified with a “DS” number. This number is located on the bottom of each page, in front of the page number. The numbering convention for the DS number is “DSXXXXA”, where “XXXX” is the document number and “A” is the revision level of the document.

### INTRODUCTION

This chapter contains general information that will be useful to know before using the 14-Pin SOIC/DIP/TSSOP Evaluation Board. Items discussed in this chapter include:

- Document Layout
- Conventions Used in this Guide
- Recommended Reading
- The Microchip Web Site
- Customer Support
- Document Revision History

### DOCUMENT LAYOUT

This document describes how to use the 14-Pin SOIC/DIP/TSSOP Evaluation Board. The manual layout is as follows:

- **Chapter 1. “Product Overview”** – Important information about the 14-Pin SOIC/DIP/TSSOP Evaluation Board.
- **Chapter 2. “Installation and Operation”** – Includes instructions on how to get started with this evaluation board.
- **Appendix A. “Schematic and Layouts”** – Shows the schematic and layout diagrams for the 14-Pin SOIC/DIP/TSSOP Evaluation Board.
- **Appendix B. “Bill Of Materials (BOM)”** – Lists the parts that can be installed onto the 14-Pin SOIC/DIP/TSSOP Evaluation Board.
- **Appendix C. “Microchip Analog and Interface Device Compatibility”** – Documents the Microchip Analog & Interface devices that are footprint compatible with this PCB.

# 14-Pin SOIC/DIP/TSSOP Evaluation Board User's Guide

---

## CONVENTIONS USED IN THIS GUIDE

This manual uses the following documentation conventions:

### DOCUMENTATION CONVENTIONS

Description	Represents	Examples
<b>Arial font:</b>		
Italic characters	Referenced books	<i>MPLAB<sup>®</sup> IDE User's Guide</i>
	Emphasized text	...is the <i>only</i> compiler...

## RECOMMENDED READING

This blank PCB is generic and can be used with any Microchip device that is offered in one of the following 14-pin packages:

- SOIC
- DIP
- TSSOP

For more information regarding devices available in these 14-pin packages, please refer to the Microchip web site at [www.microchip.com](http://www.microchip.com).

## THE MICROCHIP WEB SITE

Microchip provides online support via our web site at [www.microchip.com](http://www.microchip.com). This web site is used as a means to make files and information easily available to customers. Accessible by using your favorite Internet browser, the web site contains the following information:

- **Product Support** – Data sheets and errata, application notes and sample programs, design resources, user's guides and hardware support documents, latest software releases and archived software
- **General Technical Support** – Frequently Asked Questions (FAQs), technical support requests, online discussion groups, Microchip consultant program member listing
- **Business of Microchip** – Product selector and ordering guides, latest Microchip press releases, listing of seminars and events, listings of Microchip sales offices, distributors and factory representatives

## CUSTOMER SUPPORT

Users of Microchip products can receive assistance through several channels:

- Distributor or Representative
- Local Sales Office
- Field Application Engineer (FAE)
- Technical Support
- Development Systems Information Line

Customers should contact their distributor, representative or field application engineer (FAE) for support. Local sales offices are also available to help customers. A listing of sales offices and locations is included in the back of this document.

Technical support is available through the web site at: <http://support.microchip.com>

## DOCUMENT REVISION HISTORY

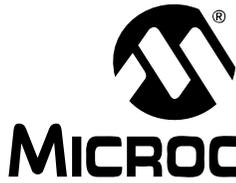
### Revision A (January 2006)

- Initial Release of this Document.

# 14-Pin SOIC/DIP/TSSOP Evaluation Board User's Guide

---

NOTES:



# 14-PIN SOIC/DIP/TSSOP EVALUATION BOARD USER'S GUIDE

---

---

## Chapter 1. Product Overview

---

---

### 1.1 INTRODUCTION

This chapter provides an overview of the 14-Pin SOIC/DIP/TSSOP Evaluation Board and covers the following topics:

- What is the 14-Pin SOIC/DIP/TSSOP Evaluation Board?
- What the 14-Pin SOIC/DIP/TSSOP Evaluation Board kit includes

### 1.2 WHAT IS THE 14-PIN SOIC/DIP/TSSOP EVALUATION BOARD?

The 14-Pin SOIC/DIP/TSSOP Evaluation Board allows the system designer to quickly evaluate the operation of Microchip Technology's devices in any of the following 14-pin packages:

- SOIC
- DIP
- TSSOP

Some of the Microchip's family of devices that can be evaluated in the PCB include:

- A/D Converters (ADCs)
- Battery Chargers
- Comparators
- D/A Converters (DACs)
- DC-to-DC Converters
- Digital Potentiometers (Digi-Pots)
- Fan Controllers
- Integrated Devices
- Interface Devices
- Linear Regulators
- Operational Amplifiers (Op Amps)
- Power MOSFET Drivers
- Programmable Gain Amplifiers (PGAs)
- Switching Regulators
- Temperature Sensors
- Voltage Supervisors and Voltage Detectors
- PICmicro<sup>®</sup> Microcontrollers

### 1.3 WHAT THE 14-PIN SOIC/DIP/TSSOP EVALUATION BOARD KIT INCLUDES

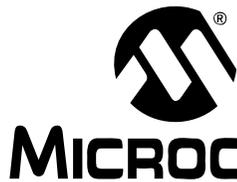
This 14-Pin SOIC/DIP/TSSOP Evaluation Board Kit includes:

- Five 14-Pin SOIC/DIP/TSSOP Evaluation Board Printed Circuit Boards (PCBs)
- 14-Pin SOIC/DIP/TSSOP Evaluation Board User's Guide (Electronic version on CD)

# 14-Pin SOIC/DIP/TSSOP Evaluation Board User's Guide

---

NOTES:



# 14-PIN SOIC/DIP/TSSOP EVALUATION BOARD USER'S GUIDE

---

---

## Chapter 2. Installation and Operation

---

---

### 2.1 INTRODUCTION

This blank Printed Circuit Board allows any 14-pin device in the following four package types to be installed:

1. SOIC-14
2. PDIP-14
3. TSSOP-14

This board is generic so that any device may be installed. Refer to the device data sheet, however, for suitability of device evaluation.

As well as the device, other desired passive components (resistors and capacitors) and connection posts may be installed. This allows the board to evaluate a minimum configuration for the device. Also, this allows the device to easily be jumpered into an existing system.

### 2.2 FEATURES

The 14-Pin SOIC/DIP/TSSOP Evaluation Board has the following features:

- Connection terminals may be either through-hole or surface-mount
- Three 14-pin package footprints supported:
  - SOIC
  - DIP
  - TSSOP
- Footprints for optional passive components and other devices for:
  - Power supply filtering
  - Device bypass capacitor
  - Output filtering
  - Output pull-up resistor
  - Output pull-down resistor
  - Output loading resistor
  - Output series resistor
  - Up to four additional passive components
  - Jumper Headers
  - SOT-23-6
- Silk-screen area to write specifics of implemented circuit (on back of PCB), such as MCP2120 (to indicate that the device is MCP2120)
- PICmicro<sup>®</sup> MCU Baseline Flash Microcontroller Programmer (BFMP) Header
- Can be used for SOIC-14, TSSOP-14 to DIP-14 converter

# 14-Pin SOIC/DIP/TSSOP Evaluation Board User's Guide

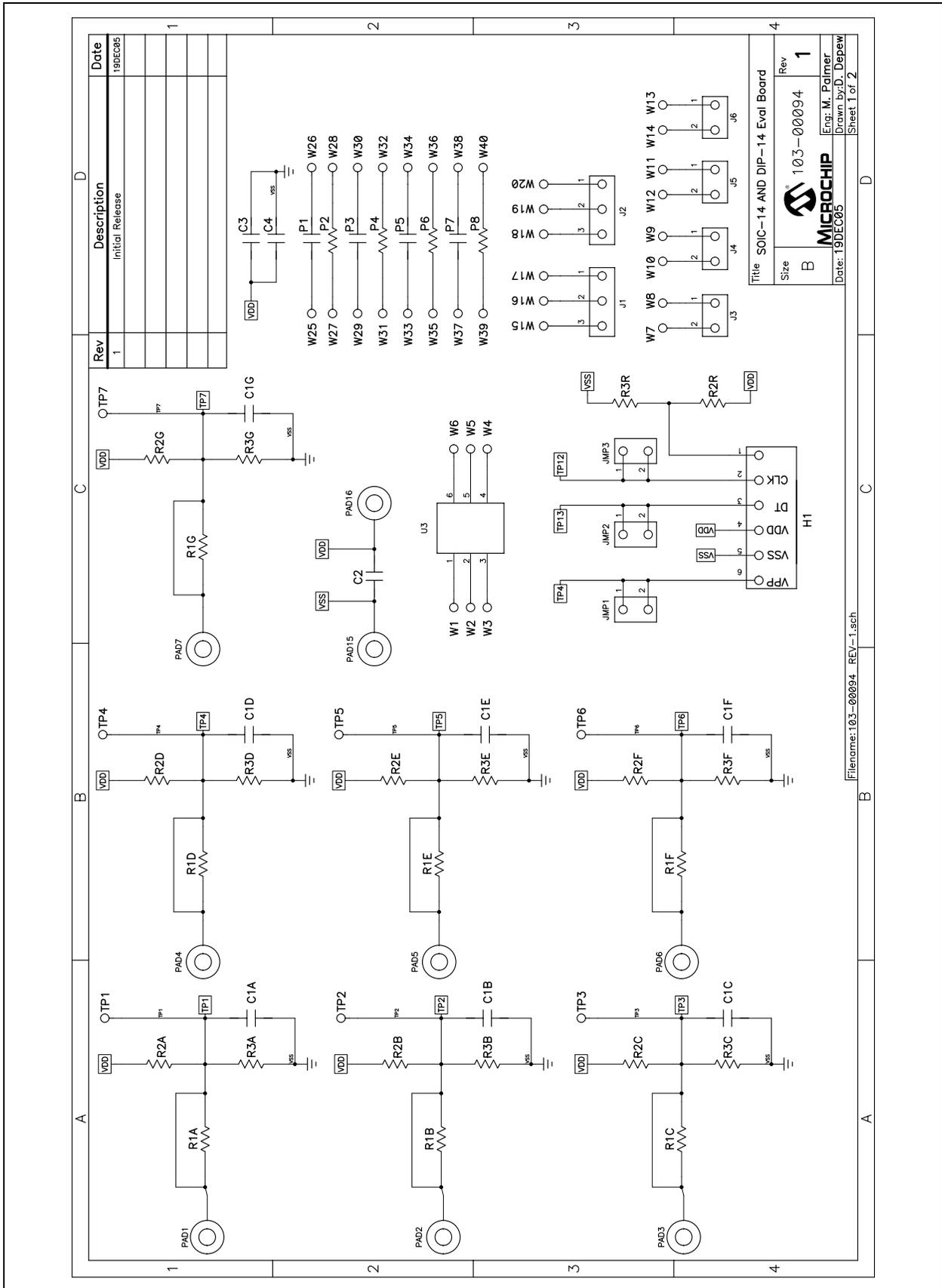
---

## 2.3 GETTING STARTED

The 14-Pin SOIC/DIP/TSSOP Evaluation Board is a blank PCB that allows the user to configure the circuit to the exact requirements. The passive components use the surface-mount 805 package layout.

Figure 2-1 shows the evaluation board circuit. Pin “n” of each device (U1, U2 and U4) is tied together. These pins are then connected with pad “n” of the PCB (through a circuit). This circuit allows each pin to individually have any of the following: a pull-up resistor, a pull-down resistor, an in-line resistor and/or a loading/filtering capacitor. Device-filtering capacitors are available (C2 and C3), as well as a power supply filtering capacitor (C1).

There may be cases where some additional passive components are desired for the evaluation circuit. The PCB has four 805 footprints that are not connected (labeled P1, P2, P3 and P4) and can easily be jumpered into the desired circuit.



**FIGURE 2-1:** 14-Pin SOIC/DIP/TSSOP Evaluation Board Circuit (Page 1).

# 14-Pin SOIC/DIP/TSSOP Evaluation Board User's Guide

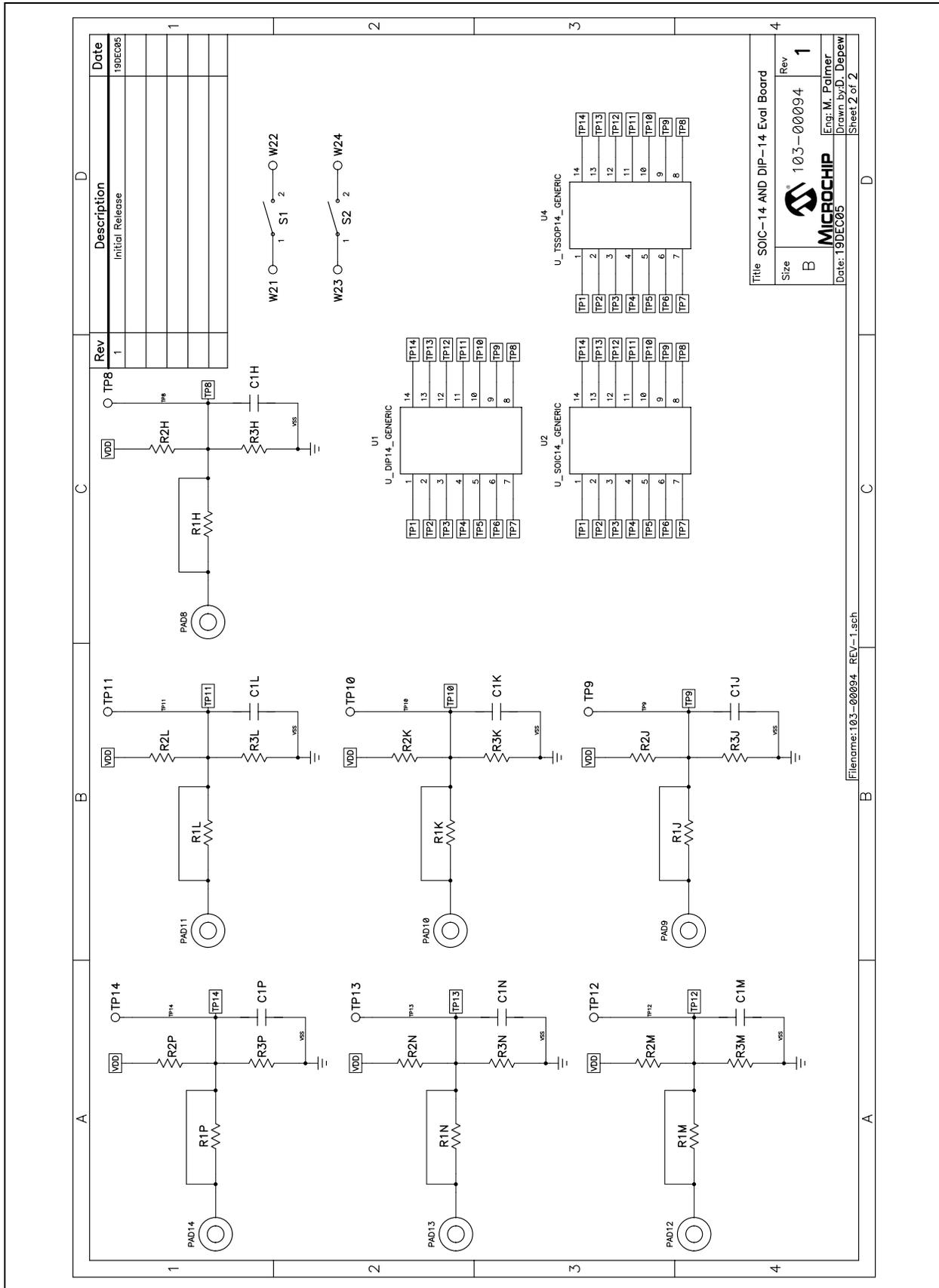


FIGURE 2-2: 14-Pin SOIC/DIP/TSSOP Evaluation Board Circuit (Page 2)

## 2.3.1 The Hardware

Figure 2-3 shows the layout of the 14-Pin SOIC/DIP/TSSOP Evaluation Board. This is a small four-layer board (3.55" x 1.79" (9.02 mm x 4.55 mm)). There are sixteen connection points/pads that can use either through-hole or surface-mount connector posts.

The pad labeled VDD is connected to the PCB power plane, while the pad labeled VSS is connected to the PCB ground plane. All the passive components that are connected to VDD or VSS are connected to either the power plane or ground plane.

The fourteen remaining PCB pads correspond to the device pins (i.e.; pad 1 connects to pin 1).

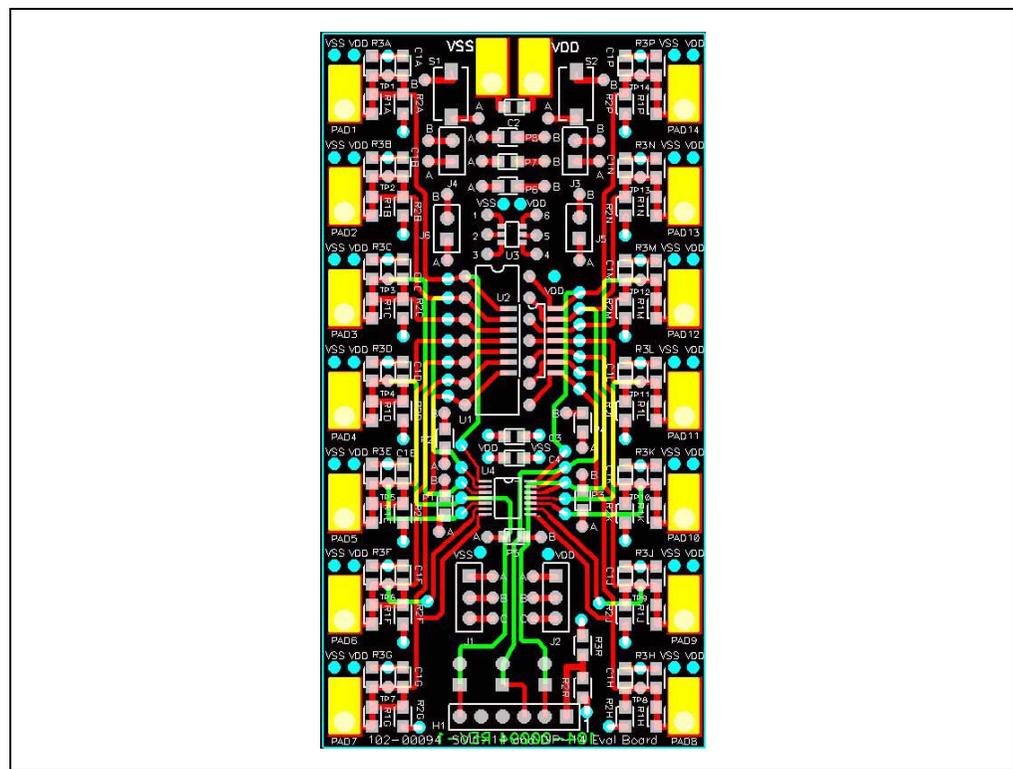
Each pad has four passive components associated with them: a pull-up resistor (R2x), a pull-down resistor (R3x), an in-line resistor (R1x) and a filtering/load capacitor (C1x). The "x" is an alpha character that corresponds to a particular pad (A to P). As an example, Pad 5's pull-up resistor is R2E.

The green area of Figure 2-3 shows the silk-screen on the bottom layer of the PCB. This is where the details of the implemented circuit can be written.

Capacitor C1 is the power supply filtering capacitor.

Capacitors C2 and C3 are bypass capacitors that may be required to be installed, depending on the device selected and the system requirements (such as the noise present on the power supply). Table 2-1 describes the components.

A 6-pin header interface is available that supports the PICmicro MCU Baseline Flash Microcontroller Programmer (BFMP) interface. For additional information, refer to **Section 2.4.5 "Baseline Flash Microcontroller Programmer (BFMP) Interface (Header J1)"**.



**FIGURE 2-3:** 14-Pin SOIC/DIP/TSSOP Evaluation Board Layout.

# 14-Pin SOIC/DIP/TSSOP Evaluation Board User's Guide

---

**TABLE 2-1: OPTIONAL PASSIVE COMPONENTS**

Device	Comment
C2	Power supply bypass capacitor
C3, C4	Device filtering capacitor
C1A, C1B, C1C, C1D, C1E, C1F, C1G, C1H, C1J, C1K, C1L, C1M, C1N, C1P	Output filter capacitor
R1A, R1B, R1C, R1D, R1E, R1F, R1G, R1H, R1J, R1K, R1L, R1M, R1N, R1P	In-line resistance of device output
R2A, R2B, R2C, R2D, R2E, R2F, R2G, R2H, R2J, R2K, R2L, R2M, R2N, R2P	Pull-up resistor
R3A, R3B, R3C, R3D, R3E, R3F, R3G, R3H, R3J, R3K, R3L, R3M, R3N, R3P	Pull-down resistor
P1, P2, P3, P4, P5, P6, P7, P8	Optional passive components
U1	14-pin DIP footprint
U2	14-pin SOIC footprint
U3	6-pin SOT-23 footprint
U4	14-pin TSSOP footprint
H1	BFMP Header Interface
J1, J2	3-pin Header for jumper connections
J3, J4, J5, J6	2-pin Header for jumper connections
S1, S2	Switch footprint

## 2.4 14-PIN SOIC/DIP/TSSOP EVALUATION BOARD DESCRIPTION

The 14-Pin SOIC/DIP/TSSOP Evaluation Board PCB is designed to be flexible in the type of device evaluation that can be implemented.

The following sections describe each element of this evaluation board in further detail. Refer to Figure 2-4.

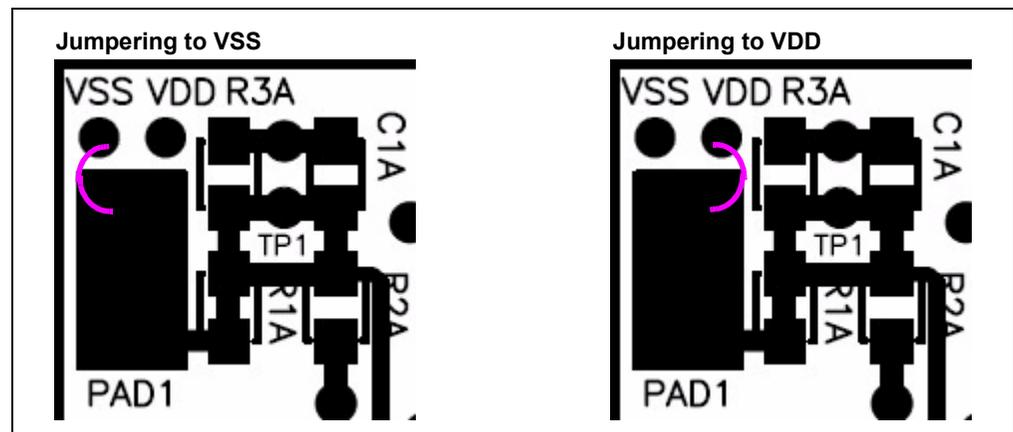
### 2.4.1 Power and Ground

The 14-Pin SOIC/DIP/TSSOP Evaluation Board has a VDD pad and a VSS pad. These pads can have connection posts installed that allow easy connection to the power (VDD) and ground (VSS) planes. The layout allows either through-hole or surface-mount connectors.

The power and ground planes are connected to the appropriate passive components on the PCB (such as power plane to R2X and ground plane to R3X and C1X).

### 2.4.2 PCB PADS

For each package pin (pins 1 to 14), there is a PCB pad (pads 1 to 14). The device will have some power pins (VDD) and some ground pins (VSS). To ease connections on the PCB, vias to the power and ground plane have been installed close to each PCB pad. This allows any pad to be connected to the power or ground plane, so when power is connected to the VDD and VSS pads, the power is connected to the appropriate device pin.



**FIGURE 2-4:** *Jumpering the PCB pad to either VDD or VSS.*

# 14-Pin SOIC/DIP/TSSOP Evaluation Board User's Guide

## 2.4.3 Passive Components (R1X, R2X, R3X, C1X, R1, R2, C1, C2, C3, P1, P2, P3 and P4)

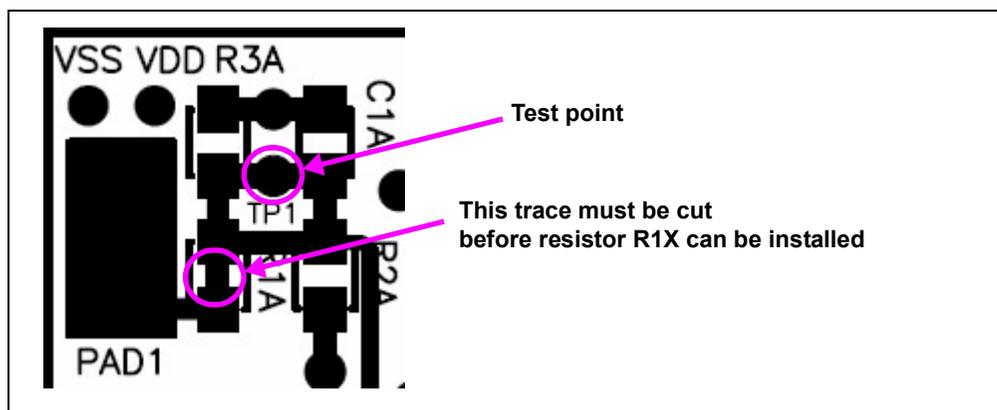
The footprints for these components are present to allow maximum flexibility in the use of this PCB to evaluate a wide range of 14-pin SOIC, DIP and TSSOP devices. The purpose of these components may vary depending on the device under evaluation and how it is to be used in the desired circuit. Refer to the device data sheet for the recommended components that should be used when evaluating that device.

- Component R1X allows an in-line resistor that can be installed between the device pin and the PCB pad. This may be required when interfacing this PCB to other circuits.
- Component R2X allows a pull-up resistor to be installed for the device pin.
- Component R3X allows a pull-down resistor to be installed for the device pin.
- Component C1X allows a capacitive load/filter to be installed for the device pin.
- Component C2 allows a power supply filtering capacitor to be installed.
- Components C3 and C4 allow a device filtering capacitor to be installed.
- Components P1, P2, P3, P4, P5, P6, P7 and P8 are not connected and give a footprint (805 surface-mount) for a passive component (resistor, capacitor, etc.) to be installed and jumpered into the PCB circuit. This allows for the evaluation of some simple device circuits to be implemented on this PCB.

## 2.4.4 Installing Resistor R1X

Resistor R1X is shorted by default. Therefore, if resistor R1X is to be installed, the trace across the component must be cut before it is installed (see Figure 2-5).

While evaluating a device, it may be desirable to see the signals on both sides of this resistor. A test point is available so that both signals may be monitored. This test point is the avenue between components R3x and C1x (see Figure 2-5).



**FIGURE 2-5:** Test point when resistor R1X is installed.

## 2.4.5 Baseline Flash Microcontroller Programmer (BFMP) Interface (Header J1)

The BFMP interface allows a PICmicro MCU device to be programmed with programmers that support this interface, such as the BFMP programmer (part number PG164101).

**TABLE 2-2: BFMP HEADER SIGNALS AND PICMICRO MCU PINS**

BFMP Header Signal		14-pin PICmicro <sup>®</sup> MCU Pin Number	Comment
Name	Number		
—	1	—	
CLK	2	12	ICSP™ Clock
DT	3	13	ICSP Data
VSS	4	14	
VDD	5	1	
VPP	6	4	ICSP Programming Voltage

# 14-Pin SOIC/DIP/TSSOP Evaluation Board User's Guide

---

## 2.4.6 The PCB as a SOIC-14 or TSSOP-14 to DIP-14 Socket Converter

There may be occasions when it is desirable to convert the footprint of the device to that of a DIP package. This allows the device to be installed into an existing DIP socket. Two 1x7 row pins need to be installed into the PCB's DIP footprint when the device is installed into the appropriate package footprint.

This allows the PCB to convert the SOIC-14 or TSSOP-14 footprints to a 300-mil DIP-14 footprint.

## 2.4.7 Evaluating a Digital Potentiometer Device

### 2.4.7.1 DIGITAL POTENTIOMETER

The following digital potentiometers are supported by this evaluation board.

**TABLE 2-3: 14-PIN DIGITAL POTENTIOMETERS**

Device	SOIC	DIP	TSSOP	Comment
MCP42010	Yes	Yes	Yes	
MCP42050	Yes	Yes	Yes	
MCP42100	Yes	Yes	Yes	

---

---

## Appendix A. Schematic and Layouts

---

---

### A.1 INTRODUCTION

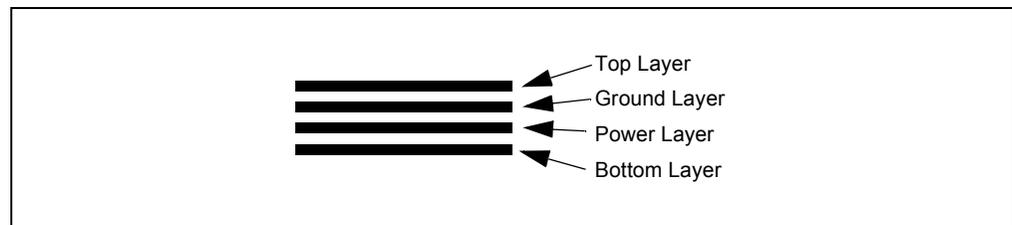
This appendix contains the schematics and layouts for the 14-Pin SOIC/DIP/TSSOP Evaluation Board. Diagrams included in this appendix:

- Board Schematic - Digital Circuitry
- Board – Top Layer + Bottom Layer + Silk-Screen
- Board – Top Layer + Silk-Screen
- Board – Bottom Layer
- Board – Power Plane
- Board – Ground Plane
- Board – Component Layer

### A.2 SCHEMATICS AND PCB LAYOUT

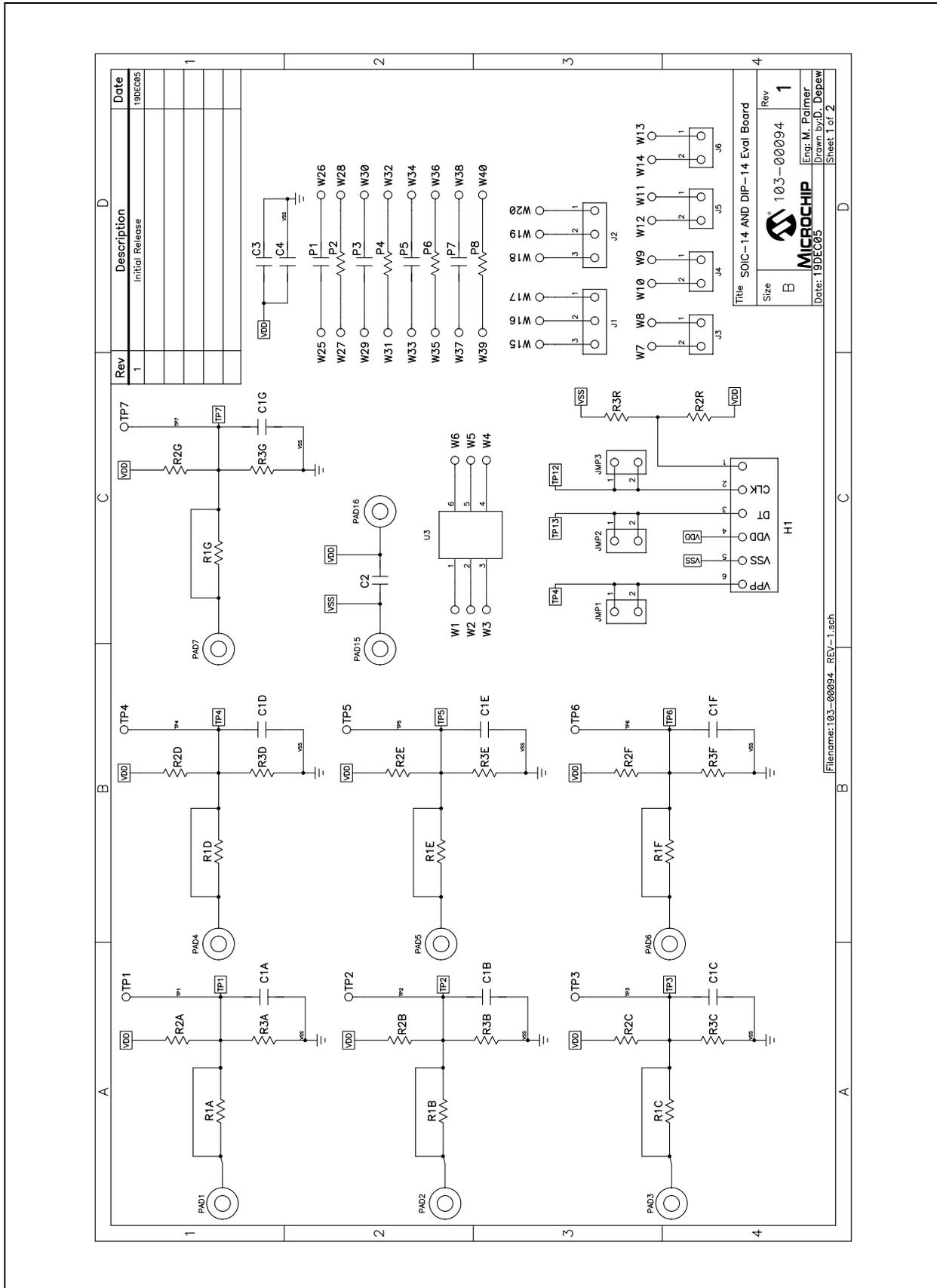
Figure A-4 shows the schematic of the 14-Pin SOIC/DIP/TSSOP Evaluation Board.

Figure A-2 shows the layout for the top layer of the 14-Pin SOIC/DIP/TSSOP Evaluation Board. The layer order is shown in Figure A-1.

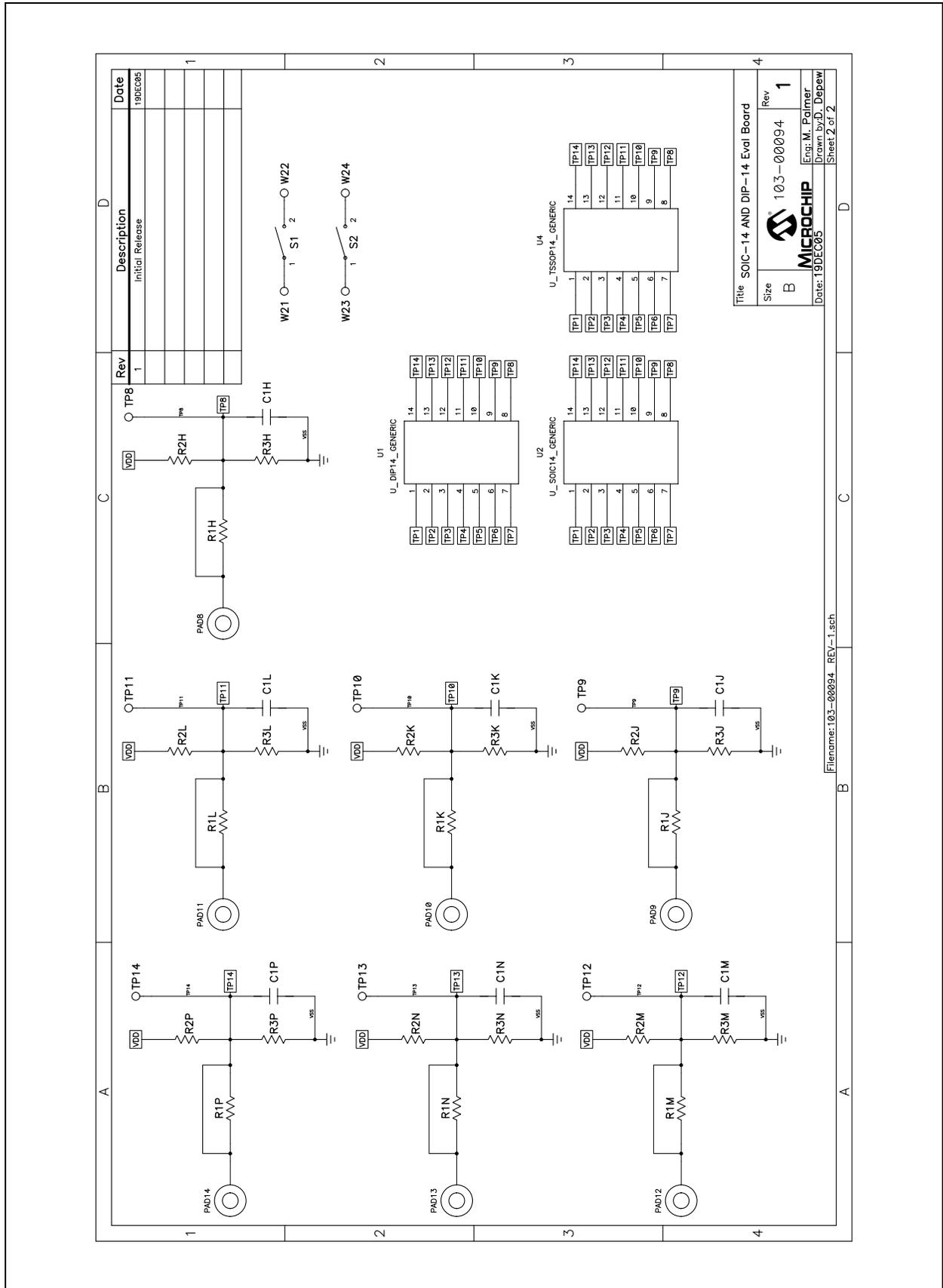


**FIGURE A-1:** *Layer Order.*

# 14-Pin SOIC/DIP/TSSOP Evaluation Board User's Guide



**FIGURE A-2:** Board Schematic - Digital Circuitry (Page 1).



**FIGURE A-3:** Board Schematic - Digital Circuitry (Page 2).

# 14-Pin SOIC/DIP/TSSOP Evaluation Board User's Guide

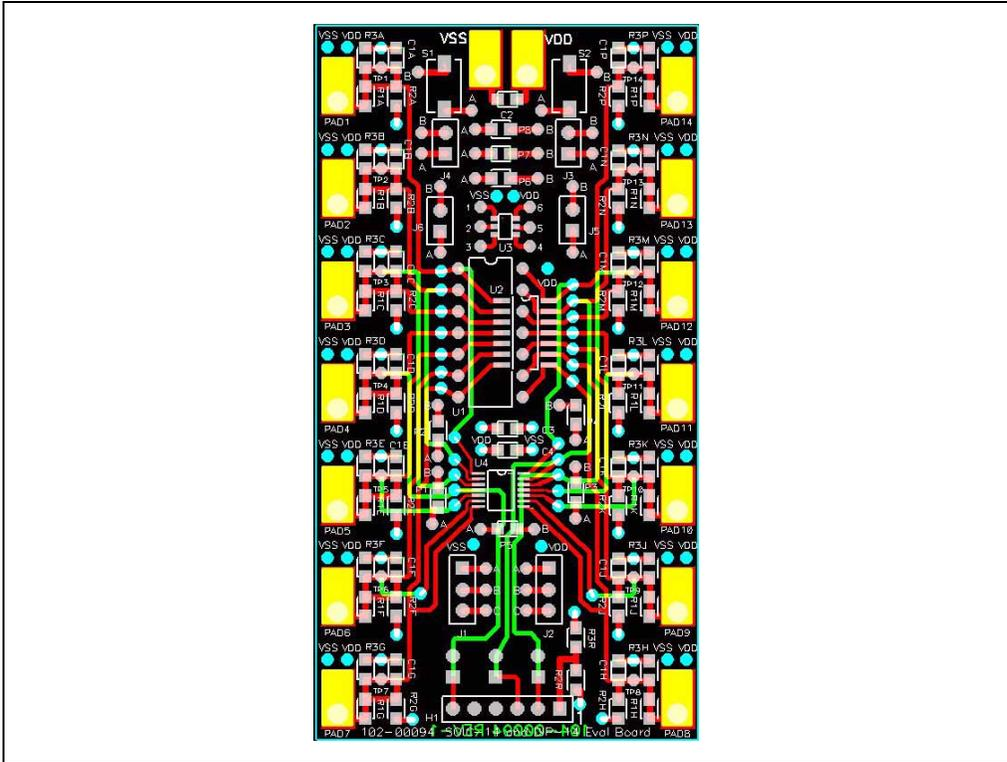
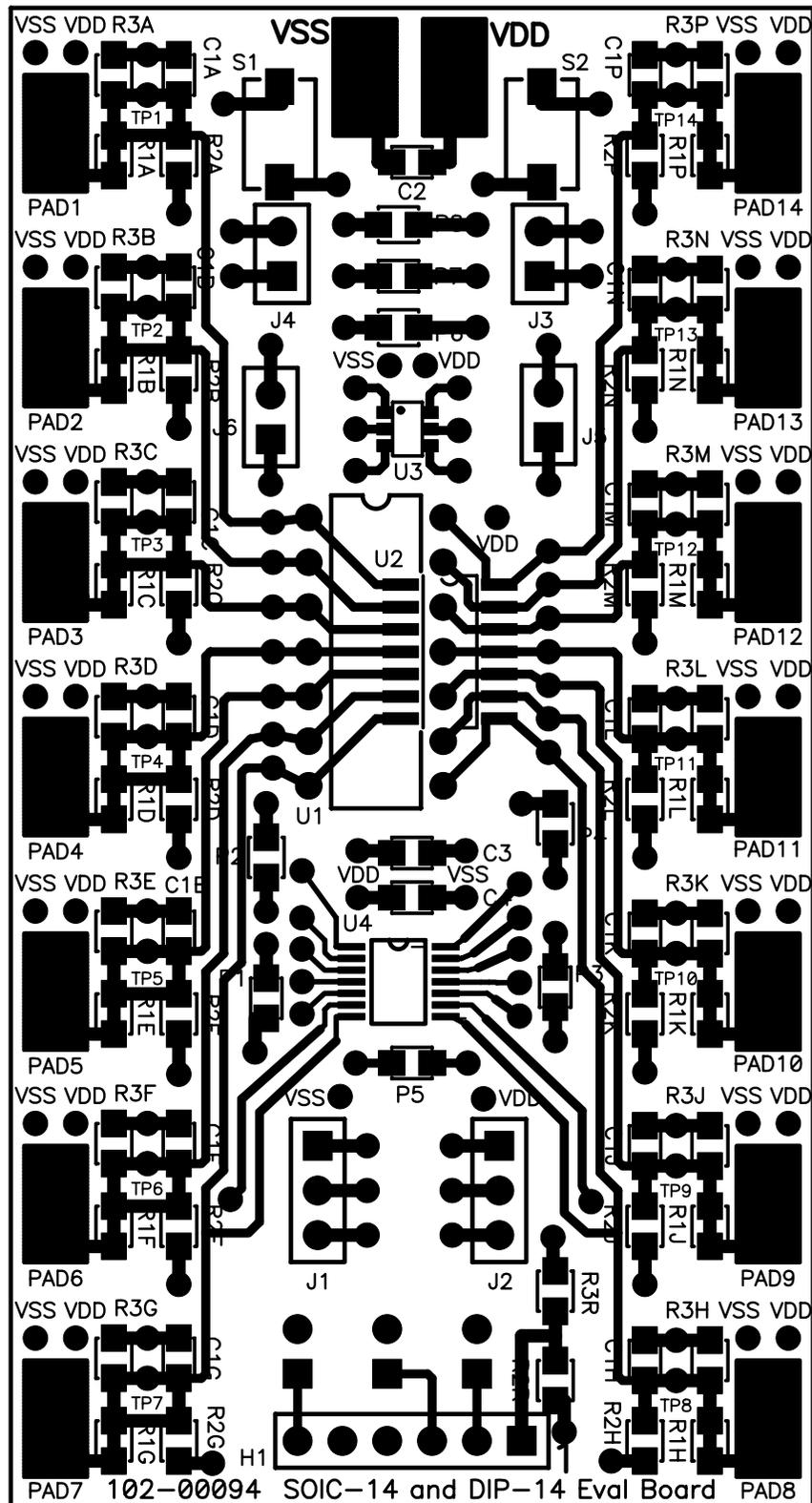


FIGURE A-4: Board Layout – Top Layer + Bottom Layer + Silk-Screen.



**FIGURE A-5:** Board Layout – Top Layer + Silk-Screen.

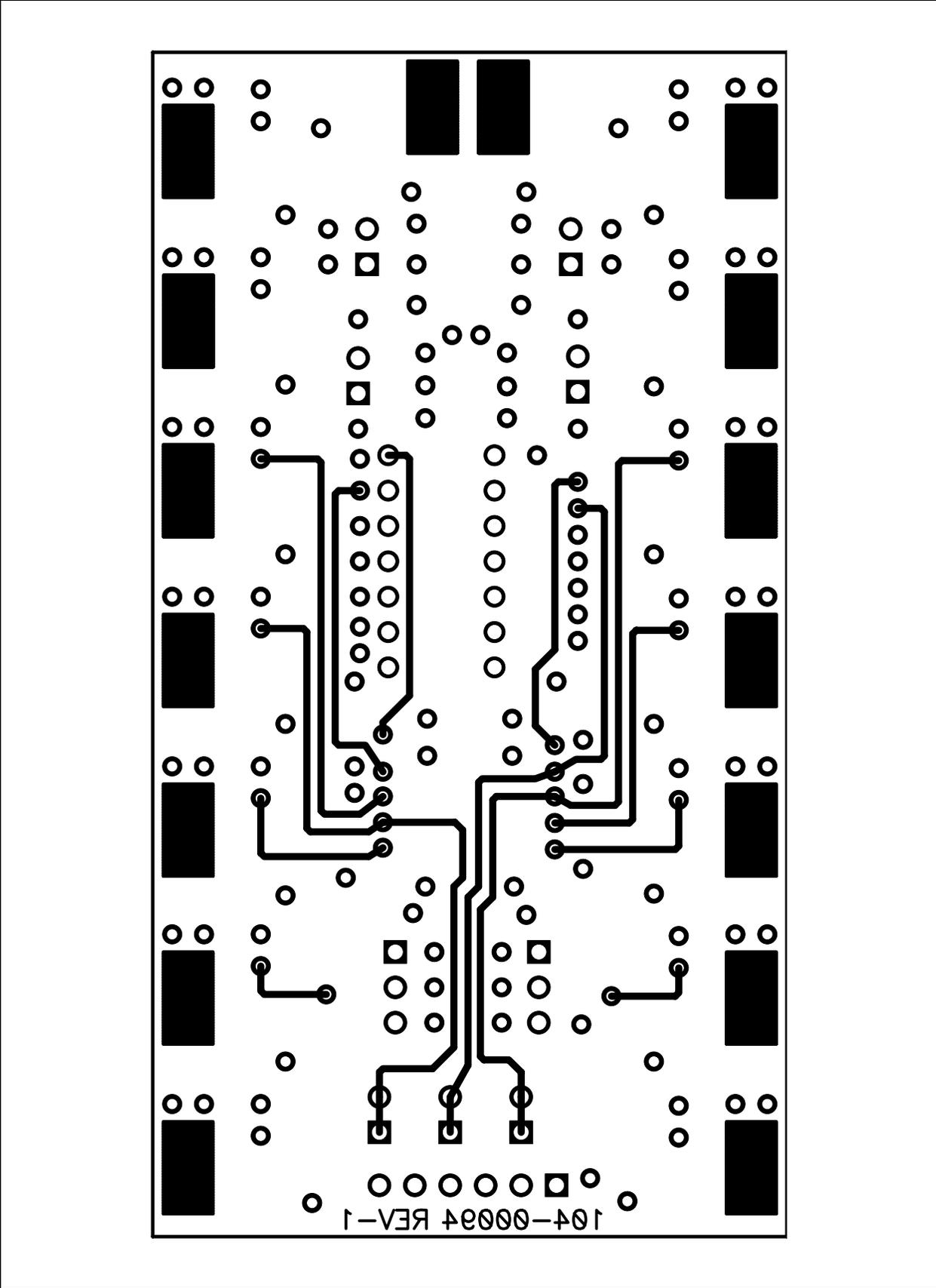
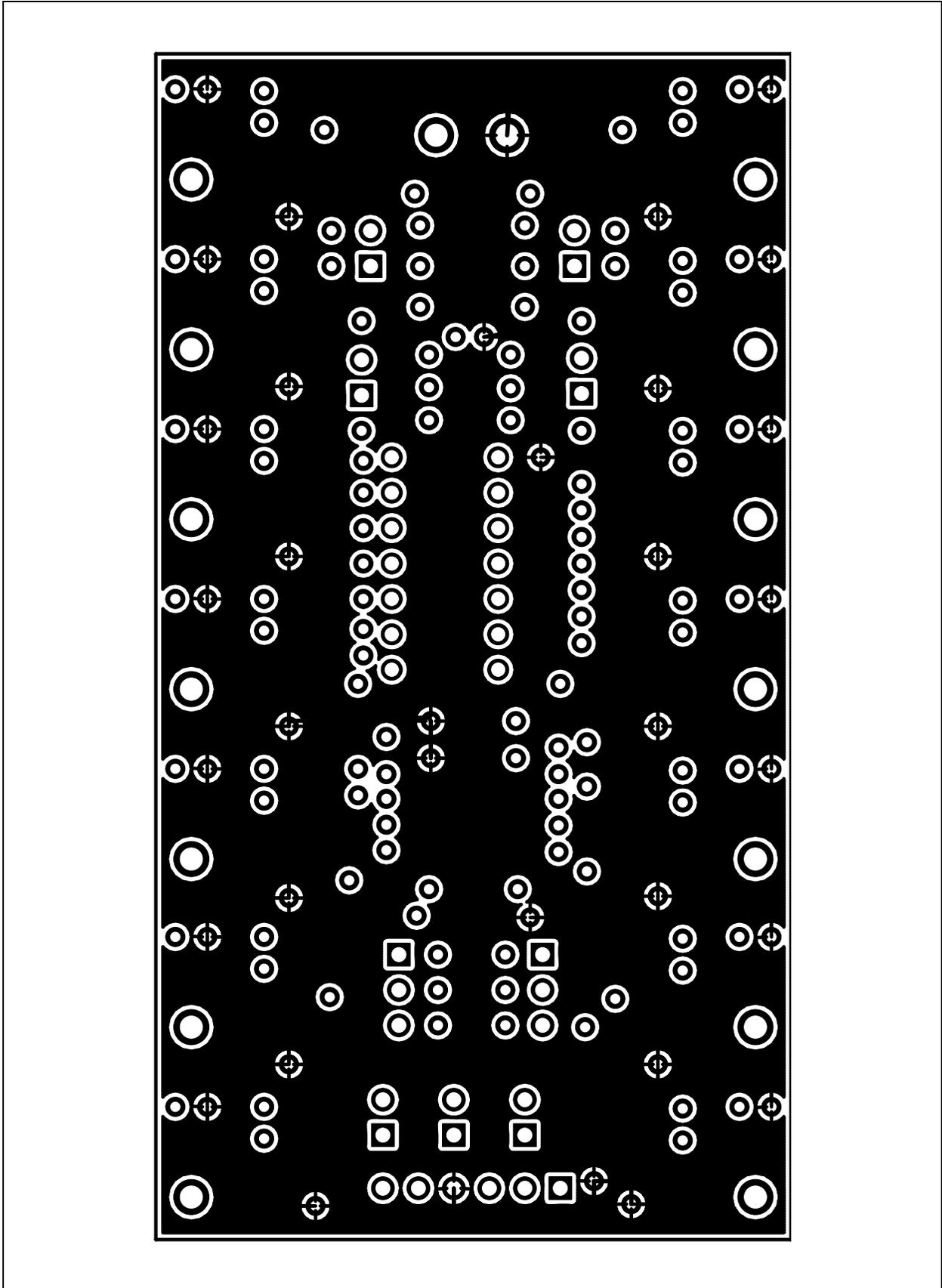
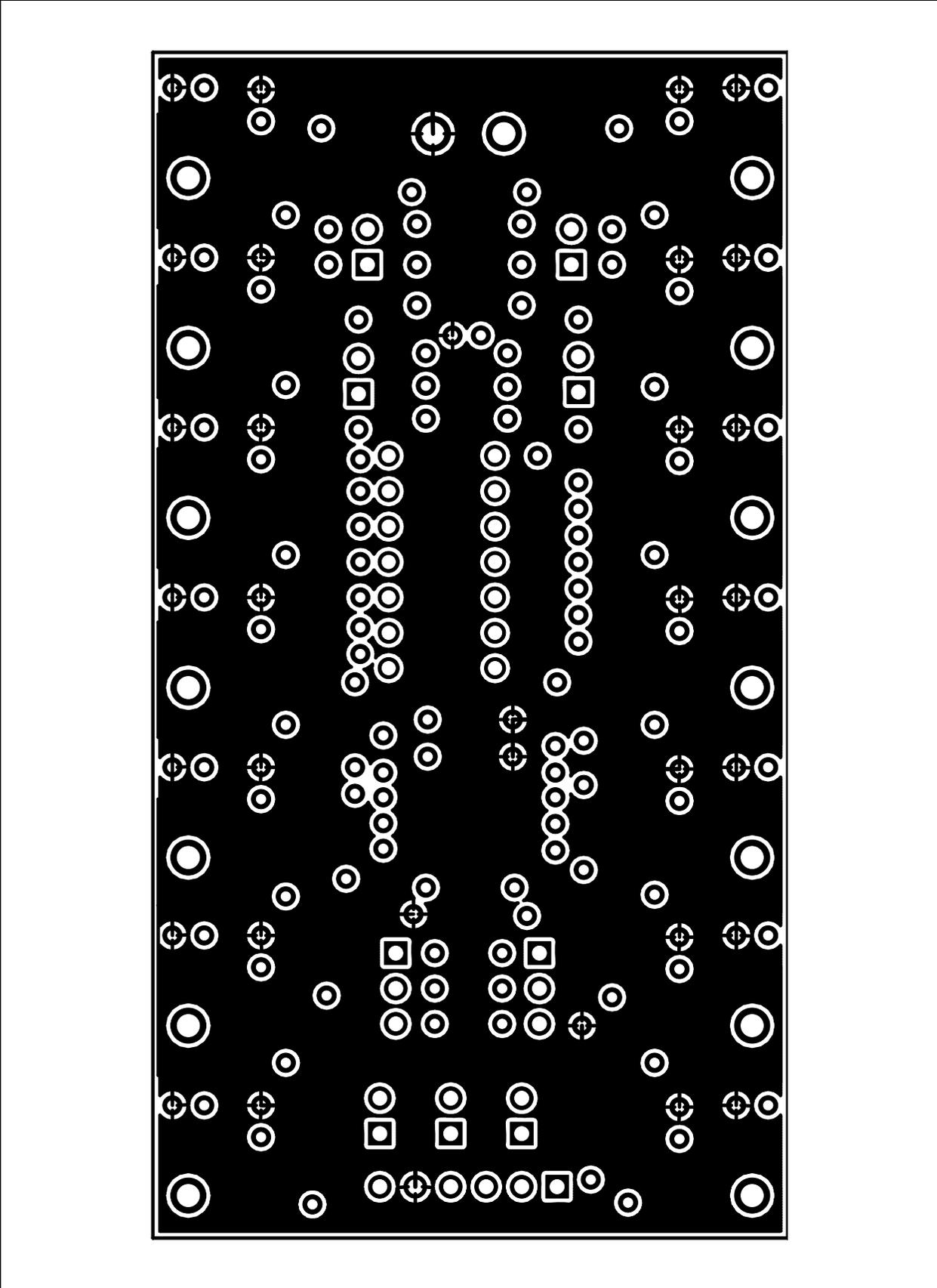


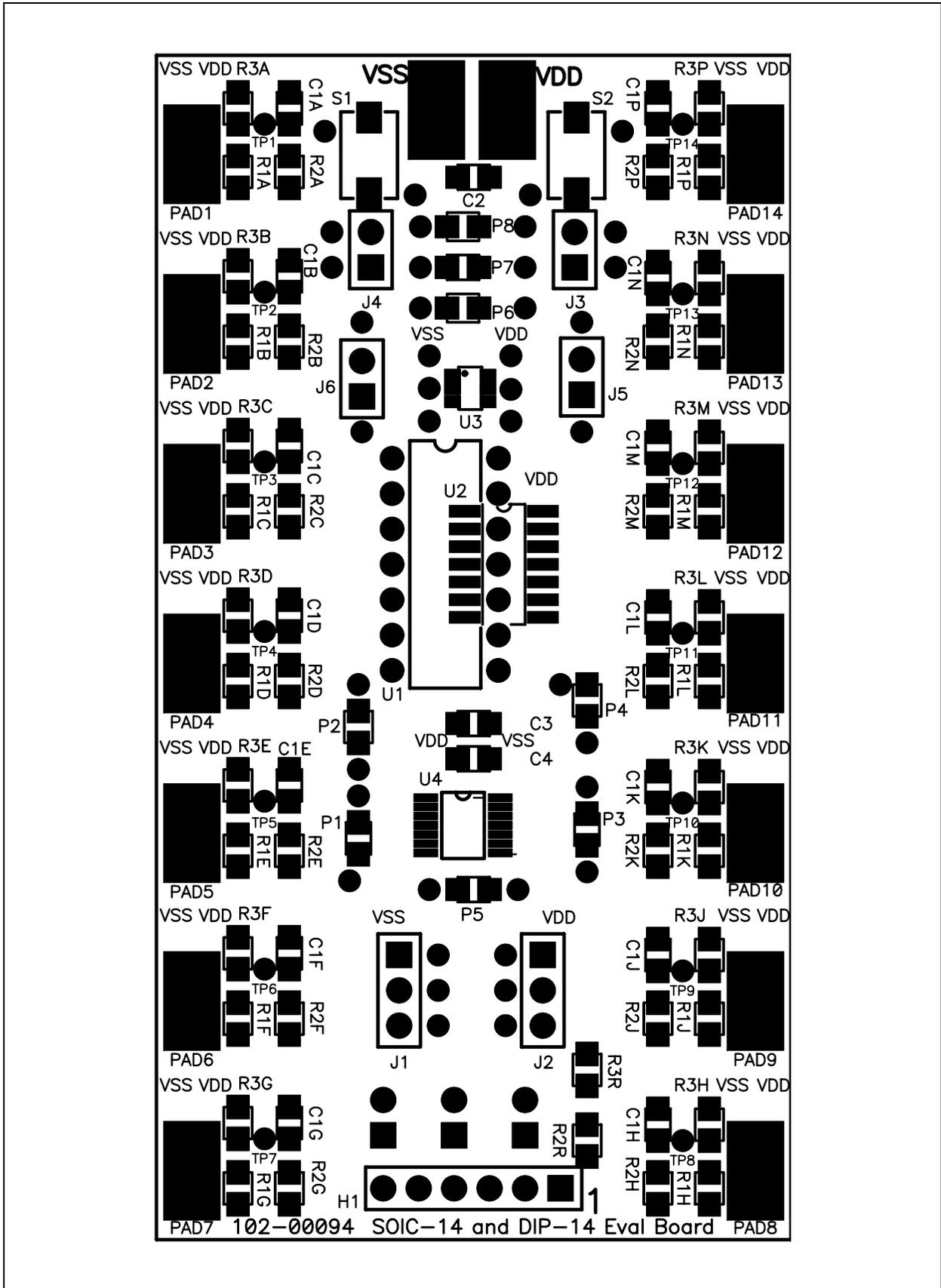
FIGURE A-6: Board Layout – Bottom Layer.



**FIGURE A-7:** Board Layout – Power Plane.

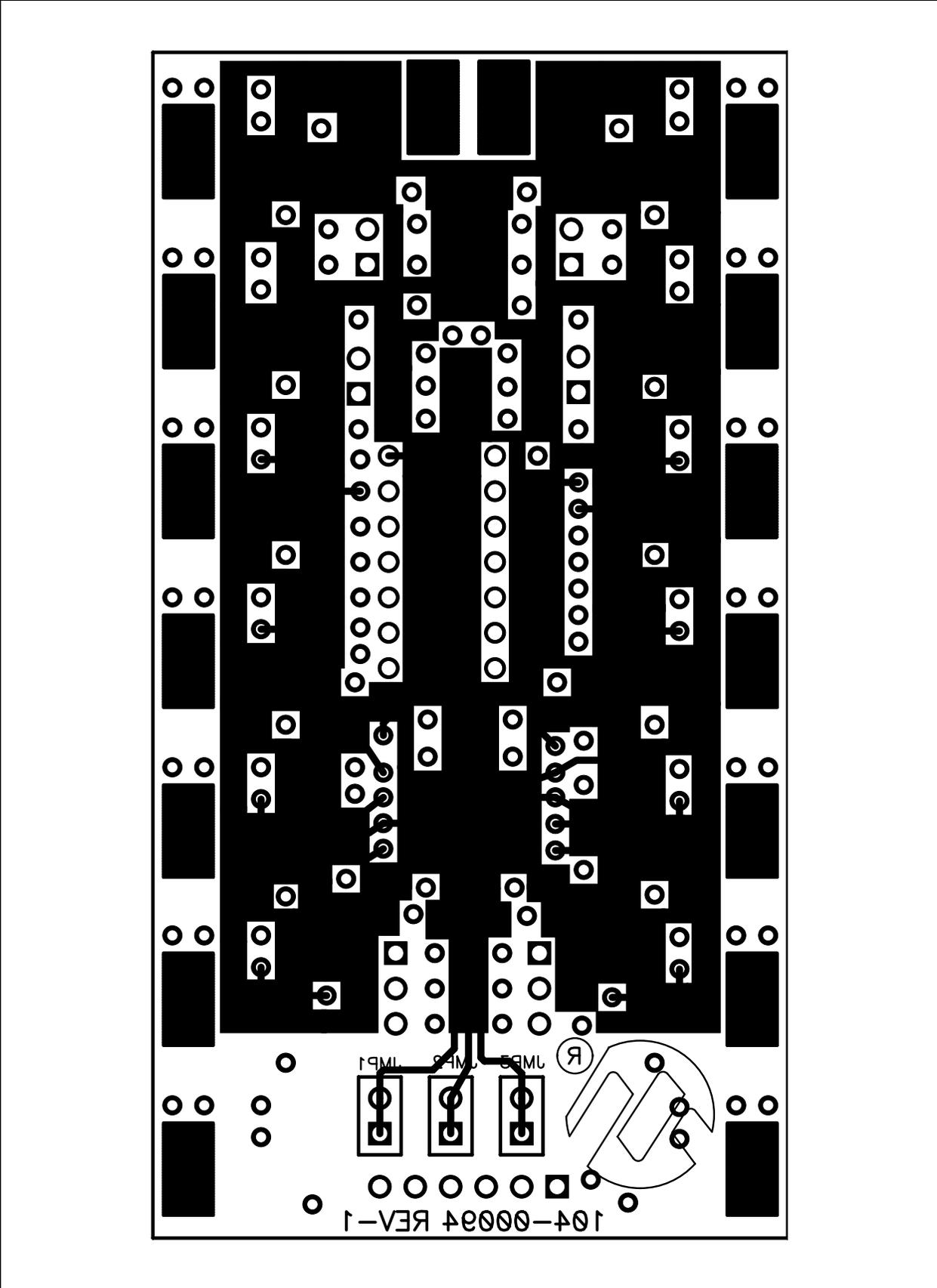


**FIGURE A-8:** Board Layout – Ground Plane.

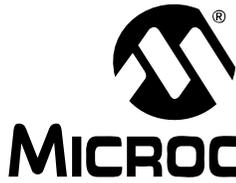


**FIGURE A-9:** Board Layout – Component Layer.

# 14-Pin SOIC/DIP/TSSOP Evaluation Board User's Guide



**FIGURE A-10:** Board Layout – Bottom Silk.



**Appendix B. Bill Of Materials (BOM)**

**TABLE B-1: BILL OF MATERIALS**

Qty	Reference	Description	Manufacturer	Part Number
1	PCB 103-00094	SOT23 Evaluation Board PCB	Microchip Technology Inc.	103-00094
0	U1	DIP-14 Device	Microchip Technology Inc.	User-specified
0	U2	SOIC-14 Device	Microchip Technology Inc.	User-specified
0	U3	SOT-23-6 Device	Microchip Technology Inc.	User-specified
0	U4	TSSOP-14 Device	Microchip Technology Inc.	User-specified
0	C2, C3, C4	Device Power Supply Bypass Capacitor Surface-mount (805 package) (Optional - Application-dependent)	—	User-specified
0	C1A, C1B, C1C, C1D, C1E, C1F, C1G, C1H, C1J, C1K, C1L, C1M, C1N, C1P	Output Filter Capacitor Surface-mount (805 package) (Optional - Application-dependent)	—	User-specified
0	R1A, R1B, R1C, R1D, R1E, R1F, R1G, R1H, R1J, R1K, R1L, R1M, R1N, R1P	Output inline resistor Surface-mount (805 package) (Optional - Application-dependent)	—	User-specified
0	R2A, R2B, R2C, R2D, R2E, R2F, R2G, R2H, R2J, R2K, R2L, R2M, R2N, R2P	Output Pull-up resistor Surface-mount (805 package) (Optional - Application-dependent)	—	User-specified
0	R3A, R3B, R3C, R3D, R3E, R3F, R3G, R3H, R3J, R3K, R3L, R3M, R3N, R3P	Output Pull-down resistor Surface-mount (805 package) (Optional - Application-dependent)	—	User-specified
0	P1, P2, P3, P4, P5, P6, P7, P8	Passive component (not connected) that can be "blue wired" into the desired circuit. The device layout supports the 805 package. (Optional - Application-dependent)	—	—
0	H1	BFMP Header (6-pin, 100 mil spacing)	—	—
0	J1, J2	1x3 Jumper Stakes (male)	Jameco ValuePro	7000-1x35G
0	J3, J4, J5, J6	1x2 Jumper Stakes (male)	Jameco ValuePro	7000-1x25G
0	PAD1, PAD2, PAD3, PAD4, PAD5, PAD6, PAD7, PAD8, PAD9, PAD10, PAD11, PAD12, PAD13, PAD14, VDD, VSS	Through-hole connectors	Keystone Electronics®	5012

# 14-Pin SOIC/DIP/TSSOP Evaluation Board User's Guide

---

TABLE B-1: BILL OF MATERIALS (CONTINUED)

Qty	Reference	Description	Manufacturer	Part Number
0	PAD1, PAD2, PAD3, PAD4, PAD5, PAD6, PAD7, PAD8, PAD9, PAD10, PAD11, PAD12, PAD13, PAD14, VDD, VSS	Surface-mount connectors	Keystone Electronics®	5016
0	S1, S2	Surface Mount Switch	Panasonic®	EVQ-PJS04K



**MICROCHIP**

# 14-PIN SOIC/DIP/TSSOP EVALUATION BOARD USER'S GUIDE

---

---

## Appendix C. Microchip Analog and Interface Device Compatibility

---

---

### C.1 INTRODUCTION

This appendix documents the Microchip Analog and Interface devices that are footprint compatible with the 14-Pin SOIC/DIP/TSSOP Evaluation Board.

The Analog and Interface devices currently fall into the following categories:

- A/D Converters (ADCs)
- Battery Chargers
- Comparators
- D/A Converters (DACs)
- DC-to-DC Converters
- Digital Potentiometers (Digi-Pots)
- Fan Controllers
- Integrated Devices
- Interface Devices
- Linear Regulators
- Operational Amplifiers (Op Amps)
- Power MOSFET Drivers
- Programmable Gain Amplifiers (PGAs)
- Switching Regulators
- Temperature Sensors
- Voltage Supervisors and Voltage Detectors

Table C-1 shows the Microchip Analog and Interface devices that are currently supported. As new devices become available, this PCB may be able to support them. Please check the device data sheet to verify if the device is available in one of the package types supported by this PCB.

# 14-Pin SOIC/DIP/TSSOP Evaluation Board User's Guide

**TABLE C-1: ANALOG AND INTERFACE DEVICES  
PCB COMPATIBILITY<sup>(1, 2)</sup>**

Device	SOIC	DIP	TSSOP	Comment
<b>Digital Potentiometer</b>				
MCP42010	Yes	Yes	—	
MCP42050	Yes	Yes	—	
MCP42100	Yes	Yes	—	
<b>Operational Amplifiers (Op Amps)</b>				
MCP604	Yes	Yes	Yes	
MCP609	Yes	Yes	Yes	
MCP619	Yes	Yes	Yes	
MCP6004	Yes	Yes	Yes	
MCP6024	Yes	Yes	Yes	
MCP6044	Yes	Yes	Yes	
MCP6144	Yes	Yes	Yes	
MCP6234	Yes	Yes	Yes	
MCP6244	Yes	Yes	Yes	
MCP6274	Yes	Yes	Yes	
MCP6284	Yes	Yes	Yes	
MCP6294	Yes	Yes	Yes	
TC7650CPD	—	Yes	—	
TC7652CPD	—	Yes	—	
<b>Programmable Gain Amplifiers (PGAs)</b>				
MCP6S26	Yes	Yes	Yes	
<b>Comparators</b>				
MCP6544	Yes	Yes	Yes	
MCP6549	Yes	Yes	Yes	
<b>Voltage-to-Frequency</b>				
TC9400	Yes	Yes	—	
TC9401	—	Yes	—	
TC9402	—	Yes	—	
<b>Power MOSFET Drivers</b>				
TC4467	—	Yes	—	
TC4468	—	Yes	—	
TC4469	—	Yes	—	
<b>A/D Converters (ADCs)</b>				
MCP3004	Yes	Yes	Yes	
MCP3204	Yes	Yes	Yes	
MCP3302	Yes	Yes	Yes	
TC520A	—	Yes	—	
<b>D/A Converters (DACs)</b>				
MCP4922	Yes	Yes	Yes	
<b>Battery Chargers</b>				
PS810	—	—	Yes	

**Note 1:** Installation of PCB capacitor C2 (or C3) is recommended for all devices. See data sheet for recommended value.

**2:** Installation of PCB capacitor C1 recommended. See data sheet for recommended value.

# Microchip Analog and Interface Device Compatibility

**TABLE C-1: ANALOG AND INTERFACE DEVICES  
PCB COMPATIBILITY<sup>(1, 2)</sup> (CONTINUED)**

Device	SOIC	DIP	TSSOP	Comment
<b>Interface Devices</b>				
MCP2120	Yes	Yes	—	
MCP25020	Yes	Yes	—	
MCP25025	Yes	Yes	—	
MCP25050	Yes	Yes	—	
MCP25055	Yes	Yes	—	
<b>PICmicro<sup>®</sup> MCU's</b>				
PIC16F505	Yes	Yes	Yes	
PIC16F630	Yes	Yes	Yes	
PIC16F636	Yes	Yes	Yes	
PIC16F676	Yes	Yes	Yes	
PIC16F684	Yes	Yes	Yes	
PIC16F688	Yes	Yes	Yes	
<b>Voltage Supervisors and Voltage Detectors</b>				
None	—	—	—	
<b>Switching Regulator</b>				
None	—	—	—	
<b>DC-to-DC Converters</b>				
None	—	—	—	
<b>Linear Regulators</b>				
None	—	—	—	
<b>Voltage References</b>				
None	—	—	—	
<b>Temperature Sensors</b>				
None	—	—	—	
<b>Fan Controllers</b>				
None	—	—	—	
<b>Integrated Devices</b>				
None	—	—	—	
<b>PWM Controllers</b>				
None	—	—	—	

**Note 1:** Installation of PCB capacitor C2 (or C3) is recommended for all devices. See data sheet for recommended value.

**2:** Installation of PCB capacitor C1 recommended. See data sheet for recommended value.



---

---

## WORLDWIDE SALES AND SERVICE

---

---

### AMERICAS

#### Corporate Office

2355 West Chandler Blvd.  
Chandler, AZ 85224-6199  
Tel: 480-792-7200  
Fax: 480-792-7277  
Technical Support:  
<http://support.microchip.com>  
Web Address:  
[www.microchip.com](http://www.microchip.com)

#### Atlanta

Alpharetta, GA  
Tel: 770-640-0034  
Fax: 770-640-0307

#### Boston

Westborough, MA  
Tel: 774-760-0087  
Fax: 774-760-0088

#### Chicago

Itasca, IL  
Tel: 630-285-0071  
Fax: 630-285-0075

#### Dallas

Addison, TX  
Tel: 972-818-7423  
Fax: 972-818-2924

#### Detroit

Farmington Hills, MI  
Tel: 248-538-2250  
Fax: 248-538-2260

#### Kokomo

Kokomo, IN  
Tel: 765-864-8360  
Fax: 765-864-8387

#### Los Angeles

Mission Viejo, CA  
Tel: 949-462-9523  
Fax: 949-462-9608

#### San Jose

Mountain View, CA  
Tel: 650-215-1444  
Fax: 650-961-0286

#### Toronto

Mississauga, Ontario,  
Canada  
Tel: 905-673-0699  
Fax: 905-673-6509

### ASIA/PACIFIC

#### Australia - Sydney

Tel: 61-2-9868-6733  
Fax: 61-2-9868-6755

#### China - Beijing

Tel: 86-10-8528-2100  
Fax: 86-10-8528-2104

#### China - Chengdu

Tel: 86-28-8676-6200  
Fax: 86-28-8676-6599

#### China - Fuzhou

Tel: 86-591-8750-3506  
Fax: 86-591-8750-3521

#### China - Hong Kong SAR

Tel: 852-2401-1200  
Fax: 852-2401-3431

#### China - Qingdao

Tel: 86-532-8502-7355  
Fax: 86-532-8502-7205

#### China - Shanghai

Tel: 86-21-5407-5533  
Fax: 86-21-5407-5066

#### China - Shenyang

Tel: 86-24-2334-2829  
Fax: 86-24-2334-2393

#### China - Shenzhen

Tel: 86-755-8203-2660  
Fax: 86-755-8203-1760

#### China - Shunde

Tel: 86-757-2839-5507  
Fax: 86-757-2839-5571

#### China - Wuhan

Tel: 86-27-5980-5300  
Fax: 86-27-5980-5118

#### China - Xian

Tel: 86-29-8833-7250  
Fax: 86-29-8833-7256

### ASIA/PACIFIC

#### India - Bangalore

Tel: 91-80-2229-0061  
Fax: 91-80-2229-0062

#### India - New Delhi

Tel: 91-11-5160-8631  
Fax: 91-11-5160-8632

#### India - Pune

Tel: 91-20-2566-1512  
Fax: 91-20-2566-1513

#### Japan - Yokohama

Tel: 81-45-471-6166  
Fax: 81-45-471-6122

#### Korea - Gumi

Tel: 82-54-473-4301  
Fax: 82-54-473-4302

#### Korea - Seoul

Tel: 82-2-554-7200  
Fax: 82-2-558-5932 or  
82-2-558-5934

#### Malaysia - Penang

Tel: 60-4-646-8870  
Fax: 60-4-646-5086

#### Philippines - Manila

Tel: 63-2-634-9065  
Fax: 63-2-634-9069

#### Singapore

Tel: 65-6334-8870  
Fax: 65-6334-8850

#### Taiwan - Hsin Chu

Tel: 886-3-572-9526  
Fax: 886-3-572-6459

#### Taiwan - Kaohsiung

Tel: 886-7-536-4818  
Fax: 886-7-536-4803

#### Taiwan - Taipei

Tel: 886-2-2500-6610  
Fax: 886-2-2508-0102

#### Thailand - Bangkok

Tel: 66-2-694-1351  
Fax: 66-2-694-1350

### EUROPE

#### Austria - Wels

Tel: 43-7242-2244-399  
Fax: 43-7242-2244-393

#### Denmark - Copenhagen

Tel: 45-4450-2828  
Fax: 45-4485-2829

#### France - Paris

Tel: 33-1-69-53-63-20  
Fax: 33-1-69-30-90-79

#### Germany - Munich

Tel: 49-89-627-144-0  
Fax: 49-89-627-144-44

#### Italy - Milan

Tel: 39-0331-742611  
Fax: 39-0331-466781

#### Netherlands - Drunen

Tel: 31-416-690399  
Fax: 31-416-690340

#### Spain - Madrid

Tel: 34-91-708-08-90  
Fax: 34-91-708-08-91

#### UK - Wokingham

Tel: 44-118-921-5869  
Fax: 44-118-921-5820